

CNCmakers Limited

Address: No.168, Xiadu Road, Haizhu District, Guangzhou, China 510300

Email: info@CNCmakers.com

Website: www.CNCmakers.com

Tel: +86-138-24444158

Fax: +86-20-84185336

Series No.	Product type	Structure	LED dimension	Remark
GSK218MC	GSK218MC	Integral	10.4	LED dimension is 10.4 inch by default
	GSK218MC-U1	Integral	8.4	LED dimension is 8.4 inch by default
	GSK218MC-H	Horizontal	8.4	LED dimension is 8.4 inch by default
	GSK218MC-H2	Horizontal	10.4	LED dimension is 10.4 inch by default
	GSK218MC-V	Vertical	10.4	LED dimension is 10.4 inch by default

Wherein, GSK218MC, GSK218MC-H and GSK218MC-V have three communication interfaces such as the RS232, USB and network of which these interfaces are set on the front of the host.

GSK218MC-U1 owns only two communication interfaces such as the RS232 and USB; the USB interface set on the front of the host and the RS232 interface set on the back of the host.

SECURITY PRECAUTION



Accident may occur by improper operation! This system only can be operated by authorized and qualified personnel.

Especial prompt: The system power installed on (inside) the cabinet is the special-purpose one

Never attempt to use for other purposes by this power. Otherwise, tremendous hazard may occur!

STATEMENT!

- In this manual we have tried as much as possible to describe all various matters. However, we cannot describe all the matters which must not be done, or which cannot be done, because there are so many possibilities. Therefore, matters which are not especially described as possible in this manual should be regarded as “impossible”

WARNING!

- Thoroughly read this manual and user manual issued by the machine manufacturer, and strictly operate the machine based upon the requirement of this manual before installing, programming and operating the machine; otherwise, possibly causing damage to the product, machine itself, as well the obsolete workpiece or injury to the user.

NOTICE!

- The product functions and technical indexes (such as accuracy, velocity) described in this manual are only directed against this product. The CNC installed this product, the actual function configuration and the technical capacity are determined by the machine manufacturer; the function configurations of the CNC machine and technical indexes are subjected on the manual issued by the machine builder.

All specifications and designs are subject to change without notice.

SAFETY PRECAUTIONS

■ Transportation and Storage

- Do not pile up the carton over 6 layers.
- Do not climb, stand on the carton; do not place heavy objects on it.
- Do not drag or move the products using the cables connected with the product.
- Do not impact, scratch the panel and screen.
- Avoid from the damp, the sunshine and the rain on the product carton.

■ Unpacking inspection

- Check whether it is your purchased product after unpacking the carton.
- Check whether the product is damaged during transporting.
- Check whether the components are prepared or damaged comparing with the packing list.
- It is necessary to contact our company immediately if the product type is inconsistent with the packing list, lack of accessories or damage in transportation.

■ Wiring

- The person who executes the wiring and inspection should have the corresponding professional capacity.
- The product should be reliably grounded, and its resistance should be less than 0.1Ω and can not be used the neutral conductor (zero cable) to replace the ground wire.
- The wiring should be correct and firm, otherwise, possibly causing the malfunction in product or unexpected result.
- The surge absorb diode connected with the product should be linked based upon the described direction, otherwise, it may damage the product.
- Before Inserting/pulling out the plug or opening the main cabinet of the product, it

is important to cut off the product's power.

■ Inspection and maintenance

- Cut off the power before inspecting and maintaining or changing the components.
- Check the malfunction when the short-circuit or overloading occurs. The computer can be started after the malfunction is eliminated.
- Do not power ON/OFF frequently for the product, if you want to turn on the power again after power off, its interval time is 1min. at least.

Volume I Programming Description

Introduce the PLC's specification, address, basis code and function code of the GSK218MC series

Volume II Operation Description

Introduce the PLC's relative operation proceedings of GSK218MC series

Volume III Function Description

Introduce the PLC's main function of GSK218MC series

Volume IV Installation and Connection

Introduce the installation, connection and setting method of the GSK218MC series CNC system

Appendix

Introduce the ladder diagram user guide about the GSK218MC CNC system matching with the tool magazine

SECURITY RESPONSIBILITY

Security responsibility of the manufacturer

- Manufacturer should take responsibility for the design and structure danger of the motor and the accessories which have been eliminated and/or controlled.
- Manufacturer should take responsibility for the security of the motor and accessories.
- Manufacturer should take responsibility for the offered information and suggestions for the user.

Security responsibility of the users

- User should know and understand about the contents of security operations by learning and training the security operations of the CNC system.
- User should take responsibility for the danger because of increasing, changing or modifying the original CNC system or accessories by themselves.
- User should take responsibility for the danger without following the operations, maintenances, installations and storages described in the manual.

This manual is stored by the last user.

Sincerely thanks for your friendly supporting

CONTENTS

VOLUME I PROGRAMMING	1
CHAPTER ONE SEQUENCY PROGRAMMING COMPILATION SCHEDULE	2
1.1 GSK218MC Series PLC Specification	2
1.2 Concept of the Sequence Programming	2
1.3 Distribution Interface (Step one)	3
1.4 Ladder Diagram Compilation (Step two)	3
1.5 Sequence Programming Debugging (Step 3)	3
CHAPTER TWO SEQUENCE PROGRAMMING.....	5
2.1 Performance Process of Sequence Programming	5
2.2 Cycle Performance	6
2.3 Priority Sequence of the Execution (the 1 st Level, the 2 nd level).....	6
2.4 Sequence Program Structure	7
2.5 Input/output Signal Treatment.....	9
2.5.1 Input Signal Treatment.....	9
2.5.2 Treatment of the Output Signal	10
2.5.3 Distinguish of Signal State Between 1st Level and 2nd Program.....	10
2.6 Interlocking	11
CHAPTER THREE PLC ADDRESS	13
3.1 Machine → PLC address (X)	13
3.1.1 X Address on I/O Input.....	14
3.1.2 X Address on MDI Panel.....	14
3.2 PLC → Address of Machine Tool Side (Y)	16
3.2.1 Y Address on I/O Output Port	16
3.3 PLC →CNC Address (G).....	18
3.4 CNC →PLC Address (F)	19
3.5 Internal Replay Address (R).....	19
3.6 Nonvolatile Relay Address (K).....	20
3.7 Information Display Request Address (A)	20
3.8 Counter Address (C)	21
3.9 Counter Preset Value Address (DC).....	21
3.10 Timer Address (T)	21
3.11 Presetting Value Address of Timer (DT).....	21
3.12 Data Table Address (D).....	21
3.13 Address Mark (L).....	21
3.14 Subprogram Number (P)	22
CHAPTER FOUR PLC BASIS CODE.....	23
4.1 RD, RD.NOT, WRT, and WRT.NOT Codes	23
4.2 AND, AND.NOT Codes	24
4.3 OR, OR.NOT Codes	25

4.4	OR. STK Code	25
4.5	AND. STK Code	26
CHAPTER FIVE PLC FUNCTION CODE.....		27
5.1	END1 (The 1 st Level Sequence Program End)	28
5.2	END2 (The 2 nd Sequence Program End)	28
5.3	CALL (Call Subprogram)	28
5.4	CALLU (Unconditionally Call Subprogram)	29
5.5	SP (Subprogram)	30
5.6	SPE (End of Subprogram).....	30
5.7	SET (Replacement/Setting)	31
5.8	RST (Resetting)	31
5.9	JMPB (Mark Number Skip).....	32
5.10	LBL (Mark Number)	33
5.11	TMR (Timer).....	33
5.12	TMRB (Fixed Timer).....	34
5.13	TMRC (TIMER).....	35
5.14	CTR (Binary Counter)	36
5.15	DEC (Binary Decoding).....	38
5.16	COD (Binary System Code Conversion)	39
5.17	COM (Concentric Line Control)	40
5.18	COME (Concentric Line Control End).....	41
5.19	ROT (Binary Rotation Control)	41
5.20	SFT (Register Displacement/Shifting).....	44
5.21	DIFU (Rising Edge Detection)	45
5.22	DIFD (Descending Edge Detection)	46
5.23	COMP (Comparison of Binary Number).....	47
5.24	COIN (Consistency Comparison).....	48
5.25	MOVN (Data Transmission)	48
5.26	MOVB (Transmission of 1 Byte).....	49
5.27	MOVW (Transmission of Two Bytes).....	50
5.28	XMOV (Binary Indexed Data Transmission)	51
5.29	DSCH (Binary Data Index)	52
5.30	ADD (Binary Addition)	53
5.31	SUB (Binary Subtraction)	54
5.32	ANDF (Bit-by-bit AND).....	55
5.33	ORF (Bit-by-bit OR)	56
5.34	NOT (Bit-by-bit NOT).....	57
5.35	EOR (Exclusive OR)	58
CHAPTER SIX COMPILATION LIMIT OF LADDER DIAGRAM.....		60
VOLUME II OPERATION EXPLANATION		62
CHAPTER ONE PLC INTERFACE DISPLAY		64
1.1	GSK218MC Series Automatic Operation in PLC ON.....	64
1.2	Program-Controlled Interface Display	64

1.2.1	INFO Interface	64
1.2.2	PLCGRA Interface	66
1.2.3	PLCPAR Interface.....	66
1.2.4	PLCDGN Interface.....	67
1.2.5	PLCTRAE Interface	68
CHAPTER TWO PLC PROGRAMMING OPERATION.....		72
2.1	Brief	72
2.2	Basis Code	73
2.3	Operation Explanation of Ladder Diagram	74
2.4	Function Code	77
2.5	Command Table.....	78
2.6	Compilation Command	79
2.7	PLC Operation Steps.....	80
CHAPTER THREE PLC ADDRESS AND PARAMETER SETTING.....		82
3.1	Nonvolatile/Hold Relay	82
3.2	Timer	84
3.3	Data List.....	85
3.4	Counter	86
3.5	M function corresponding to F address	87
CHAPTER FOUR USER EXPLANATION OF LADDER DIAGRAM SOFTWARE EDIT.....		90
4.1	Brief	90
4.2	Software Introduction.....	90
4.2.1	Software Start	90
4.2.2	Function Introduction	91
4.3	Software Operation	92
4.3.1	Toolbar	92
4.3.2	Selection of Figure.....	94
4.3.3	Editing of Figure.....	95
4.3.4	Ladder Diagram Note.....	96
4.3.5	Leading-out.....	98
VOLUME III FUNCTION EXPLANATION		100
CHAPTER ONE CONTROLLABLE AXIS.....		102
1.1	Output of Axis Movement	102
1.2	Servo Signal Ready.....	103
CHAPTER TWO OPERATION PREPARATION.....		104
2.1	ESP	104
2.2	CNC Overtravel Signal	104
2.3	Alarm Signal	105
2.4	Selection of Operation Method	106
2.5	State Signal Output	106

CHAPTER THREE MANUAL OPERATION..... 108

 3.1 JOG Feed/Incremental Feed 108

CHAPTER FOUR REFERENCE POSITION RETURN..... 112

 4.1 Manual Reference Position Return 112

 4.2 Return to Reference Position Detection Signal 113

 4.3 Area Detection Signal 114

CHAPTER FIVE AUTOMATICAL OPERATION 116

 5.1 Cycle Start/ Feed Dwell 116

 5.2 Resetting 118

 5.3 Program Testing 119

 5.3.1 Machine Tool Lock119

 5.3.2 Dry Run119

 5.3.3 Single Block 120

 5.4 Skip Optional Block 121

 5.5 Program Restart 122

CHAPTER SIX FEEDRATE CONTROL 124

 6.1 Rapid Traverse Rate 124

 6.2 Feedrate Override..... 124

 6.3 Override Cancellation..... 125

CHAPTER SEVEN MISCELLANEOUS FUNCTION..... 126

 7.1 M Code Miscellaneous Function 126

 7.2 S Code Miscellaneous Function..... 127

 7.3 T Code Miscellaneous Function..... 128

 7.4 Miscellaneous Function Lock 132

CHAPTER EIGHT SPINDLE VELOCITY FUNCTION..... 134

 8.1 Spindle Velocity Control Method..... 134

 8.1.1 Gear Spindle 134

 8.1.2 Analog Spindle 134

 8.2 Rigid Tapping..... 136

CHAPTER NINE PROGRAMMING CODE..... 138

 9.1 User Macro Program 138

 9.2 Canned Cycle 140

CHAPTER TEN DISPLAY/SETTING 142

 10.1 Clock Function 142

 10.2 Operation Record Display..... 142

 10.3 Help Function 142

CHAPTER ELEVEN MEASURING 144

 11.1 Skip Function..... 144

CHAPTER TWELVE PANEL LOCK SETTING 146

VOLUME IV INSTALLATION & CONNECTION..... 157

CHAPTER ONE SYSTEM CONFIGURATION & INSTALLATION	159
1.1 System Composition	159
1.2 System Installation and Connection	159
1.3 CNC System Appearance Installation Dimension Figure	161
1.4 Additional Panel Figure.....	167
CHAPTER TWO CONNECTION BETWEEN EQUIPMENTS.....	169
2.1 Connection Diagram of External System.....	169
2.1.1 Layout of Interface Position	169
2.1.2 Pulse Servo Connection Schematic.....	171
2.1.3 Bus Servo Connection Schematic	172
2.1.4 Five-Linkage Servo Connection Schematic Using Bus Technology	173
2.2 Connection Between System and Drive Unit.....	174
2.2.1 System Interface Figure.....	174
2.2.2 Interface Signal List	174
2.2.3 Signal Explanation	175
2.2.4 Cable Connection Figure	177
2.2.5 GSK-LINK Cable Connection Figure	179
2.2.6 External Wiring Figure of GL100 Bus Extension Module	181
2.3 RS232 Standard Series Interfaces	182
2.4 Connection of MPG/Hand Unit.....	183
2.4.1 Interface Signal Figure.....	183
2.4.2 Explanation of Interface Signal	183
2.5 Connection of Spindle Unit.....	186
2.5.1 Interface Signal Table	186
2.5.2 Explanation of Interface Signal	186
2.5.3 Cable Connection Figure	187
2.6 System Power Interface	189
2.7 External Power Control Interface	189
2.8 Connection of Communication Cable.....	189
CHAPTER THREE I/O INTERFACE OF MACHINE CONTROL.....	191
3.1 Interface Signal Table	191
3.2 Interface Input.....	191
3.2.1 Interface Circuit Input.....	191
3.2.2 Interface Circuit of Hand Unit.....	192
3.2.3 Interface Definition of Signal Input.....	193
3.3 Interface Output	196
3.3.1 Interface Circuit Output.....	196
3.3.2 Interface Definition of Signal Output	197
CHAPTER FOUR MACHINE DEBUGGING	199
4.1 Debugging Preparation	199
4.2 System Power-ON.....	200
4.3 ESP and Limit.....	200
4.4 Gear Ratio Adjustment	202

4.5 Backlash Compensation 204

4.6 Setting Related with Drive unit 205

4.7 Machine Tool Pitch Compensation..... 206

4.8 Mechanical Zero Return (Machine Zero Return)..... 213

4.8.1 Mechanical Zero Return in Pulse Method 214

4.8.2 Servo Zero Return Function Setting of Bus Type..... 217

4.9 Input/Output Signal Control of Spindle Positive/Negative 223

4.10 Spindle Automatic Gear-shift Control 225

4.11 External Cycle Start & Feed Hold..... 227

4.12 External Editing Lock and the External Operation Panel Lock 228

4.13 Cooling, Lubrication and Chip-Removal Control..... 228

4.14 Setting Related to Feedrate 229

4.15 Setting Related with Tapping Parameter 231

4.16 Setting for the 4th Axis 234

4.17 Setting About the Bus Servo..... 236

APPENDIX 243

APPENDIX I LADDER DIAGRAM USAGE GUIDE OF GSK218MC SERIES WITH CONE TYPE TOOL-MAGAZINE..... 245

I. Cautions When Using the Cone Type Tool-Magazine Ladder Diagram .. 245

II. Configuration and Definition of PLC I/O Address and Internal Software Components 245

III. The Usage and Maintenance of the Cone Tool Magazine..... 270

IV. The Macro Note Matching with the Cone Tool Magazine..... 278

APPENDIX II LADDER DIAGRAM USE GUIDE OF GSK218MC SERIES MATCHING WITH DISC TOOL MAGAZINE..... 281

I. The application precautions of the disc tool magazine 281

II. The Configuration and Definition of the PLC I/O Address and Internal Soft Component 281

III. The Usage and Maintenance with Manipulator Tool Magazine..... 310

IV. Macro Note with Disk Tool Magazine 317

APPENDIX III FILE FORMAT OF LADDER DIAGRAM CONFIGURATION..... 319

I. F Signal and Meaning of the M Code M00---M99 319

II. That the “%” Takes One Single Line Means that the M code Information Storage is End 319

III. The Code and Meaning of the X Signal X0.0---X6.7 319

IV. The Code and Meaning of the Y Signal Y0.0---Y5.7 320

V. The Code and Meaning of the K Signal K6.0---K63.7 320

VI. The Code and Meaning of the A Signal A0.0---A31.7 320

VII. end//End Mark..... 320

VOLUME I PROGRAMMING

CHAPTER ONE SEQUENCY PROGRAMMING COMPILATION

SCHEDULE

1.1 GSK218MC Series PLC Specification

GSK218MC series PLC specification is shown below:

Table 1-1-1

Specification	GSK218MC Series PLC
Programming language	Ladder
Program level	2
The 1 st level program execution cycle	8ms
Basis code average treatment time	5 μ s
Programming capacity	4700 steps
Code	Basis code + function code
Internal relay (R)	0~511 (byte)
PLC alarm detection (A)	0~31 (byte)
Nonvolatile memory area	
Timer (T)	0~127 (word)
Counter (C)	0~127 (word)
Data base (D)	0~255 (word)
Nonvolatile relay (K)	0~63 (byte)
Counter prevalue data register (DC)	0~127 (word)
Timer prevalue data register (DT)	0~127 (word)
Subprogram (P)	0~99
Mark (L)	0~99
Input signal of NC side (F)	0~63 (byte)
Signal outputs to the NC side (G)	0~63 (byte)
I/O module (X)	0~63 (byte)
(Y)	0~47 (byte)

1.2 Concept of the Sequence Programming

The so-called sequence programming is the one that performing the logic control to the machine tool and its relative equipments.

After the programming is converted into some kind of format, CPU can be performed its code and calculation treatment for it, and its fruits can be memorized to RAM. CPU can be rapidly read each code stored in the memory, which can be performed the programming according to the calculation operation.

The compilation of the sequence programming starts with the ladder diagram.

1.3 Distribution Interface (Step one)

The interface can be distributed after confirming the control object and calculating the points of the corresponding input/output signal.

Refer to the Chapter Four Input/output interface signal table in the Volume Four *Installation and Connection* when distributing the interface.

1.4 Ladder Diagram Compilation (Step two)

The required control operation can be expressed by the ladder diagram with the on-line compilation of the Gsk218MC series ladder diagram. The functions, such as the timer and counter, can not be expressed by relay symbols, which can be indicated by the specified function code symbols.

The compiled ladder diagram should be stored and converted into the corresponding PLC codes before operating, namely, the so-called instruction list.

1.5 Sequence Programming Debugging (Step 3)

The sequence programming can be debugged using the following methods:

Debugging with emulator

The machine tool can be replaced by an emulator (it composes of the lights and switches). ON/OFF of the switch means the signal input state of the machine tool, and the ON/OFF of the light is the signal state output.

Debugging with actual operation

Debug on the actual machine tool. It is better to prepare the precautions before debugging, otherwise an unexpected behavior may occur.

CHAPTER TWO SEQUENCE PROGRAMMING

The operation principle is different with the common relay circuit, because the PLC sequence control is carried out by compiling the on-line diagram; and therefore, it is better to thoroughly comprehend the sequence control principle when designing the PLC sequence programming.

2.1 Performance Process of Sequence Programming

In the general relay controlling circuits, each of them can be simultaneously operated. When the relay A is operated in the following figure, the relay D and E can be operated (when the contactor A and B are entirely closed) at the same. Each relay in the PLC sequence control is operated in turn. The relay D is operated before relay A, and then the relay E operates (refer to the following figure). Namely, each relay is operated based upon the sequence of the ladder diagram (compilation sequence).

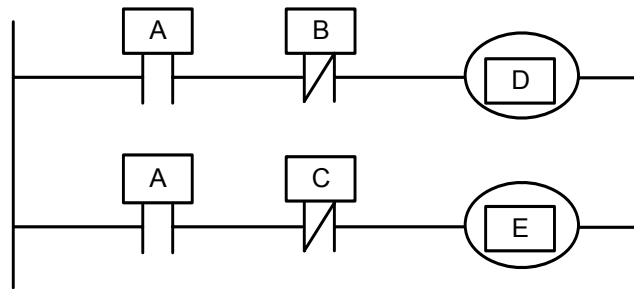

Fig. 2.1 (a) Circuit illustration

The differences between the relay circuit and PLC programming operation are shown below in the Fig. 2.1 (b) and Fig. 2.1 (c).

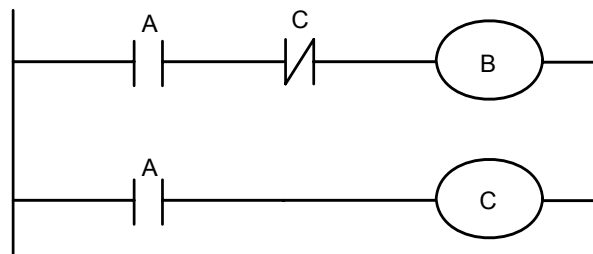

Fig. 2.1 (b)

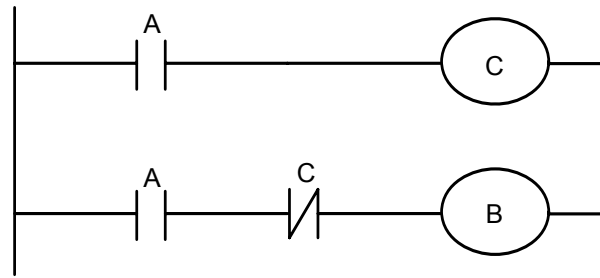

Fig. 2.1 (c)

(1) Relay circuit

Both Fig. 2.1 (b) and Fig. 2.1 (c) are shared a same operation. B and C are switched on after A is turned on. B is cut off after C is ON.

(2) PLC program

A same relay is shared a same circuit, refer to the Fig. 2.1 (b); B and C are switched on after A is turned on. B is cut off after one cycle of the PLC program is performed. In the Fig. 2.1 (c), C is ON instead of B, after C is turned on.

2.2 Cycle Performance

PLC performs from the beginning to the end of the ladder diagram. It performs again from the beginning of the ladder diagram after this diagram is performed, which is called cycle performance.

The performance time from the beginning to the end of the ladder diagram is abbreviated as a period of a cycle treatment. The shorter of the treatment period is, the stronger of the response capacity of the signal is.

2.3 Priority Sequence of the Execution (the 1st Level, the 2nd level)

GSK218MC Series PLC program are composed of two parts: the 1st level program and the 2nd level program, which are inconsistent with the performance period.

The 1st level program performs once each 8ms, which can be treated the short pulse signal required for fast response.

The 2nd program performs once each $8 \times n$ ms. N is the partition number of the 2nd level program. PLC may divide the 2nd level program into N parts when the 2nd level program is executed. It is performed one part for each 8ms.

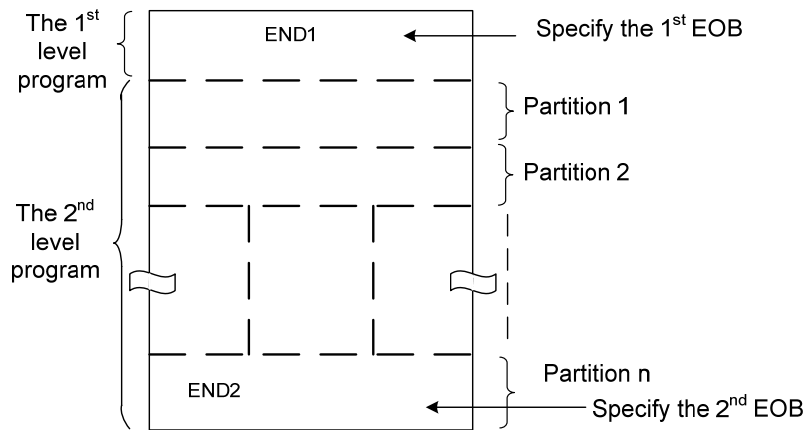

Fig. 2-3-1

PLC in the GSK218MC series is separately performed in the PLC-AVR SCM. The 1ms of each 8ms is the communication time for reading the PLC data from the CNC. The 5ms is that the PLC gains the system control signal (F, X), and uploads the control result data (G and Y parameters) external port I/O (X and Y). PLC is always performed the ladder diagram calculation other than the interruption of the response exchange data.

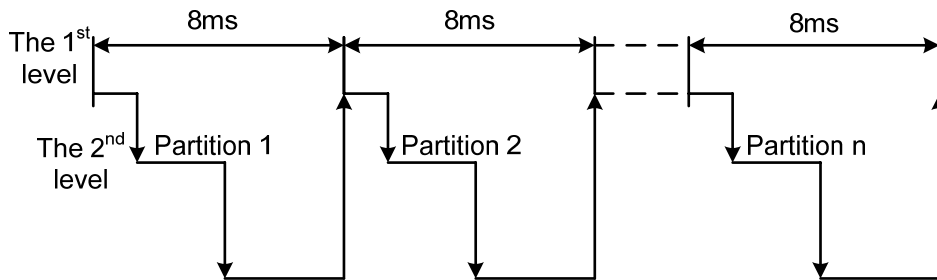

Fig. 2-3-2

When the last partition number of the 2nd level program of the n is performed, the program then executes from its beginning. In this case, when the partition number is n, the performance time of one cycle is 8*n ms. The 1st level program performs once each 8ms; the 2nd level program performs once each 8*n ms. If its steps of the 1st level program is increased, and therefore the steps of the 2nd level program within 8ms should be reduced correspondingly; the partition number may be increased, and the treatment time of the overall programs will be longer. So, the compilation of the 1st level program should be shorter.

2.4 Sequence Program Structure

The ladder diagram compiles in turn in the traditional PLC. However, it owns the following advantages in the ladder diagram language allowing the structured programming:

1. The program is easy to comprehend and compile.
2. It is more convenient to find the faults during the programming.

3. It is easy to find some reasons when the operation malfunction occurs.

There are 3-kind of structuring programming methods:

Sub-program

The subprogram is regarded as a treatment unit based on the ladder diagram.

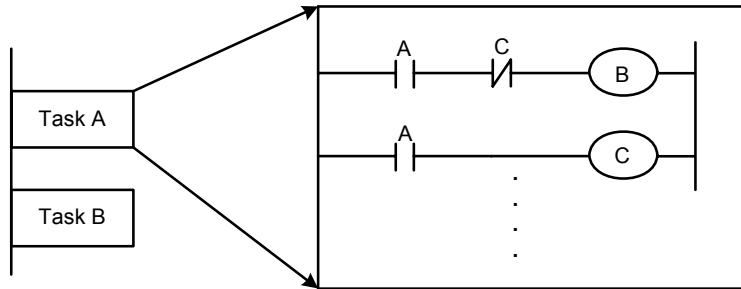

Fig. 2-4-1

Nesting

One subprogram can be performed the task by calling another one.

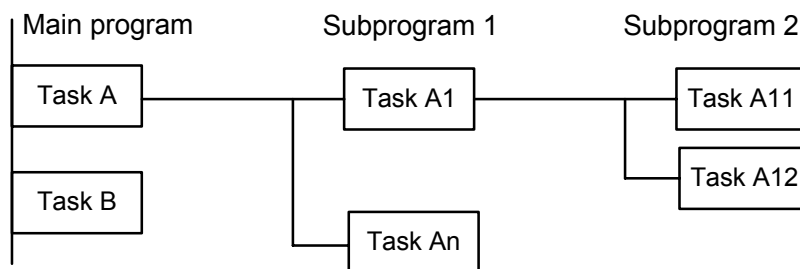

Fig. 2-4-2

Conditional branch

The main program is performed circularly, and checks whether its conditions are suitable. If does, perform the corresponding subprograms, vice versa.

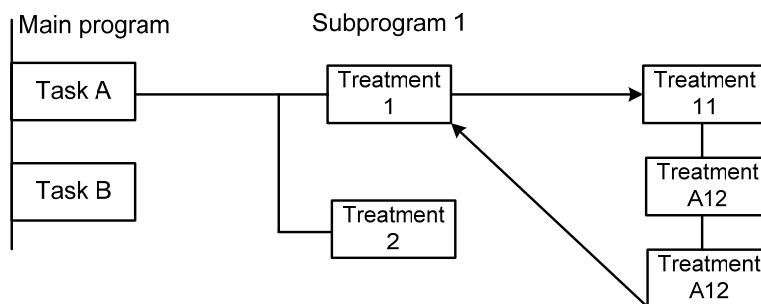

Fig. 2-4-3

2.5 Input/output Signal Treatment

Input signal treatment:

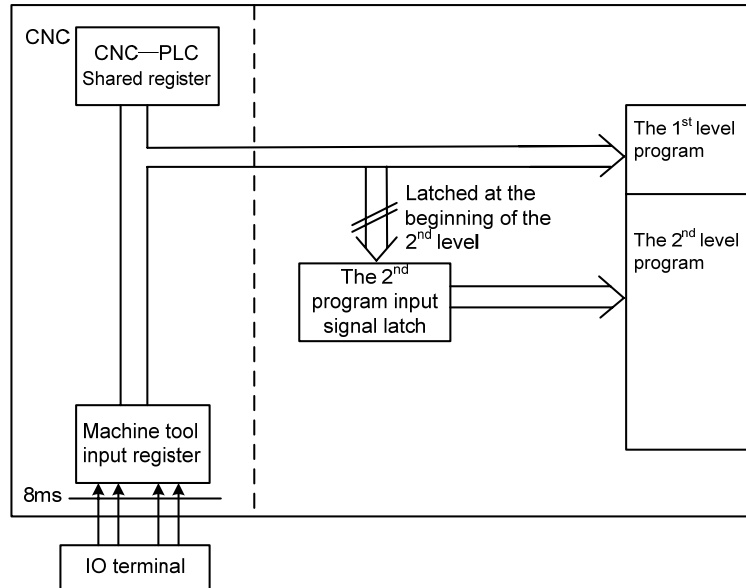

Fig. 2-5-1

Output signal treatment:

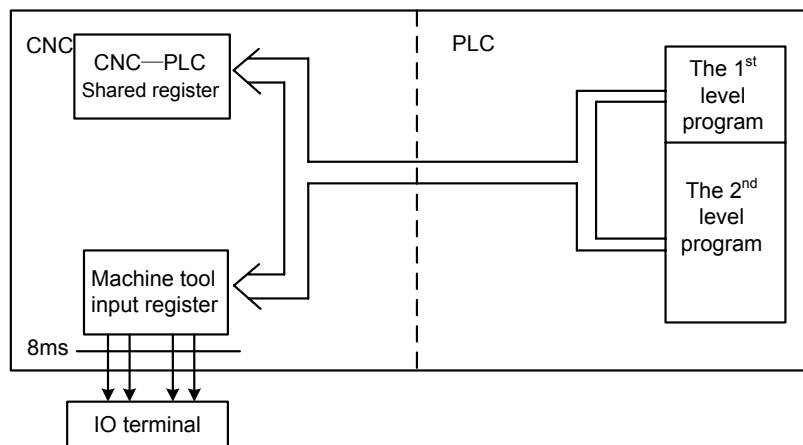

Fig. 2-5-2

2.5.1 Input Signal Treatment

(1) NC input register

The NC input signals from the NC are memorized into the NC input register, which are transferred to PLC each 8ms. The 1st level program performs the corresponding treatment using state of these signals.

(2) Machine tool input register

The machine tool input register is scanned and memorized its input signal from the machine each 8ms. The 1st level program is also performed the corresponding treatment by using this signals directly.

(3) The 2nd level program input latch

The 2nd level program input signal latch is also called the 2nd level program synchronic input signal register. Wherein, the stored input signal is treated by the 2nd level program. This signal state in the register is synchronic with the 2nd level one.

The signals both in the NC and machine tool input latch can be locked to the 2nd level program input latch, as long as the 2nd level program performs. The signal state in this latch keeps invariable during the performance of the 2nd level program.

2.5.2 Treatment of the Output Signal

(1) NC output register

The output signal transfers to the NC output register from the PLC each 8ms.

(2) Machine tool output register

The signal memorized in the machine tool output register conveys to the machine tool each 8ms.

Note: The signal states, such as the NC input register, NC output register, machine input register and machine output register, which can be displayed by the self-diagnosis function. The diagnosis number is the address number in the sequence programming.

2.5.3 Distinguish of Signal State Between 1st Level and 2nd Program

As for the same input signal, their states may different between the 1st and 2nd level programming, that is the reason that different registers are used between two levels programming. Namely, the input signal used with the 2nd level program is the one of the 1st level who is locked. And therefore, the signal in the 2nd level program is later than the 1st level one. At the worst case, one 2nd level program performance cycle can be lagged.

It is better to remember this point when programming the ladder diagram.

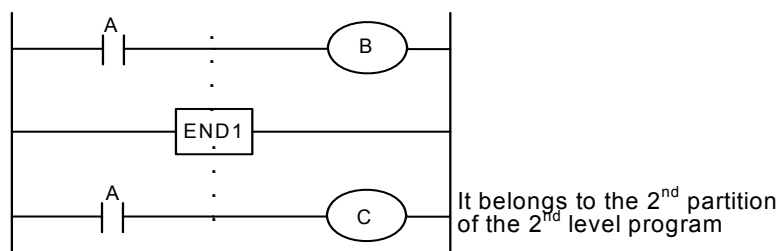

Fig. 2-5-3-1

A=1 performs the 1st level program when the 1st 8ms is performed, then B=1. And therefore, the 2nd level program is performed, the A=1 is latched to the 2nd level program, and then the first partition of the 2nd level program is completed.

A turns into 0 to perform the 1st level program when the 2nd 8ms is performed, then B=0. And therefore, the 2nd partition of the 2nd level program is performed; in this case, the state of the A is still latched as the one last time. So, C=1.

In this way, the state both B and C are different.

2.6 Interlocking

In the sequence control, the interlocking is very important from the safety issue.

It is necessary to use the interlocking in the sequence control programming. Simultaneously, the hard interlocking is used in the relay control circuit of the strong electric cabinet of the machine tool sides. This is the reason that the interlocking is disabled when the hardware of the performance sequence programming malfunctions, even if the interlocking is logically used in the sequence program (software). And therefore, the interlocking can be ensured the safety for the user, and prevent the machine tool from damaging in the strong electric cabinet of the machine sides.

CHAPTER THREE PLC ADDRESS

An address can be used for distinguishing a signal. Different address is separately corresponding to the I/O signal at the side of the machine tool, the I/O signal at the side of the CNC, the internal relay, the counter, the timer, the keep relay and the data list. Each address is composed of the address number and bit number, and its number is as shown below:

Address number rules:

Address number consists of Address Type, Address Number and Bit Number.

X 000 . 6

Type Address No. Bit No.

Address type: X, Y, R, F, G, K, A, D, C and T

Address number: Decimal number means one byte.

Bit number: Octonary number system, 0~7 are separately indicated the bytes (0~7 bits) in the front of the address number.

The address type of the GSK218MC PLC is shown below:

Table 3-1

Add.	Address explanation	Length
X	Machine → PLC (64 bytes)	INT8U
Y	PLC → machine tool (48 bytes)	INT8U
F	CNC → PLC (64 bytes)	INT8U
G	PLC → CNC (64 bytes)	INT8U
R	Intermediate relay (512 bytes)	INT8U
D	Data register (0~255)	INT16U
DC	The data register of the counter preset value	INT16U
C	Counter (0~127)	INT16U
A	PLC alarm detection	INT8U
T	Timer (0~127)	INT16U
DT	The data register of the timer preset value	INT16U
K	Keep relay (64 types)	INT8U

INT8U data type is 8-bit character type without symbol, INT16U data type is 16-bit integral type without symbol.

3.1 Machine → PLC address (X)

The X address of the GSK218MC PLC composes of two types:

1. The X address is assorted with the three I/O input terminals, namely, XS40, XS41 and XS42.
2. The X address is assorted with the input button on the MDI panel of the system.

3.1.1 X Address on I/O Input

The addresses (48 addresses) are defined as INT8U from X0 to X5, which are distributed on the three I/O input terminals, for example, XS40, XS41 and XS42.

Users can define the signal significance of the X address of the I/O ports based upon the actual cases, which can be connected the machine tool and compiled the corresponding ladder diagram. Refer to the appendix one (GSK218MC CNC system PLC I/O address) and the configuration and definition of the internal software components for the initial definition of the input address.

3.1.2 X Address on MDI Panel

There are 11 types from the addresses X20 ~ X30 of which these addresses are corresponding with the button input on the MDI panel one by one. User can not modify its signal definition. The buttons on the MDI panel should be firstly responded by CNC, and then conveys the X signal to PLC.

The corresponding relationships are shown below:

Table 3-1-2-1

Operation panel key input	PLC add.	Operation panel key input	PLC add.
Edith method	X20.0	Rapid switch	X24.7
Auto method	X20.1	F0/ 0.001	X26.0
MDI method	X20.2	F25%/ 0.01 (218MC-U1is the rapid override addition)	X26.1
Zero return method	X20.3	F50%/ 0.1 (218MC-U1is the rapid override 100%)	X26.2
Single step method	X20.4	F100%/ 1 (218MC-U1is the rapid override reduction)	X26.3
Manual method	X20.5	Manual feed axis +1st	X27.0
MPG method	X20.6	Manual feed axis +2nd	X27.1
DNC method	X20.7	Manual feed axis +3rd	X27.2
Skip	X21.0	Manual feed axis +Nth	X27.3
Single block	X21.1	N axis +(+ spindle	X27.4

Operation panel key input	PLC add.	Operation panel key input	PLC add.
		override 218MC integration)	
Dry run	X21.2	Manual feed axis -1st	X28.0
Miscellaneous lock	X21.3	Manual feed axis -2nd	X28.1
Machine lock	X21.4	Manual feed axis -3rd	X28.2
Optional stop	X21.5	Manual feed axis -Nth	X28.3
Program restart	X21.6	N axis- (- spindle override 218MC integration)	X28.4
Working indicator	X21.7	Spindle orientation	X29.0
Spindle positive	X22.0	Tool magazine zero return	X29.1
Spindle stop	X22.1	Tool clamping/tool releasing	X29.2
Spindle negative	X22.2	Tool magazine positive	X29.3
Spindle JOG	X22.6	Tool magazine negative	X29.4
Channel selection (218MC-H/-V)	X22.7	Tool-pivoting (Tool-infeed)	X29.5
Lubrication	X23.0	Tool return (Tool-retraction)	X29.6
Cooling	X23.1	Tool-change hand	X29.7
Chip-removal	X23.2	Overtravel releasing	X30.0
ESP	X23.5	- spindle override (218MC-H/-V is the spindle override SOV1)	X31.0
Cycle start	X23.6	Spindle override cancellation (218MC-H/-V is the spindle override SOV2)	X31.1
Feed hold	X23.7	+ spindle override (218MC-H/-V is the spindle override SOV4)	X31.2
User 1 (218MC-U1 is the blank button)	X24.0	- feed override (218MC-H/-V is the feedrate FOV1)	X31.3
User 2	X24.1	Feedrate cancellation (218MC-H/-V is the feedrate FOV2)	X31.4
User 3	X24.2	+ feedrate (218MC-H/-V is the feedrate FOV4)	X31.5
User 4	X24.3	Feedrate FOV8 (218MC-H/-V)	X31.6

Operation panel key input	PLC add.	Operation panel key input	PLC add.
User 5	X24.4	Feedrate FOV16 (218MC-H/-V)	X31.7

3.2 PLC → Address of Machine Tool Side (Y)

The Y address of the GSK218MC PLC composes of two types:

1. The Y address is assorted with the three I/O input terminals, namely, XS43, XS44 and XS45.
2. The Y address is assorted with the indicator on the MDI panel of the system.

3.2.1 Y Address on I/O Output Port

The addresses (48 addresses) are defined as INT8U from Y0 to Y5, which are distributed on the three I/O input terminals, for example, XS43, XS44 and XS45.

Users can define the signal significance of the Y address of the I/O ports based upon the actual cases, which can be connected the machine tool and compiled the corresponding ladder diagram. Refer to the appendix one (GSK218MC CNC system PLC I/O address) and the configuration and definition of the internal software components for the initial definition of the input address.

3.2.2 Y Address on MDI Panel

There are 8 types from the addresses Y12 ~ Y19 of which these addresses are corresponding with the button input on the MDI panel one by one. User can not modify its signal definition. PLC system reports to the CNC system keyboard module after calculating, and it is used for displaying the indicator signal.

The corresponding relationships of each prompt indicator:

Table 3-2-2-1

Keyboard indicator output	PLC add.	Keyboard indicator output	PLC add.
Edit button indicator	Y12.0	Spindle orientation indicator	Y15.7
Auto button indicator	Y12.1	Tool magazine zero return indicator	Y16.0
MDI button indicator	Y12.2	+ Tool magazine indicator	Y16.1
Zero return button indicator	Y12.3	- Tool magazine indicator	Y16.2
Single-step button indicator	Y12.4	Tool magazine infeed indicator	Y16.3
Manual button indicator	Y12.5	Tool magazine retraction indicator	Y16.4
MPG button indicator	Y12.6	Tool magazine releasing/clamping	Y16.5

Keyboard indicator output	PLC add.	Keyboard indicator output	PLC add.
		indicator (218MC-U1 is RUN indicator)	
DNC button indicator	Y12.7	Tool magazine tool-change hand indicator (218MC-U1 is READY indicator)	Y16.6
Spindle CCW indicator	Y13.0	USER3 indicator (218MC-U1 is ALM indicator)	Y16.7
Spindle CW indicator	Y13.1	+ the 1 st axis button indicator	Y17.0
Spindle stop indicator	Y13.2	+ the 2 nd axis button indicator	Y17.1
The 1 st axis zero return indicator	Y13.3	+ the 3 rd axis button indicator	Y17.2
The 2 nd axis zero return indicator	Y13.4	+ the 4 th axis button indicator	Y17.3
The 3 rd axis zero return indicator	Y13.5	USER1 button indicator	Y17.4
The 4 th axis zero return indicator (218MC); The 4 th and the 5 th axis zero turn indicator (218MC-H/-V)	Y13.6	N axis series sequence addition button indicator	Y17.5
The 5 th axis zero return indicator (218MC)	Y13.7	USER4 button indicator	Y17.6
Skip indicator	Y14.0	USER5 button indicator (218MC-U1 is spindle override cancel (100%) indicator)	Y17.7
Single block indicator	Y14.1	- the 1 st axis button indicator	Y18.0
Dry run indicator	Y14.2	- the 2 nd axis button indicator	Y18.1
Miscellaneous lock indicator	Y14.3	- the 3 rd axis button indicator	Y18.2
Machine locking indicator	Y14.4	- the 4 th axis button indicator	Y18.3
Machine illumination indicator	Y14.5	USER2 button indicator	Y18.4
Lubrication indicator	Y14.6	N axis series sequence reduction button indicator	Y18.5
Cooling indicator	Y14.7	Channel selection button indicator	Y18.6
Chip-removal indicator	Y15.0	JOG button indicator	Y18.7
Feedrate cancel button indicator	Y15.1	Overtravel end button indicator	Y19.0
Rapid switch indicator	Y15.2	Feed dwell button indicator	Y19.1
0.001/F0 button indicator	Y15.3	Cycle start button indicator	Y19.2
0.01/25% button indicator	Y15.4	Tool magazine zero indicator (218MC integration)	Y19.3
0.1/50% indicator (218MC-U1 is rapid override 100% indicator)	Y15.5	Optional stop indicator	Y19.4
1/100% button indicator	Y15.6	Program restart indicator	Y19.5

3.3 PLC →CNC Address (G)

The addresses from G0 to G63, its definition type: INT8U, 64 bytes in total.

The operation panel key signal is shown below:

Table 3-3-1

Operation panel button signal	PLC add.	Operation panel button signal	PLC add.
Edit method	G20.0	Rapid Fo	G25.0
Auto method	G20.1	Rapid 25%	G25.1
MDI method	G20.2	Rapid 50%	G25.2
Zero return method	G20.3	Rapid 100%	G25.3
Single step method	G20.4	Incremental step length 0.001	G26.0
Manual method	G20.5	Incremental step length 0.01	G26.1
MPG method	G20.6	Incremental step length 0.1	G26.2
DNC method	G20.7	Incremental step length 1	G26.3
SKIP	G21.0	MPG one block to shift 0.001	G26.4
Single block	G21.1	MPG one block to shift 0.01	G26.5
Dry run	G21.2	MPG one block to shift 0.1	G26.6
Miscellaneous lock	G21.3	Manual feed axis +1 st	G27.0
Machine lock	G21.4	Manual feed axis +2 nd	G27.1
Optional stop	G21.5	Manual feed axis +3 rd	G27.2
Program restart	G21.6	Manual feed axis +4 th	G27.3
Spindle CCW (Positive)	G22.0	Manual feed axis -1 st	G28.0
Spindle stop	G22.1	Manual feed axis -2 nd	G28.1
Spindle CW (Negative)	G22.2	Manual feed axis -3 rd	G28.2
Spindle override cancel (218MC)	G22.4	Manual feed axis -N th	G28.3
Spindle JOG	G22.6	Spindle orientation	G29.0
Channel selection signal	G22.7	Tool magazine zero return	G29.1
Lubrication	G23.0	Tool clamping/releasing	G29.2
Cooling	G23.1	+ tool magazine	G29.3
Chip-removal	G23.2	- tool magazine	G29.4
Cycle start	G23.6	Tool magazine pivoting	G29.5
Feed hold	G23.7	tool magazine retraction	G29.6
Feedrate cancel (218MC)	G24.1	Tool-change hand	G29.7
Rapid switch	G24.7	Overtravel releasing	G30.0

The signal of G63 bytes are used inside the system, the G63.0, G63.1 and G63.2 are the answer signal inside the system separately performed by M, S and T.

3.4 CNC →PLC Address (F)

The addresses from F0 to F63 are defined as: INT8U, 64 bytes in total.
Refer to the Chapter Two Function for details.

3.5 Internal Replay Address (R)

The address area is reset when the system is turned on. R510 and R511 are used by the system.

Its definition type is: INT8U, 512 bytes in total.

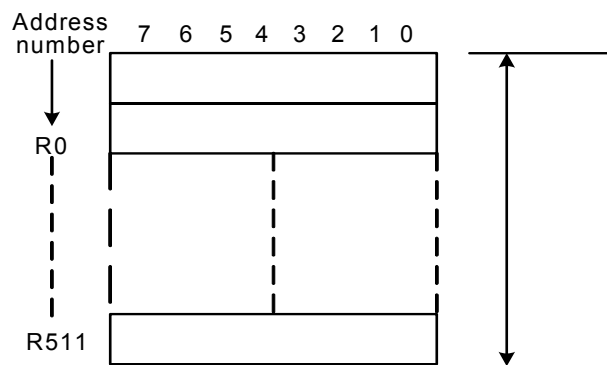

Fig. 3-5-1

System program administration area

R510

The signal of R510.0 address is set to 1 when PLC starts and restarts, which is used the signal set by the initial user. The R510.0 is reset to 0 after the ladder diagram is performed once.

R511 (System timer)

The following four signals can be used for system timer:

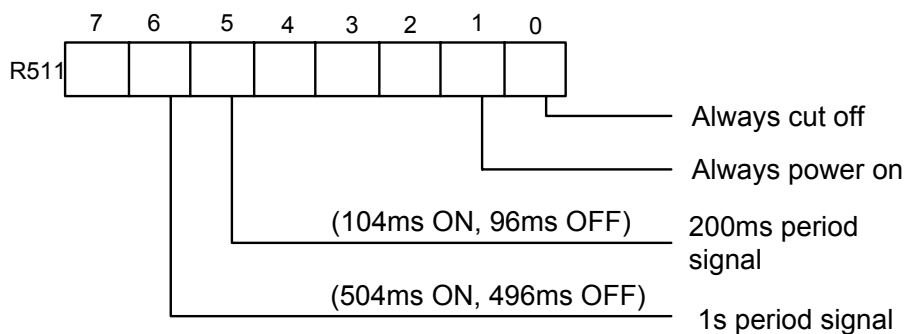

Fig. 3-5-2

3.6 Nonvolatile Relay Address (K)

This address area is used for nonvolatile replay and PLC parameter setting. This area is called nonvolatile relay area, namely, the content inside the register will not lose even if the system is turned off. K000~K005 are used by the system, which is used to protect the PLC system parameter, it is very convenient for user to control PLC in the CNC system.

Its definition type: INT8U, 64 bytes in total.

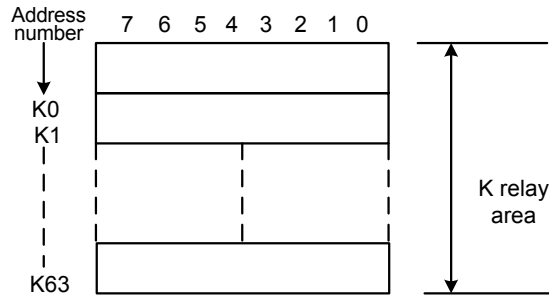

Fig. 3-6-1

Note: When PLC address K005.2 =1, PLC enters the debugging mode. All of the external alarms are cancelled, and the machine interlocking signals are then cancelled, the tool-change code can not be performed. The parameter can be modified only when comprehending the parameter, so that the damage in the machine tool or injury of the person may occur.

3.7 Information Display Request Address (A)

This address area is cleared when the system is turned on.

Its definition type: INT8U, 32 bytes in total.

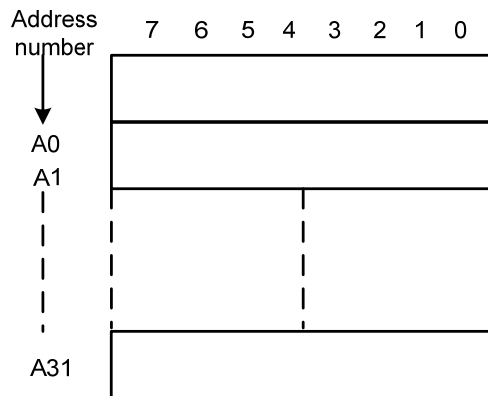

Fig. 3-7-1

3.8 Counter Address (C)

This area is used for placing the current counting value of the counter. The data is cleared after the system is turned off.

Its definition type: 128 addresses in total.

3.9 Counter Preset Value Address (DC)

This address area is used for storing the counter preset, which is a nonvolatile storage area, that is, the memorized content may not loose even the system is power off.

Its definition type: 128 addresses in total. The setting value of the DC is only read instead of writing.

3.10 Timer Address (T)

This address area is used for storing the current numerical value of the timer. The data initial is presetting value after the system is power off. Current data is presetting value when it is set to 0.

Its definition type: 128 addresses in total.

3.11 Presetting Value Address of Timer (DT)

This address area is used for placing the timer preset value. This area is nonvolatile register area, namely, the content inside the register will not lose even if the power of the system is turned off.

Its definition type: 128 addresses. The setting value of the DT is only read instead of writing.

3.12 Data Table Address (D)

The content inside the memory will not lose even if the power of the system is turned off.

Its definition type: 256 addresses in total. Wherein, D240~247 are used by the system, users can not define by themselves.

3.13 Address Mark (L)

It is used to specify signs both skip object and the LBL code marks in the JMPB code.

Its range: 0~99

3.14 Subprogram Number (P)

It is used to specify the called object subprogram number in the CALL code and the subprogram number in the SP code.

Its range: 0~99

CHAPTER FOUR PLC BASIS CODE

The design of the sequence program begins from compiling ladder diagram. The ladder diagram consists of relay contact and function code. The logic relationship in the ladder diagram composes of sequence program. There are two methods of the sequence program input: one uses the mnemonic symbol language (The system is not temporarily supported the PLC command code of the RD, AND and OR); the other one is used the relay symbol. The programming can be compiled using ladder diagram instead of comprehending the PLC code based upon the latter.

Actually, the sequence program inside the system can be converted into corresponding PLC code even if it is input by the relay symbol.

The basis codes are commonly used one when designing the sequence programming, which are performed one-digit calculation.

The basis command codes of the GSK218MC series are shown below:

Table 4-1

Code name	Function
RD	Left shift 1-bit of the register's content, the signal state specified by address is set to ST0
RD.NOT	Left shift 1-bit of the register's content, the signal state specified by address is set to ST0 after its state is set to NOT.
WRT	Output the logic calculation result to the specified address
WRT.NOT	Output the logic calculation result after NOT to the specified address.
AND	Logic AND
AND.NOT	Logic AND after the specified state is set to NOT.
OR	Logic OR
OR.NOT	Logic OR after the specified state is set to NOT.
OR. STK	Right shift 1-bit of the stacked register after ST0 and ST1 logic OR
AND.STK	Right shift 1-bit of the stacked register after ST0 and ST1 logic AND

4.1 RD, RD.NOT, WRT, and WRT.NOT Codes

Mnemonic symbol and function

Table 4-1-1

Mnemonic symbol	Function
RD	Left shift 1-bit of the register' content, the signal state specified by address is set to ST0.

RD.NOT	Left shift 1-bit of the register' content, the signal state specified by address is set to ST0 after it is set to NOT.
WRT	Output the logic calculation result to the specified address
WRT.NOT	Output the logic calculation result after NOT to the specified address

Code explanation

- WRT and WRT.NOT codes are the coil drive code of the output relay and internal relay, but the input relay can not be used.
- The parallel WRT command can be used multiply, but it can not output with double coil.

For example

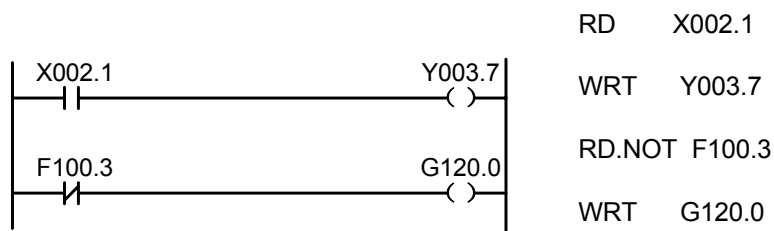

Fig. 4-1-1

4.2 AND, AND.NOT Codes

Mnemonic symbol and function

Table 4-2-1

Mnemonic symbol	Function
AND	Logic AND
AND.NOT	Logic AND after the specified state is NOT

Code explanation

- Connect 1 contact with series connection by using AND, AND.NOT code. The numbers of series connection contacts are unconstrained, and this code can be used for dozens of times.

For example:

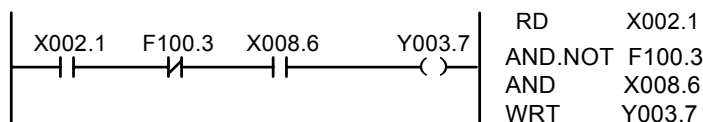

Fig. 4-2-1

4.3 OR, OR.NOT Codes

Mnemonic symbol and function

Table 4-3-1

Mnemonic symbol	Function
OR	Logic OR
OR.NOT	Logic OR after the specified state is NOT

Code explanation

- Connect 1 contact with series connection using the OR and OR.NOT code.
- OR, OR.NOT is started from the step of this code; it can be connected with series connection with the abovementioned RD, RD.NOT code step.

For example:

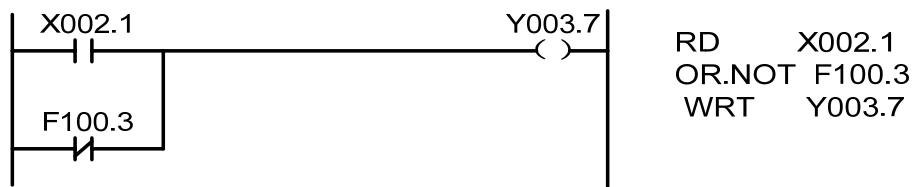

Fig. 4-3-1

4.4 OR. STK Code

Mnemonic symbol and function

Table 4-4-1

Mnemonic symbol	Function
OR. STK	Right shift 1-bit of the stacked register after ST0 and ST1 logic OR

Code explanation

- OR.STK code is the separate code without any address.

For example:

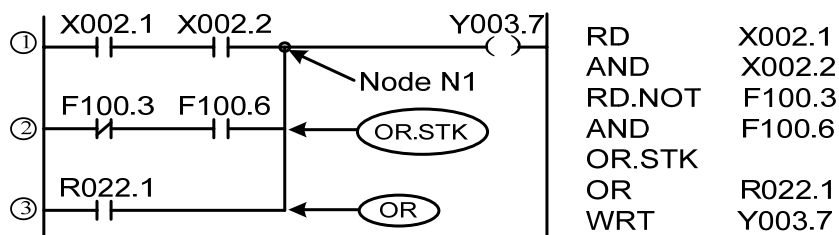

Fig. 4-4-1

There are three branches ①, ② and ③ from the left bus to the node N1. The branches ① and ② are series connection circuit block. When the series connection circuit block is performed between bus to node or among the nodes, other than the 1st branch, use the RD code when the following branch is ended. The branch ③ is not a series connection circuit block, which can be used by the OR code.

OR. STK and AND. STK are the codes without operation component, which are indicated the OR , AND relationships between circuit blocks.

4.5 AND. STK Code

Mnemonic symbol and function

Table 4-5-1

Mnemonic symbol	Function
AND.STK	Right shift 1-bit of the stacked register after ST0 and ST1 logic AND

Code explanation

- Use the AND. STK coded when the branch circuit (parallel circuit block) is connected with series connection with the front of the circuit. The branch start is used RD, RD.NOT codes. Use the AND. STK code connecting with series connection with the front of the circuit after the series connection circuit block is executed.
- AND. STK code is the separate code without any address.

For example:

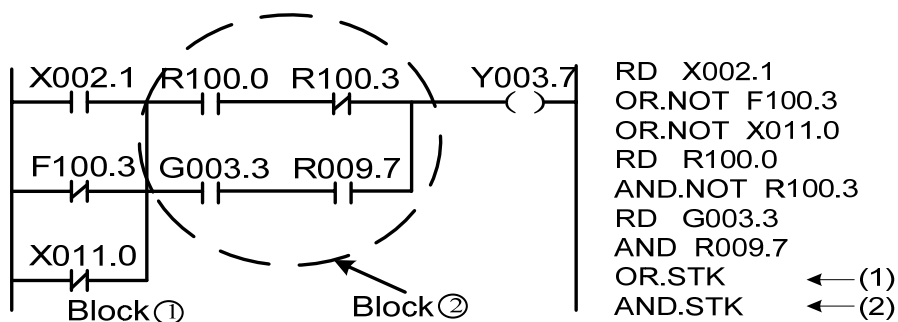

Fig. 4-5-1

As for the abovementioned ladder diagram and command table, (1)OR.STK indicates parallel connection in the series connection circuit block in the block ②, (2)AND.STK expresses the series connection between circuit block ① and ②.

CHAPTER FIVE PLC FUNCTION CODE

It is hard to compile some machine operations using the basis command codes, but the function command codes can be simplified it.

Table 5-1 (218MC series PLC function command code)

Series No.	Name	Function	Series No.	Name	Function
1	END1	The 1 st level sequence program end	19	ROT	Binary rotation control
2	END2	The 2 nd level sequence program end	20	SFT	Register shift
3	CALL	Call subprogram	21	DIFU	Rising edge detection
4	CALLU	Unconditionally call the subprogram	22	DIFD	Trailing edge detection
5	SP	Subprogram	23	COMP	Binary number comparison
6	SPE	End of subprogram	24	COIN	Consistency comparison
7	SET	Setting	25	MOVN	Data transfer
8	RST	Resetting	26	MOVB	Transfer of one byte
9	JMPB	Sign skip	27	MOVW	Transfer of two bytes
10	LBL	Sign	28	XMOV	Binary indexed data transfer
11	TMR	Timer	29	DSCH	Binary data search
12	TMRB	Regular timer	30	ADD	Binary addition
13	TMRC	Timer	31	SUB	Binary subtraction
14	CTR	Binary counter	32	ANDF	Logic AND
15	DEC	Binary decode	33	ORF	Logic OR
16	COD	Binary code conversion	34	NOT	Logic NOT
17	COM	Control of the concentric line	35	EOR	Exclusive OR/ XOR
18	COME	End of the concentric line control			

5.1 END1 (The 1st Level Sequence Program End)

Function:

This function can be specified once in sequence program at the end of the 1st level program, or it can be performed at the beginning of the 2nd level program when the 1st level program does not execute. The first program can be compiled up to 500 steps.

Format:

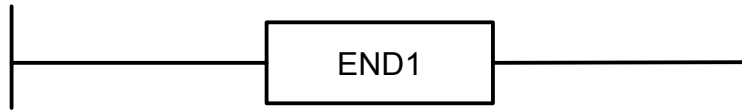

Fig. 5-1-1

5.2 END2 (The 2nd Sequence Program End)

Function:

It specifies at the end of the 2nd level program.

Format:

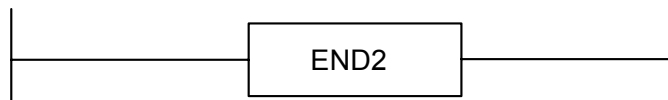

Fig. 5-2-1

5.3 CALL (Call Subprogram)

Function:

Call one specified subprogram

It owns the following characters and limitations:

Subprogram can be nested and called other subprograms up to 18 layers, as for the endless repetition caused by the closure call, the system may alarm. The system allows that the maximum subprogram call number is 100 for controlling the performance data value. The subprogram call can not be performed at the 1st level program. The code or network wrote between END2 AND SP, or after SPE, or before SP, the system can not be performed, and then alarms.

Format:

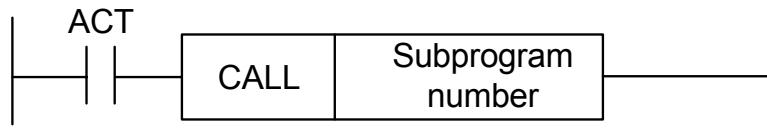

Fig. 5-3-1

Control condition:

ACT=0, Perform next code followed with CALL.

ACT=1, call subprogram of the specified subprogram number

Parameter:

Subprogram number: Specify the called subprogram number. The subprogram number is indicated at 0~99.

5.4 CALLU (Unconditionally Call Subprogram)

Function:

Unconditionally call one specified subprogram

It owns the following characters and limitations:

Subprogram can be nested and called other subprograms up to 18 layers, as for the endless repetition caused by the closure call, the system may alarm. The system allows that the maximum subprogram call number is 100 for controlling the performance data value. The subprogram call can not be performed at the 1st level program. The code or network wrote between END2 AND SP, or after SPE, or before SP, the system can not be performed, and then alarms.

Format:

Fig. 5-4-1

Parameter:

Subprogram serial number: Specify the called subprogram number, and its range is 0~99.

5.5 SP (Subprogram)

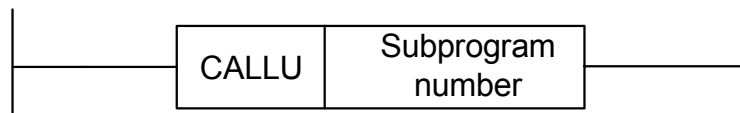
Function:

SP is used to generate a subprogram. The subprogram number is regarded as its name. The range of the subprogram is specified by the SP code and the after-mentioned SPE code together.

Notice:

1. The subprogram should be compiled followed END2.
2. Another subprogram can not be set inside one subprogram.

Format:

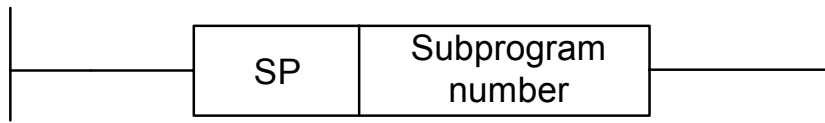

Fig. 5-5-1

Parameter:

Subprogram number: specify a called subprogram mark number, its range is 0~99.

5.6 SPE (End of Subprogram)

Function:

- * Use SPE and SP together to specify the range of subprogram.
- * The control will return to the main program of the called subprogram when this function code is performed.
- * The subprogram should be compiled after END2.

Figure format

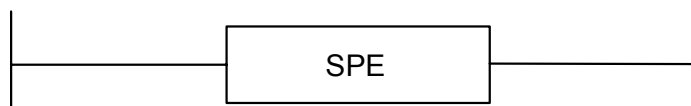

Fig. 5-6-1

For example

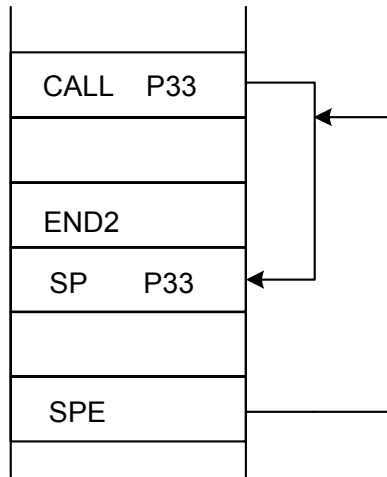

Fig. 5-6-2

5.7 SET (Replacement/Setting)

Function:

Set 1 in the specified address.

Format:

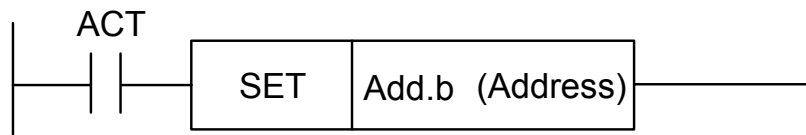

Fig. 5-7-1

Controllable condition:

ACT=0, the state of the add.b remains invariable.

ACT=1, the add.b is set to 1.

Parameter:

Add.b: setting component address bit can be treated as the output coil, Add = Y, G, R, K and A.

5.8 RST (Resetting)

Function:

Set 0 on the specifying place.

Format:

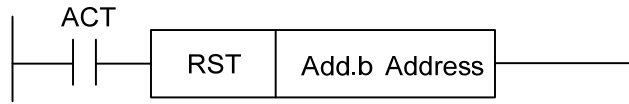

Fig. 5-8-1

Controllable condition:

ACT=0, the state of the add.b remains invariable.

ACT=1, add.b is set to 0.

Parameter:

Add.b: resetting component address can be treated as output coil, Add = Y, G, R, K and A.

5.9 JMPB (Mark Number Skip)

Function:

JMPB immediately transfers the control to program following with mark number in the ladder diagram programming.

The characters and limitations are shown below:

- * Multiple skip codes can be shared with the same mark number.
- * The skip can not be performed each other between the 1st and the 2nd level programs.
- * The skip can not be performed among the subprograms.
- * Rebound is allowable, but users should hold the endless cycle which may be caused by it.
- * The skip can not be performed between main program and subprogram.

Format:

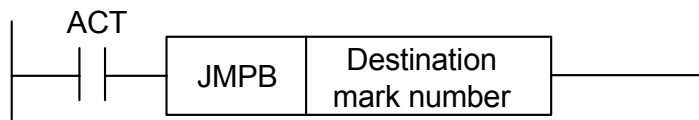

Fig. 5-9-1

Controllable condition:

ACT=0, Do not skip, perform the next code followed JMPB.

ACT=1, Perform the next code after the mark number when the skip jumps to the specified mark number.

Parameter

Lx: Specify a skip object mark number. Any value (from 0 to 99) can be specified.

5.10 LBL (Mark Number)

Function:

Specify one mark number in the ladder diagram, namely, it is a specified skip destination for JMPB.

It is very important to notice that one mark number with xx only can be specified once using LBL. It may alarm if it uses repeatedly.

Format:

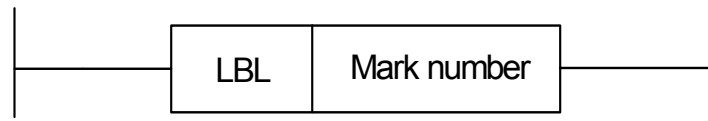

Fig. 5-10-1

Parameter:

xx: Specify a skip object mark number, its range is 0~99.

For example:

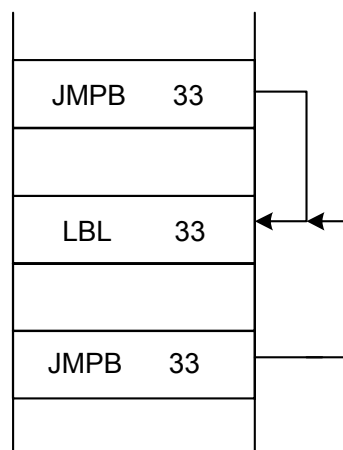

Fig. 5-10-2

5.11 TMR (Timer)

Function:

Delay conducting timer.

Format:

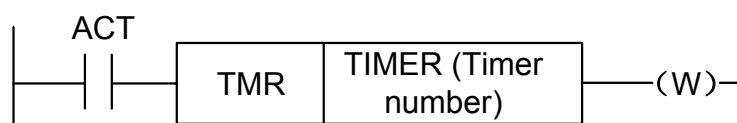

Fig. 5-11-1

Controllable condition:

ACT=0, close the timer.

ACT=1, start the timer.

The concrete operation is as follows:

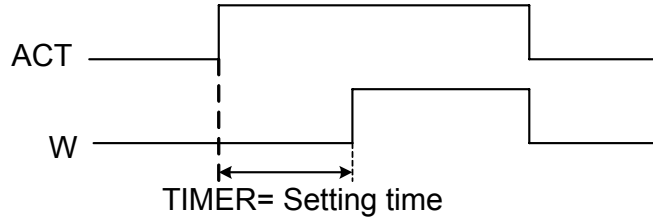

Fig. 5-11-2

Parameter:

TIMER : The timer number indicates by xxx (it expresses by numbers from 0 to 127).

Output:

W : Output coil. W=1 when it reaches to the resetting value, W=0 means it does not reach to it.

Note: TIMER performs once each 8ms, its setting unit is ms, and 8ms is the performance radix, complete 8ms if it is insufficient. For example: the setting is 54ms, $54=6*8+6$, complete 2ms, the actual performance is 56ms. The time of the timer is set in the [TMR] of the [PLCPAR] under the program-controlled interface. The sequence number of the timer may be detected its range by the system directly. The alarm may occur when the sequence number repeats or exceeds its range.

5.12 TMRB (Fixed Timer)

Function:

Delay conducting timer

Format:

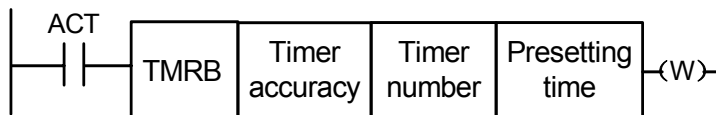

Fig. 5-12-1

Controllable condition:

ACT=0, Close the timer

ACT=1, Start the timer

The concrete operation is as follows:

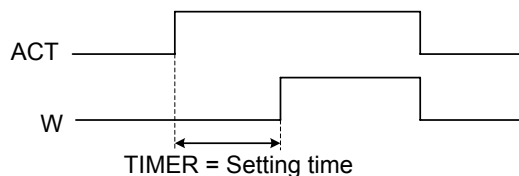

Fig. 5-12-2

Parameter:

TIMER: Fix the timer number, it indicates by xxx, xxx is numbers from 0 to 127.

Table 5-12-1 (Timer accuracy)

Timer accuracy	Setting No.	Timer range setting	Error range
8ms	0	From 8ms to 524.280s	Scan period from 0 to the 1 st level program
48ms	1	From 48ms to 31.456min	Scan period from 0 to the 1 st level program
1s	2	From 1s to 546 min	Scan period from 0 to the 1 st level program
10s	3	From 10s to 182 h	Scan period from 0 to the 1 st level program
1min	4	From 1min to 65535min	From 0 to 1s
1ms	5	From 1ms to 65.4s	Scan period from 0 to the 1 st level program

Presetting time

The time setting of the fixed timer, its numerical range is: 0~65535.

Output

W : Coil output. W=1, it reaches to the presetting. W=0, it does not reach.

Note: As for the sequence of the timer, the system may check its range automatically, if the repeated sequence or out of the range, the system may alarm. The presetting time in timer is solidified in the ROM along with the ladder diagram, so, the time of the timer only can be changed by modifying the ladder diagram file.

5.13 TMRC (TIMER)

Function

Delay conducting timer

Format

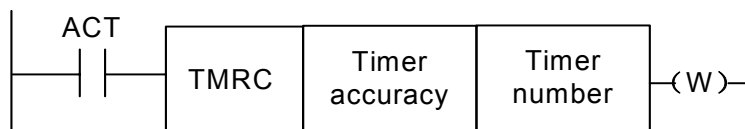

Fig. 5-13-1

Controllable condition

ACT=0, Close the timer

ACT=1, Start the timer

The concrete operation is as follows:

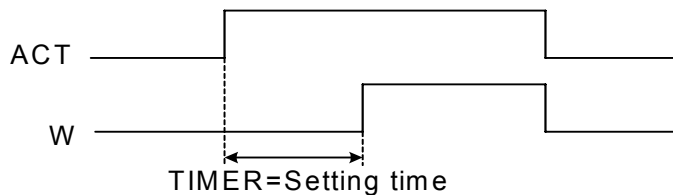

Fig. 5-13-2

Parameter

TIMER: The timer number indicates by xxx (xxx expresses by numbers from 0 to 127).

Table 5-12-1 (Timer accuracy)

Timer precision	Setting No.	Setting time range	Error range
8ms	0	From 8ms to 524.280s	Scan period from 0 to the 1 st level program
48ms	1	From 48ms to 31.456 min	Scan period from 0 to the 1 st level program
1s	2	From 1s to 546 min	Scan period from 0 to the 1 st level program
10s	3	From 10s to 182 h	Scan period from 0 to the 1 st level program
1min	4	From 1min to 65535min	From 0 to 1s
1ms	5	From 1ms to 65.4s	Scan period from 0 to the 1 st level program

Output:

W : Output coil. W=1, it reaches to the presetting, W=0, it does not reach to it.

Note: The time of the timer is set in the [TMR] in the [PLCPAR] controlling by the program control surface. TMRC and TMR timers are shared with a same address, so, the TMRC and TMR timers can not be repeatedly used. The system may automatically check the range of the timer sequence. It may alarm when the sequence number is repeated or exceeded its range.

5.14 CTR (Binary Counter)

Function:

The data in the counter are binary system, which have the following functions based upon the applications.

- 1) Presetting counter

If the count reaches to the output signal of presetting value, preset the numerical value.

- 2) Ring-counter

When the counter reaches to the presetting value, it inputs the count signal and resets the initial value and performs the count again.

3) Addition and subtraction counter

This is treated as the forward-backward counter, which can be used both addition and subtraction.

4) The selection of the initial value

The initial value can be regarded as 0 or 1.

Format:

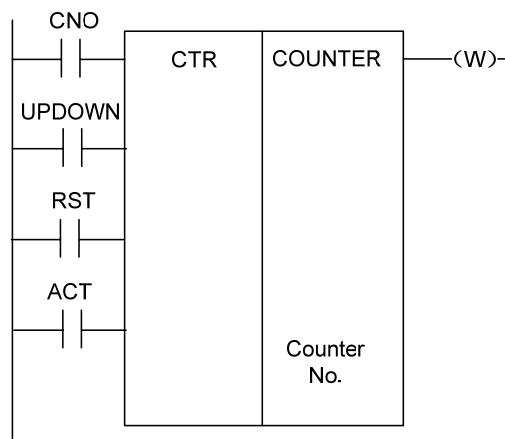

Fig. 5-14-1

Controllable condition:

Specify initial value (CN0):

CN0=0, counter begins with 0.

CN0=1, counter begins with 1.

Specify rising or descending counter (UPDOWN):

UPDOWN=1, subtraction counter

UPDOWN=0, addition counter

Reset (RST):

RST=0, Remove the reset

RST=1, reset: W resets to 0, and the counter value reset to initial value. The RST is set to 1, as long as the reset is required.

Counting signal (ACT):

ACT=1: Count performs when ACT is at the rising edge.

ACT=0: Counter does not operate, W holds unchangeable.

Parameter:

COUNTER: Specify the number of the counter, which is indicated by xxx (xxx is No. 0 to No.127).

Output:

W : Coil output, W=1, it reaches to the presetting value.

Note 1: The system may automatically check the sequence number range of the timer, it may alarm if the sequence

is repeated or exceeded its range.

Note 2: The current value of the timer may automatically clear, after the ladder diagram is converted and downloaded.

Reset the counter by the pulse signal before counting for ensuring the reliable of the counter.

5.15 DEC (Binary Decoding)

Function:

DEC can be decoded for the binary system code data, one of the consecutive data of the specified 8-bit (1 type) or 16-bit (2 types) is same as the code data. The corresponding output data bit is 1; the output data is 0 without any same number.

This code is used for the data decode of M or T function.

Format:

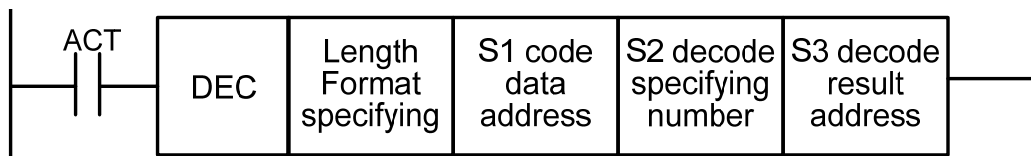

Fig. 5-15-1

Controllable condition:

ACT=0: Reset all of the output bits.

ACT=1: Perform the data decode; the treated result is set at the output data address.

Parameter:

Length: Set the dimension of the code data at the 1st bit data of the parameter.

0001: The code data is binary system code data of one byte.

0002: The code data is binary system code data of two bytes.

S1: Code data address. Specify an address of the storage code data.

S2: Decoding specifying No. Specify the 1st bit with the consecutive number of the 8-bit to be decoded (1 byte) or 16-bit (two bytes).

S3: Decode result address. Specify an address output the decoding result. The register area must be output with one byte or two bytes areas.

For example:

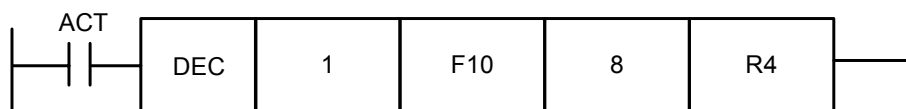

Fig. 5-15-2

When ACT=1, F10=8, R4=0000,0001;
 When ACT=1, F10=9, R4=0000,0010;

 When ACT=1, F10=15, R4=1000,0000;

5.16 COD (Binary System Code Conversion)

Function:

COD code may automatically produce a corresponding table under its function block when it inputs the data capacity, which is used for inputting the conversion table data for the user. 10 grids of each row in this table, it calculates based upon the quotient +1 if it can not be exactly divided, but the capacity data does not change, and then the address of the table number may not display.

Format:

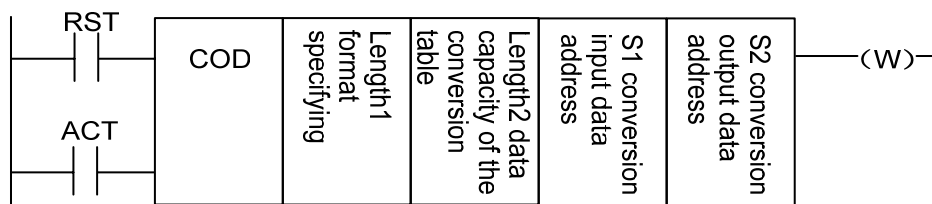

Fig. 5-16-1

Table 5-16-2

S1	0	1	2	9
S2	XXX	YYY	AAA
S1	10	11	12	N-1
S2	UUU

Controllable condition:

Reset (RST):

RST=0, Do not reset.

RST=1, It will output W resetting incorrectly

Working code (ACT):

ACT=0: Do not perform the COD.

ACT=1: Perform the COD. The value of the “conversion input data address (S1)” is regarded as the table number of the conversion table, the corresponding conversion data of the table number is taken out from conversion table to output the “output address to the conversion data (S2)”.

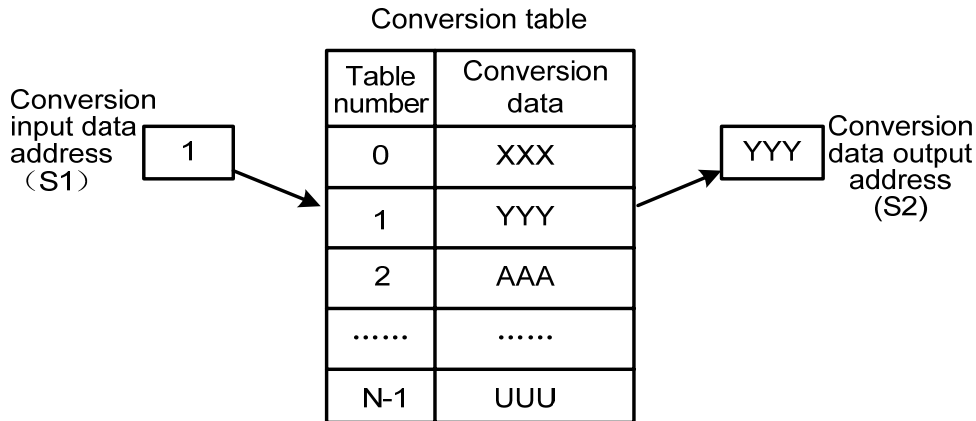

Fig. 5-16-2

Parameter:

Length1: Specify the byte number of the binary system data of the conversion data in the conversion table.

1: Binary system of 1 byte.

2: Binary system of 2 bytes.

Up to 512 bytes.

Length2: The capacity of the conversion table data. Each conversion table capacity can not more than 100, it is 100 bytes when 1 type format is specified; it is 100 bits when 2 bytes format are specified. The total capacity of the entire COD codes conversion table should be less than 512 bytes.

S1: The data in the conversion table can be taken out by the specifying table number, and the address of the specifying table number is regarded as the input address of the conversion data. This address should be supplied a register with one byte.

S2: The output address of the conversion data. Specify the byte numbers of the register in the form specification beginning with the address.

Output:

If the abnormal occurs during the COD code performs. W=1, it indicates that the error issues.

Note: The capacity of the conversion data table is up to 100 bytes (bits), this table is compiled between the parameter conversion data output address and error output (W).

5.17 COM (Concentric Line Control)

Function

COM specifies the control until the coil working within the public end code COME range. The system may alarm if the public end code does not specified.

Format:

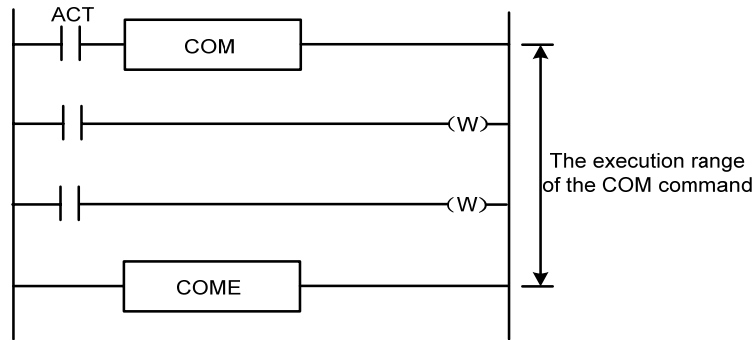

Fig. 5-17-1

Controllable condition:

When ACT=0, the coil within the specified range is cut off without any condition (W=0).

When ACT=1, it is same as the end of COM code.

Note 1: Do not specify another COM code within the range of one COM code.

Note 2: When the ACT = 0 of the COM, the coil within the specified range WRT NOT is set to 1 at any time (WRT NOT = 1).

Note 3: The function codes, such as JMPB, END1, END2, CALL, CALLU, LBL, SP, SPE, COM and COME, can not be used between COM and COME, otherwise the system may alarm.

5.18 COME (Concentric Line Control End)

Function:

This code is specified the controllable range of the concentric control line code (COM), which can not be used separately; it must be used with COM together.

Format

Fig. 5-18-1

5.19 ROT (Binary Rotation Control)

Function:

It is used for the revolving control, such as the tool post and rotation worktable. The code is with some functions, refer to the following:

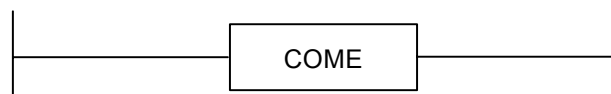
1. Select the revolving direction with the short path.

2. Count the steps from the current position to the objective one; or count the steps from the previous position of the current one to the previous position of the objective one.
3. Count the position number at the objective previous position or the steps at the objective previous position.

Format:

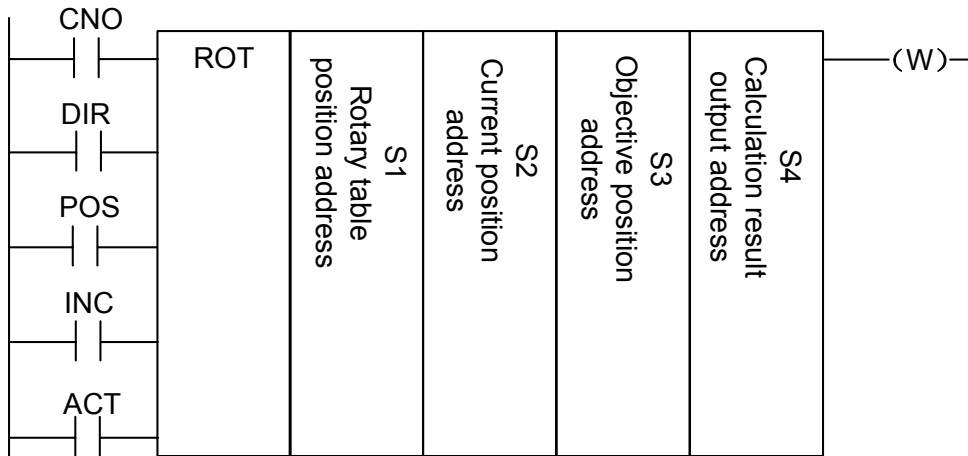

Fig. 5-19-1

Controllable condition:

Specify the initial number of the rotary table (CNO):

CNO=0, counter begins with 0.

CNO=1, counter begins with 1.

Check whether the short path can be selected the rotation direction (DIR):

DIR=0, Do not select; the selection direction is only positive.

DIR=1, Selection; the selection direction can be divided into positive or negative.

Specify the operation condition (POS):

POS=0, counting objective position

POS=1 the previous position of the counting object

Specify the position numbers and steps (INC):

INC=0, counting position number. Specify INC=0 and POS=1 if the previous position of the objective one is to be calculated.

INC=1, counting steps. Perform the code (ACT) when the code INC=1 and POS=0, if the distance between the current position and the objective one is to be calculated.

Performance code (ACT):

ACT= 0, do not perform the ROT code. W is without change.

ACT= 1, perform the ROT code. Generally, set the ACT=0, if the operation result is to be required, and then set the ACT=1.

Parameter:

S1 : Provide the rotary position number.

S2 : Provide the address storing the current position.

S3 : Specify the address (or code value) storing the objective position. For example, store the address of the T code outputting from the CNC.

S4 : The calculation outputs to address, compute the steps to be rotated of the rotary,

which reaches to the objective position or the previous position. Always check whether the ACT is 1 when using the calculation result.

Output:

W : Rotation direction output. It outputs to the W by the short-circuit rotation direction, its direction is positive (FOR) when W=0; it is the negative direction (REV) when W=1. The definitions of the FOR and REV are shown below, the increase direction of the position number of the revolving table is positive (FOR); it is the negative direction in the decrease state. The address of W can be selected freely, however, if the W results should be used, always check the condition of the ACT=1.

For example: One revolving table is shown below:

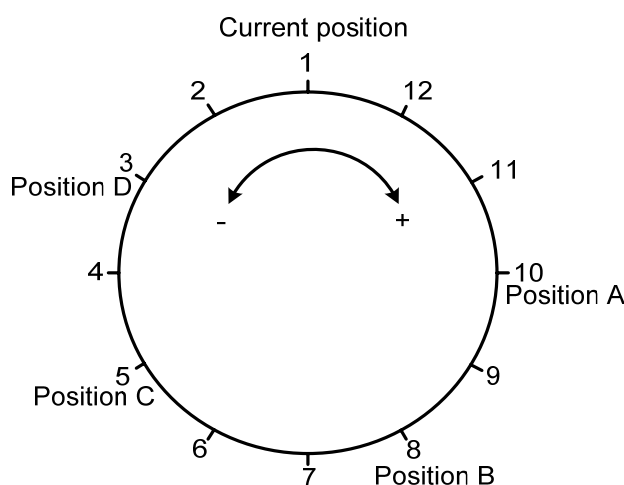

Fig. 5-19-2

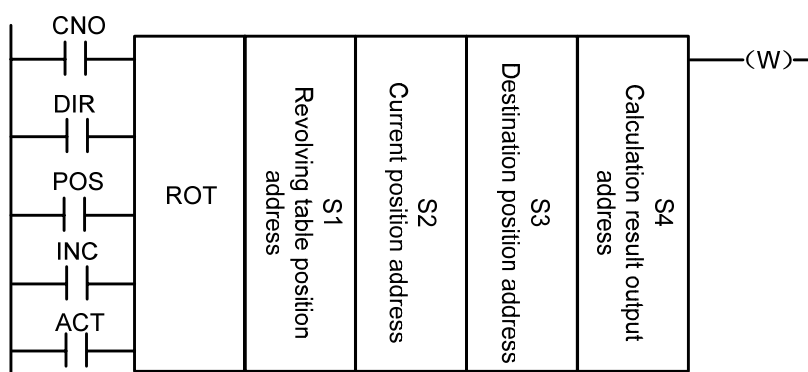

Fig. 5-19-3

Perform the short path rotation, and calculate the position No. of the previous one for the objection position.

Current position No. S2=1, revolving index position No. S1=12, CNO=1, DIR=1, POS=1 and INC=0

Wherein:

S3=10, S4=11, W=1, when the objective position is A in the ACT = 1.

S3=8, S4=9, W=1, when the objective position is B in the ACT = 1.

S3=5, S4=4 and W=0, when the objective position is C in ACT = 1.
 S3=3, S4=2 and W=0 when the objective position is D in the ACT = 1.

5.20 SFT (Register Displacement/Shifting)

Function:

This code can be shifted 1 byte (8-bit) based upon the digits specifying by the code parameter each time. The “1” that overflows from cycle shifting will be added from the negative direction, for example, the top bit “1” is overflowed when shifting to left, the lowest bit supplies “1”, vice versa.

Format:

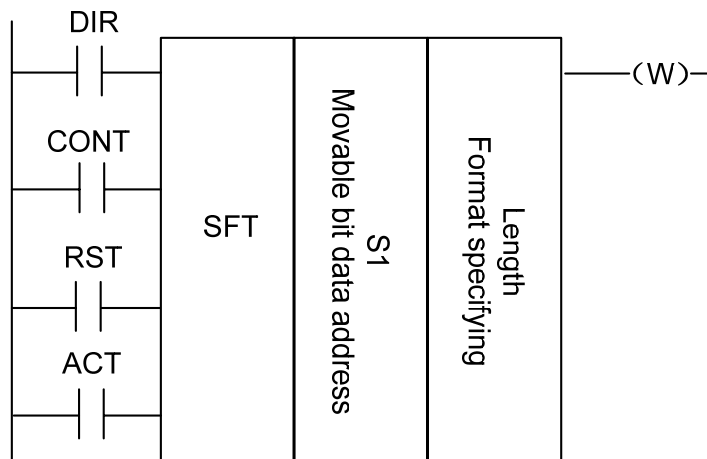

Fig. 5-20-1

Controllable condition:

Specify the shifting direction (DIR)

DIR=0, left shift

DIR=1, right shift

State specifying (CONT)

CONT=0, Do not perform the cycle shifting

CONT=1, perform the cycle shifting

Reset (RST)

Reset shifting output data (W=1) is (W=0)

RST=0, W does not reset

RST=1, W resets (W=0)

Execution condition (ACT)

ACT=0, Do not perform the SFT code.

ACT=1, Perform the shifting, set ACT to 0 after the code is performed, if only 1 bit is moved.

Parameter:

S1 : Set the shifting data address, it composes of one storage area by 1 byte.

Length: it is a 4-digit, which is shown in the following figure:

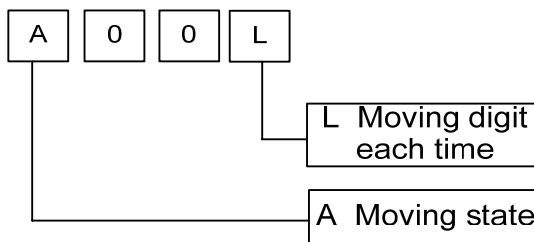

Fig. 5-20-2

L: its range is 0~8

A: It is treated as bit-parameter, it is always shifted when ACT =1 during A =0, and it moves once each period.

ACT is regarded as the pulse signal when A = 1, and when the value turns into 1 from 0, it moves once.

Output:

W : “1” state does not move out when the W = 0 shifting operation is performed.

“1” state moves out when the W = 1 shifting operation is performed.

5.21 DIFU (Rising Edge Detection)

Function:

This code is set the output signal to 1 during the scan period of the input signal rising edge.

Format

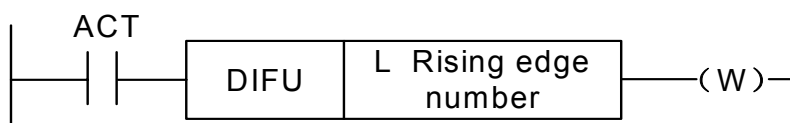

Fig. 5-21-1

Controllable condition:

Input signal: The output signal is set to 1 at the rising edge (0→1) of the input signal.

Output signal: The output signal keeps to 1 during one scan period of the ladder diagram when the function code is performed.

Parameter:

L : The range of the rising number is 0~255. The system alarm may occur when another DIFU code or DIFD code is used the same number in the ladder diagram.

Operation:

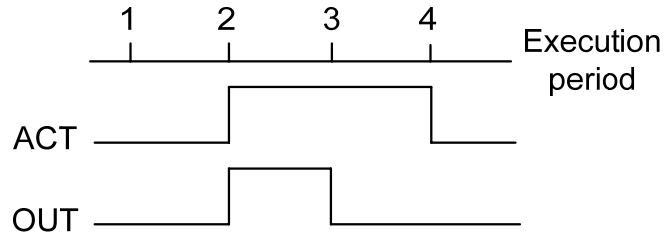

Fig. 5-21-2

The system may automatically check the range of the series number of the rising edge, as for the repeated series number or the exceeding range, the system alarm may occur.

5.22 DIFD (Descending Edge Detection)

Function:

This code outputs 1 signal of one scan period when inputting the signal descending edge.

Format:

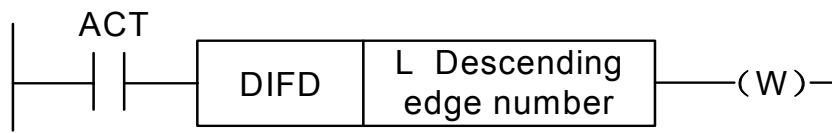

Fig. 5-22-1

Controllable condition:

Input signal: The output signal is set to 1 at the descending edge (1→0) of the input signal.

Output signal: The state in the output signal keeps one scan period of the ladder diagram when this function code is performed.

Parameter:

L : The range of the descending edge number is 0~255. The system alarm may occur when another DIFU code or DIFD code is used the same number in the ladder diagram.

Operation:

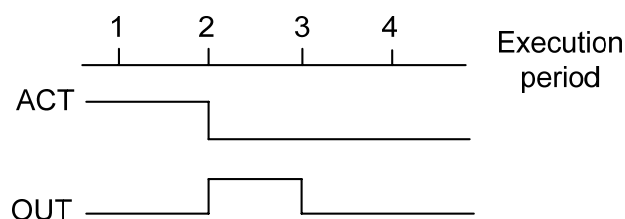

Fig. 5-22-2

The system may automatically check the range of the series number of the descending edge, as for the repeated series number or the exceeding range, the system alarm may occur.

5.23 COMP (Comparison of Binary Number)

Function:

Compare the dimensions of two binary number data. Specify the enough bytes to store the input data and comparison data in the memory block.

Format:

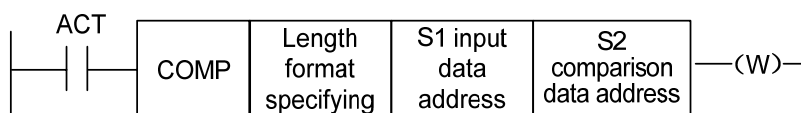

Fig. 5-23-1

Controlled condition:

ACT=0, Do not perform the COMP code. W value is invariable.

ACT=1, Perform the COMP code

Parameter:

Length: Input the specified format (constant or address) and the specified data length (1 byte or 2 bytes) of the data.

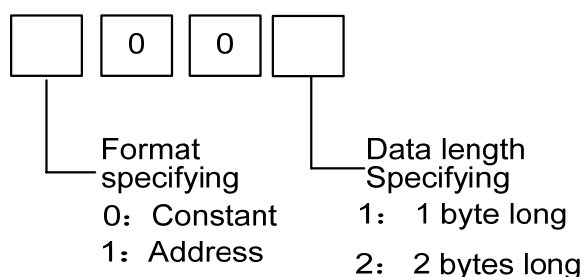

Fig. 5-23-2

S1, S2: The contents both the comparison 1 and comparison 2 can be regarded as constant and address number.

Address No.: Type R, X, Y, F, G, K, A, D and C

Output:

W =0: Data input > Data comparison

W = 1: Data input ≤ Data comparison

5.24 COIN (Consistency Comparison)

Function:

This code can be detected whether the input value and comparison value are consistent.

Format:

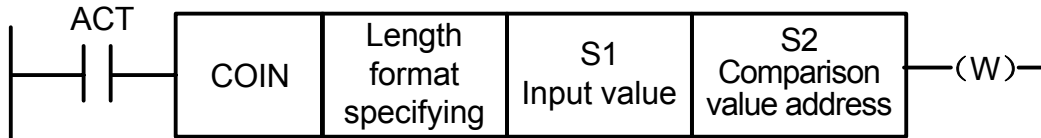

Fig. 5-24-1

Controllable condition:

ACT=0, Do not perform the COIN code. W value is invariable.

ACT=1, Perform the COIN code.

Parameter:

Length: Input the specified format (constant or address) and the specified data length (1 byte or 2 bytes) of the data.

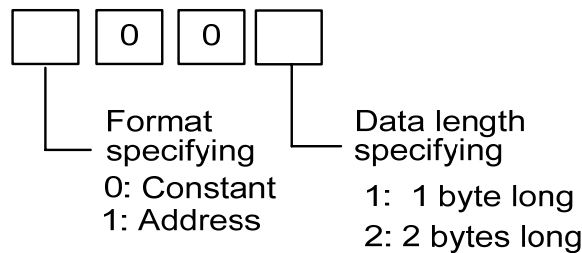

Fig. 5-24-2

S1 : The input data can be specified both the constant and storage address.

S2 : Compare the storage address of the data.

Output:

W : W = 0: input value ≠ comparison value

W = 1: input value = comparison value

5.25 MOVN (Data Transmission)

Function:

The data of the source address or the specified binary data is transferred to the destination address.

Format:

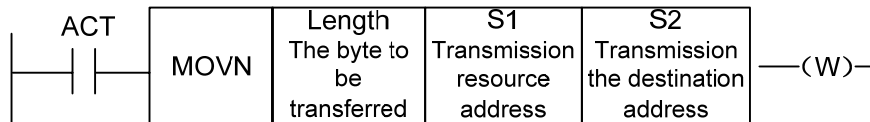

Fig. 5-25-1

Controllable condition:

ACT=0, No data to be transferred

ACT=1, The byte specified by the quantity is transferred.

Parameter:

Length: The byte numbers or data number to be transferred.

S1 : Resource start address or constant.

Select the transfer form based upon the S1:

1. If the S2 is single byte address, S1 is the constant, the resolution of the S1 based upon the byte is copied to the address where it is corresponding Length type at the beginning with S2; the S1 should be evaluated based upon the bit, if S2 is the bit address; the bit address corresponding Length begins with the S2 address.
2. The address type both S1 and S2 will not be considered whether it is matched, which is transferred the data by the byte address.

S2 : Destination start address.

For example:

Fig. 5-25-2

1. When S1 is regarded as constant 5, and the S2 is treated as R60, then R60=00000101

2. When S1 is regarded as constant 5, and the S2 is treated as D60, then D60=5.

3. When S1 is address D50, and S2 is treated as D60, then D60=D50.

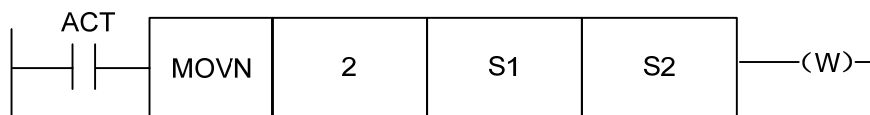
W=1, the specified quantity bytes are transferred.

W=0 No data transfer

The quantity range that exceeds the parameter type is detected when transferring, the system alarm may occur.

5.26 MOVN (Transmission of 1 Byte)**Function:**

The MOVB code transfers the 1 byte data to a specified destination address from a specified resource address.

Format:

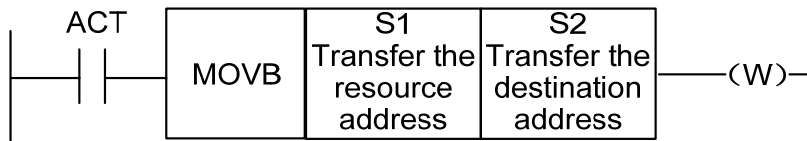

Fig. 5-26-1

Controllable condition:

ACT=0, No data transfers.

ACT=1, 1 byte is transferred.

Parameter:

S1 : Resource address or constant

If the S2 is single byte address, the S1 should be copied to the S2 address based upon the byte value; if S2 is bit address, the S1 should be copied to the S2 lower byte address based upon the byte value.

S2 : Destination address

5.27 MOVW (Transmission of Two Bytes)

Function:

MOVW code transfers the 2 bytes data to a specified destination address from a specified resource address.

Format:

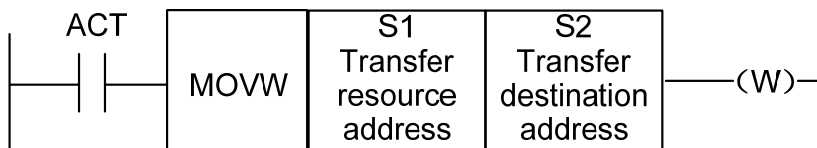

Fig. 5-27-1

Controllable condition:

ACT=0, No data transfers.

ACT=1, 1 byte is transferred.

Parameter:

S1 : Resource address or constant

S2 : Destination address

5.28 XMOV (Binary Indexed Data Transmission)

Function:

This function code is used to read or write the data from the data table. The data number (table-capacity) in this table can be specified by address; the data table can be operated by PLC based upon the user's setting during operating.

Format:

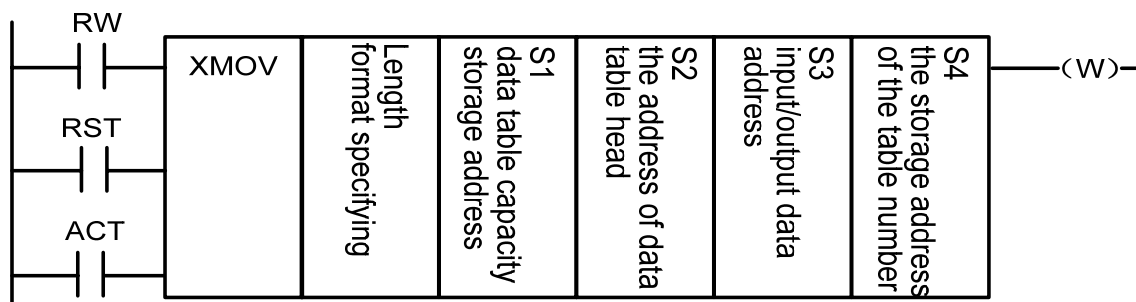

Fig. 5-28-1

Controllable condition:

Specify the operation (read or write) (RW)

RW=0: Read the data from the data table.

RW=1: Write the data to the data table.

Reset (RST)

RST=0: Release the reset

RST=1: Reset W=0.

Execution code (ACT)

ACT=0: Do not execute the XMOV code, W keeps invariable.

ACT=1: Execute the XMOV code.

Parameter:

Length: The format specifies the length of the transmission data.

1: 1 byte length.

2: 2 bytes length.

S1 : The data capacity storage address of the data table is used to store the data capacity of the data table; the occupied byte number should be suitable for the specified length of the Length. The valid range of the data is determined by the specified byte length of the Length 1 format.

1 byte length: From 1 to 512.

2 byte length: From 1 to 256, that is, $256 \times 2 = 512$ bytes, which is the capacity of the PLC data table.

S2 : Set the address of the data table head. The storage area of the data table = byte length \times data number of its table. The address of the table head should be the value in which is set inside the data table.

- S3 : Input/output address. Set and place the address from the reading when the data is read. Set and place the address from writing when the data is write. Its byte numbers should be suitable from the setting of the Length format. This address is defined as D register.
- S4 : Storage address of the table number. It is used to store the table number to be read or write. It occupied bytes should be suitable for the specifying in the Length. If the setting of the table number is more than the data registered in the S1, it outputs W=1 in a wrong way.

Output:

When the value in the table number exceeds the S1, W=1, the read or write of the data table does not perform.

- W=0, Without error
- W=1, Error

5.29 DSCH (Binary Data Index)

Function:

This function code can be use for indexing the binary data in the data table. The data number (table capacity) in the data table can be specified by address. In this case, the table capacity still can be changed even if the program is written into ROM.

Format:

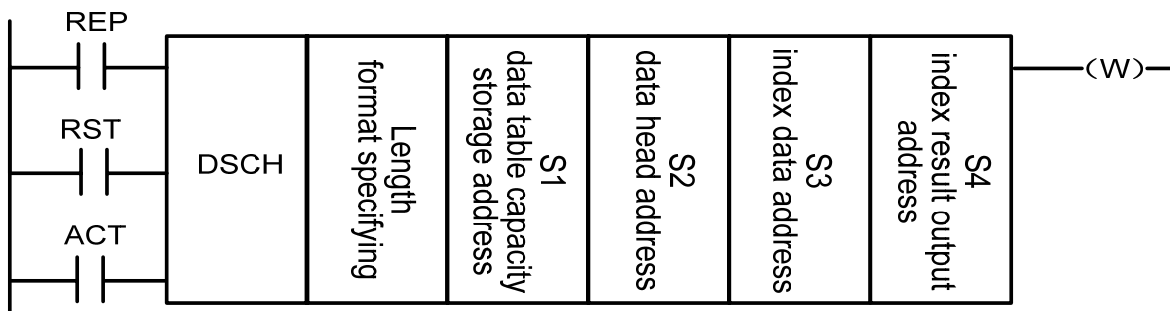

Fig. 5-29-1

Controllable condition:

Detection repetition (REP)

REP=0: Perform DSCH code, start to search it from the first address of the data table, it will not consider the destination data may generate repeatedly; it may stop the search outputting its address when detecting the destination data at the first time. W=1, if the indexed data does not find.

REP=1: Perform DSCH code. If the indexed data does not find or it has two or above data, W=1.

Reset (RST)

RST=0, Release the reset.

RST=0: Reset W=0.

Performance code (ACT)

ACT=0: Do not perform DSCH code, W keeps invariable.

ACT=1: Perform DSCH code. Output its table number if the indexed data is found; if it is not found or it has two more above data, W=1.

Parameter:

Length : Format specifies the length of the index data.

1: 1 byte long

2: 2 bytes long

S1 : Data number storage address of the data table. The byte length specified by this address is distributed the storage area for the requirement of the byte. The data number of the data table is n+1 (table head is 0, the end of the table is n).

S2 : Set the data table head address.

S3 : Set the input address of the index address.

S4 : The address output of the index result. Actual address = head address + table number, table number is 0~(S1-1), the actual address can not exceed the data table. After indexing: output its number from the list if the index data is found. The table number is outputted to the index result output address of which the required storage byte number should be suitable for the specified format.

Output:

W=0, Find the indexed data.

W=1, Do not find the indexed data.

5.30 ADD (Binary Addition)

Function:

This function code is used for the add operation of the 1 byte or 2 bytes binary data. The addend data and the add operation output the data should be set the storage address with the corresponding byte length.

Format:

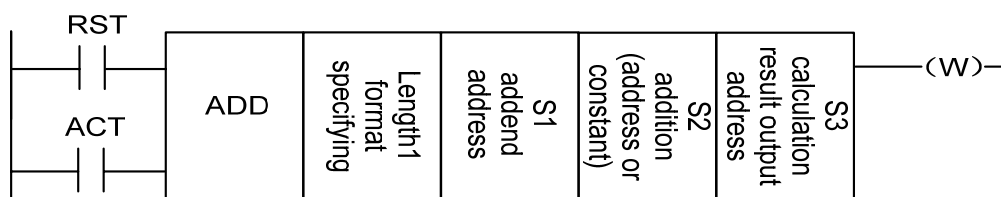

Fig. 5-30-1

Controllable condition:

Reset (RST):

RST=0 : Release the reset.

RST=1 : Reset W=0.

Execution code (ACT)

ACT=0: Do not execute ADD code, W keeps invariable.

ACT=1: Execute the ADD code.

Parameter:

Length : Specify the data length (1 byte or 2 bytes) and the specifying method of the addend (constant or address).

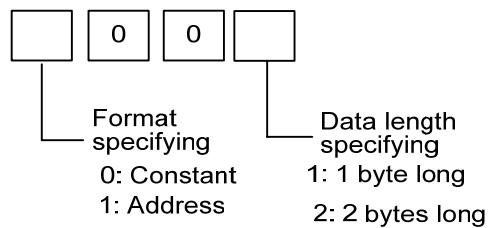

Fig. 5-30-2

S1 : Specify the storage addend address.

S2 : The specifying method of the addend is determined by the specification of the Length.

S3 : Specify the output operation address.

Output:

W=0: Operation is normal.

W=1: Operation is abnormal.

When the add operation result exceeds the specified data length, W=1.

5.31 SUB (Binary Subtraction)

Function:

This code is used for the subtraction of the 1 byte or 2 bytes binary data. The minuend and the subtraction output data should be set the storage address with the corresponding byte length.

Format:

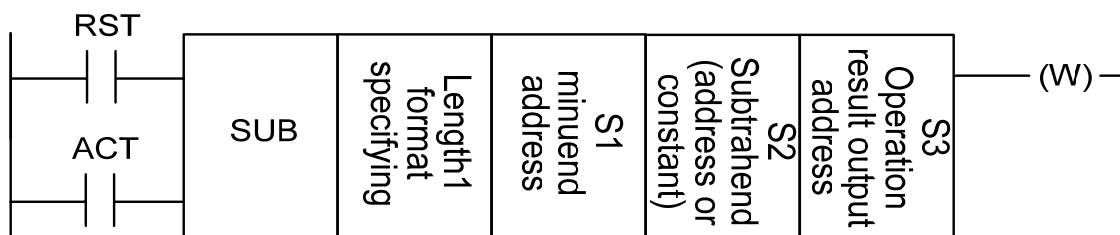

Fig. 5-31-1

Controllable condition:

Reset (RST):

RST=0: Release the resetting.

RST=1: Reset W=0.

Execution code (ACT):

ACT=0: Do not execute the SUB code, W keeps invariable.

ACT=1: Execute the SUB code.

Parameter:

Length: Data length specified (1 or 2 bytes) and the addend specifying method (constant or address).

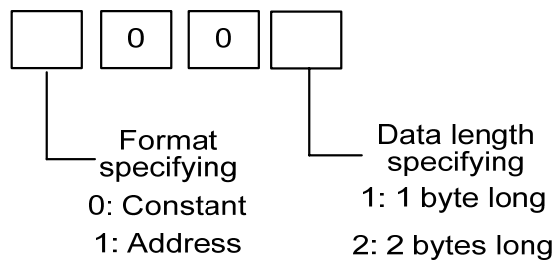

Fig. 5-31-2

- S1 : Specify and store the minuend address.
- S2 : The specifying method of the subtractor is determined by Length.
- S3 : Specify and output the address of the operation result.

Output:

W=0: Normal operation.

W=1: Abnormal operation.

The subtraction result exceeds the specified data length, W=1.

5.32 ANDF (Bit-by-bit AND)

Function

This code is performed the AND with a constant (or the content from the address B) from the content of the address A (or the one from the address B), and its result is stored to address C.

Format:

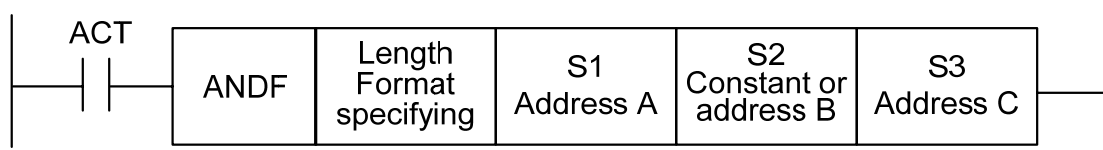

Fig. 5-32-1

Controllable condition:

ACT=0: Do not execute ANDF code.

ACT=1: Execute the ANDF code.

Parameter:

Length : Specify the data length (1 byte or 2 bytes), input the data format (constant or address).

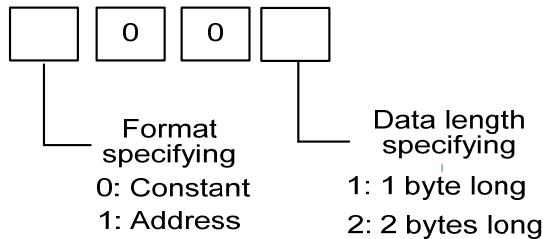

Fig. 5-32-2

- S1: Specify the input data that will to be performed by AND. The address is then begins and the data length is consistent with the Length.
- S2: The input data is performed with the one of the AND. When the format specifying is selected the address, the address is then started, and the data length is consistent with the length.
- S3: It is used for storing the address of ANDF operational result. The result from the ANDF is stored from this address, and the data length is consistent with the one of the Length.

For example: When the address A and B have the following data, which are shown below:

Address A	1	1	1	0	0	0	1	1
Address B	0	1	0	1	0	1	0	1

The operational result of the ANDF is shown below:

Address C	0	1	0	0	0	0	0	1
-----------	---	---	---	---	---	---	---	---

5.33 ORF (Bit-by-bit OR)

Function:

This code is performed the OR with a constant (or the content from the address B) from the content of the address A, and its result is stored to address C.

Format:

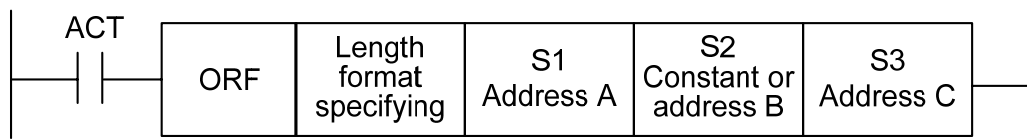

Fig. 5-33-1

Controllable condition:

ACT=0: Do not execute the ORF code.

ACT=1: Execute the ORF code.

Parameter:

Fig. 5-33-2

Length : Specify the data length (1 byte or 2 bytes), input the data format (constant or address).

S1 : Specify the input data that will to be performed by NOT. The address is then begins and the data length is consistent with the length.

S2 : The input data is performed with the one of the OR. When the format specifying is the address specification, and therefore, the address starts, and the data length is consistent with the specified Length..

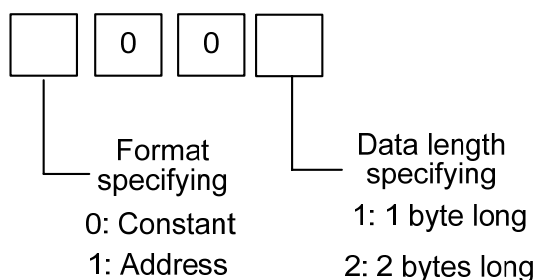
S3 : It is used for storing the address of ORF operational result. The result from the ORF is stored from this address, and the data length is consistent with the one of the length.

For example: When the address A and B have the following data, which are shown below:

Address A

1	1	1	0	0	0	1	1
---	---	---	---	---	---	---	---

Address B

0	1	0	1	0	1	0	1
---	---	---	---	---	---	---	---

The operational result of the ORF is shown below:

Address C

1	1	1	1	0	1	1	1
---	---	---	---	---	---	---	---

5.34 NOT (Bit-by-bit NOT)

Function: This code is reversed to each content in address A, and store the result to the address B.

Format:

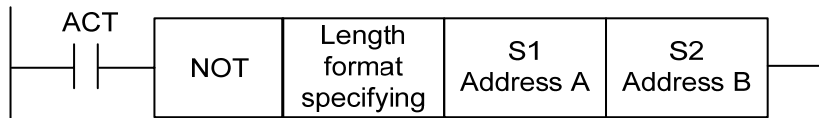

Fig. 5-34-1

Controllable condition:

ACT=0, Do not execute the NOT code.

ACT=1, Execute the NOT code.

Parameter:

Length: Specify the data length (1 byte or 2 bytes)

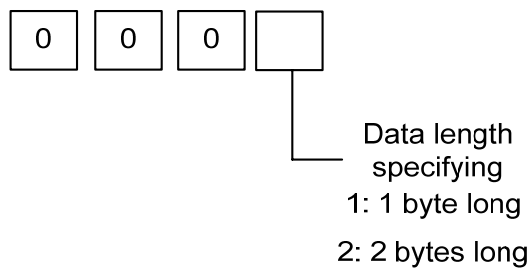

Fig. 5-34-2

S1 : The input data is reversed bit-by-bit. The address is started and the data length is consistent with the length.

S2 : It is used for outputting NOT operational result. The result of the NOT operation starts to store from this address, and the length of the data is consistent with the one of the length.

For example:

When the address A and B have the following data, which are shown below:

Address A	1	1	1	0	0	0	1	1
-----------	---	---	---	---	---	---	---	---

The operation result of the NOT is shown below:

Address B	0	0	0	1	1	1	0	0
-----------	---	---	---	---	---	---	---	---

5.35 EOR (Exclusive OR)

Function:

This code is performed the Exclusive OR with a constant (or the content from the address B) from the content of the address A, and its result is stored to address C

Format:

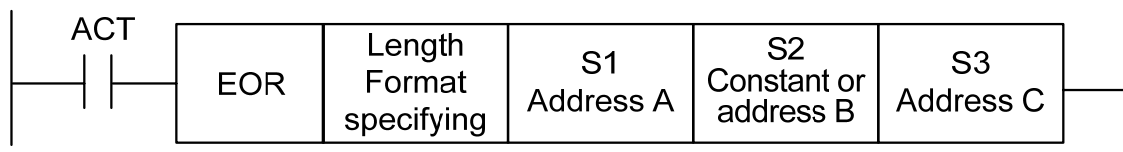

Fig. 5-35-1

Controllable condition:

ACT=0 : Do not execute the EOR code.

ACT=1: Execute the EOR code.

Parameter:

Length : Specify the data length (1 byte or 2 bytes), input the data format (constant or address).

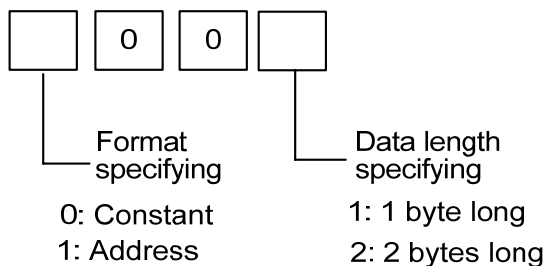

Fig. 5-35-2

- S1 : Specify the input data that will to be performed by Exclusive OR. The address is then begins and the data length is consistent with the length.
- S2 : The input data is performed with the one of the Exclusive OR. When the format specifying is selected the address, the address is then started, and the data length is consistent with the length.
- S3 : It is used for storing the address of EOR operational result. The result from the EOR is stored from this address, and the data length is consistent with the one of the length

For example: When the address A and B have the following data, which are shown below:

Address A	1	1	1	0	0	0	1	1
-----------	---	---	---	---	---	---	---	---

Address B	0	1	0	1	0	1	0	1
-----------	---	---	---	---	---	---	---	---

The operational result of the EOR is shown below

Address C	1	0	1	1	0	1	1	0
-----------	---	---	---	---	---	---	---	---

CHAPTER SIX COMPILATION LIMIT OF LADDER DIAGRAM

1. The program should with the codes END1 and END2, which are regarded as the end symbol of the 1st level and 2nd level program, and the END1 should be placed before END2.
2. It is only support the parallel output instead of the multi-level output.
3. The result output address in the overall basis codes, output function codes can not be set as the following addresses:
 - 1) Counter presetting address DC, timer presetting address DT.
 - 2) The addresses from K0 to K5 are occupied by system, user can not define it.
 - 3) The addresses G63, R510 and R511 are occupied by system, and therefore the user can not define it.
 - 4) X address and F address on the I/O input port.
4. The vertical hovering, the node point does not connect to the following node and the parallel conducting line is performed the parallel connection to the node network of which the above-mentioned circumstances will generate the node or network which can not be performed; and therefore, the system alarm occurs.
5. The start network, that is, it does not connect directly between different vertical lines in the same row; one of row does not consecutively connect to the vertical line. As for this case, the system can not be treated, and therefore the alarm occurs.
6. The upper embossment can not be accepted inside the network, that is, the parallel network generates on several nodes on one certain row, and any row of it can not be connected to this parallel network. The system alarm may issue.

The following cases are regarded as syntax error, the system alarm may occur.

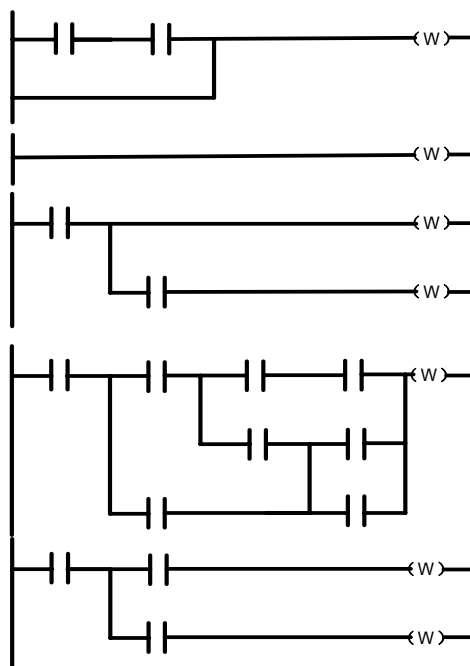



Fig. 6.1

VOLUME II OPERATION EXPLANATION

CHAPTER ONE PLC INTERFACE DISPLAY

1.1 GSK218MC Series Automatic Operation in PLC ON

PLC operates when the system is turned on: the 1st period may use the R510.0 to conduct a period of its network cables, the value of the R510.0 is then reset to “0”; the user can not output this value. The value of the nonvolatile relay is the one of the last output before PLC stops.

Note: The keys inside the < > in the following explanations are panel buttons; the keys inside the 【 】 is the soft button under the screen; 【 】 is the interface corresponding with the current soft key;  means that it includes submenu; all of the PLC operations are performed in the MDI mode, other methods only can be viewed and searched.

1.2 Program-Controlled Interface Display

1.2.1 INFO Interface

1. Enter the page by pressing the <program-controlled> key; enter the **INFO** interface pressing the **[INFO]** soft key, refer to the Fig. 1-2-1-1. Also, it can be set the <program-controlled> key to shift the screen in the PLC interface by defining the bit parameter **No: 26#6=1**, and then enter the **INFO** interface. This interface offers some relative information of this system, such as the version number, modification data etc.



Fig. 1-2-1-1

(1) The ladder diagram name in current operation is supplied on the interface. The ladder diagram

divides into three types: the only one ladder diagram in operating, the rest of 15 ladder diagrams other than the operation of the ladder diagram 0—15 and the other ladder diagrams for compiling and reference (Any two numbers can be identified or named other than 0-15).

- (2) The value of the system is set by bit parameter 53#0~#3 when the power is turned on initialization, which is the composed parameter of binary system; the No. 0 ladder diagram is used when this value is set to 0; when this value is set to 1~15, the No. 1~15 ladder diagrams are then used. The ladder diagram file for loading some one number is called operation file (this operation may cause hazard; it is enabled after restarting when the power is turned off). This file may be deleted to rebuild if the format is incorrect. So, the user should carefully specify the file name of the ladder diagram. The overall file names of the ladder diagram must be "ladderXX.grp" (XX is number), otherwise, the files may not be identified by the system. The file format is described by the system, the user can not modify it without the system; otherwise, it may be deleted or can not be identified.
- (3) M6 is separately called the macro program from O91000 to O91015 when the 0~15 ladder diagrams are used.
- (4) The selection of the ladder diagram. The file name can be specified by moving the cursor or inputting the "LX"/"LXX" (X/XX is number). The system may detect whether the X"/"XX is the known file name by pressing the "input" key. If it does not detect, the ladder diagram file should be set up based upon the file name "ladder0X.grp" or "ladderXX.grp". The system may automatically generate two function blocks "END1" and "END2" when the new file is set up, so that the user can consecutively operate this ladder diagram file (The command table remains null if it is converted after opening the file). User can copy or cut the ladder diagram from the normal file (it can not exceeds 100 rows, otherwise, only the previous 100 rows can be performed) pasting to other file, then copy the function (without modification), and then set up a new file. For safety's sake, after the ladder diagram is compiled, the current file may automatically stored when another file is opened; the ladder diagram syntactic may be detected before storing of which it may give up if the incorrect syntax is found.
- (5) The file header includes the basis information of the file such as the line number and step number, wherein, the step information occurs as long as it is converted, otherwise, it always keeps the opening information. User can delete the unopened and unoperated ladder diagram file; this operation is the irreversible operation, so user should be careful. The system may stop the renewal of the ladder diagram network after the user open the unoperated ladder diagram, in order to avoid the misguidance. The operating ladder diagram can only be stored and copied, so that user can copy this information to others ladder diagram files. It is better to stop the operation before compiling the current ladder diagram. When the cursor stops at the background compiling file, user can open the Info information to modify the compiling file background (including the ladder diagram version number, suitable machine and ladder

diagram maintainer) by the “modification” key.

1.2.2 PLCGRA Interface

Enter **PLCGRA** interface pressing the [**PLCGRA**] soft key, it also can be set the <Program-controlled> key to shift the screen in the PLC interface by defining the bit parameter **N0:26#6=1**, and then enter the **PLCGRA** interface. Refer to the **Fig. 1-2-2-1**:

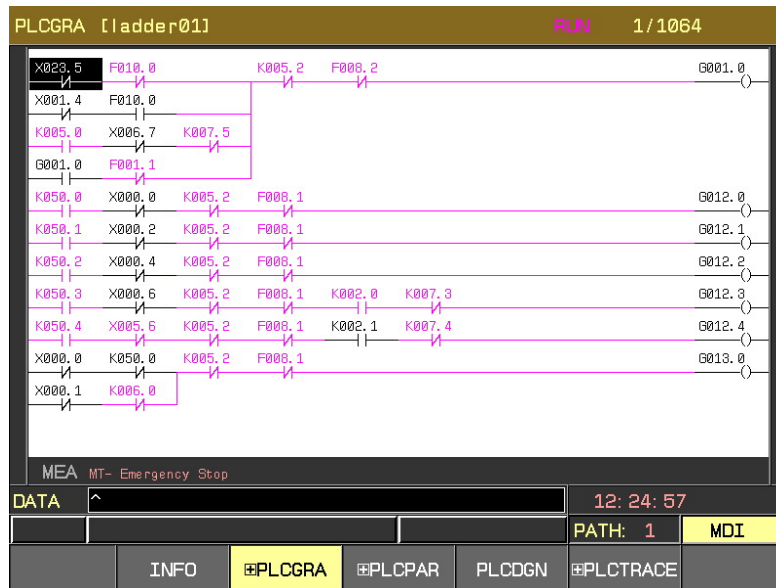

Fig. 1-2-2-1

The content and operation of the **PLCGRA** interface:

PLCGRA [ladder01]: Operate the current ladder diagram name.

1/972: It means that the cursor specified line is at the place of the ladder diagram.

Run: Ladder diagram operation state. The operation state of the ladder diagram includes RUN, STOP and DEBUG.

Figure area: Ladder diagram program

Input: Display the input data. The input data can be enquired pressing the  on the panel.

MEA: The note of cursor positioning node

MDI: Current working method (The ladder diagram can be modified only in the MDI mode).

The searching and positioning can be performed by the page-up, page-down and other direction keys, the components then can be viewed and modified.

1.2.3 PLCPAR Interface

Enter **PLCGRA** interface pressing the [**PLCGRA**] soft key, it also can be set the

<program-controlled> key to shift the screen in the PLC interface be defining the bit parameter **N0:26#6=1**, and then enter the **PLCGRA** interface. Refer to the **Fig. 1-2-3-1**:

PLCPARA		RUN							
ADDR	Bit7	Bit6	Bit5	Bit4	Bit3	Bit2	Bit1	Bit0	
K000	0	0	0	0	0	0	0	0	0
K001	0	0	0	0	0	1	0	0	
K002	0	0	0	0	0	0	0	1	
K003	0	0	0	0	0	0	0	0	
K004	0	0	0	0	0	0	0	0	
K005	0	0	0	0	0	0	0	1	
K006	0	0	0	0	0	0	0	0	
K007	1	0	0	0	0	0	0	0	
K008	0	1	0	0	0	1	0	1	
K009	0	0	0	0	0	0	0	0	
K010	0	0	0	0	0	0	0	0	
K011	0	0	0	0	0	0	0	0	

DATA		12: 25: 26
		PATH: 1 MDI
	INFO	PLCGRA
	PLCPAR	PLCDGN
	PLCTRACE	

Fig. 1-2-3-1

The content and operation of the **PLCPAR** interface:

RUN: The operation state of the ladder diagram

ADDR: Nonvolatile/keep relay address

Bit0~Bit7: Bit number state of the nonvolatile relay address

1: It means that this address remains the original state (before the power off);

0: It means that the address is rest to default state after the power is turned off.

Input: Display the input data.

MDI: Current working method. (**Note**: The relative parameters of the **PLCPAR** can be modified only in the MID mode.)

The searching and positioning can be performed by the page-up, page-down and other direction keys, the corresponding address then can be viewed and modified.

1.2.4 PLCDGN Interface

Enter the **PLCDGN** interface by **[PLCDGN]** soft-key, it also can be set the <Program-controlled> key to shift the screen in the PLC interface by defining the bit parameter **N0:26#6=1**, and then enter the **PLCDGN** interface. Refer to the **Fig. 1-2-4-1**.

PLCDGN		RUN							
ADDR	Bit7	Bit6	Bit5	Bit4	Bit3	Bit2	Bit1	Bit0	
F000	0	1	0	0	0	0	0	0	
F001	0	0	0	0	1	0	0	0	
F002	0	0	0	0	0	0	0	0	
F003	0	0	0	0	0	0	0	0	
F004	0	0	0	0	0	0	0	0	
F005	0	0	0	0	0	0	1	1	
F006	0	0	0	0	0	0	0	0	
F007	0	0	0	0	0	0	0	0	
F008	0	0	0	0	0	0	0	0	
F009	0	0	0	0	0	0	0	0	
F010	0	0	0	0	0	0	0	0	
F011	0	0	0	0	0	0	0	0	

DATA		12: 25: 47
		PATH: 1 MDI
	INFO	PLCGRA
	PLCPAR	PLCDGN
	PLCTRACE	

Fig. 1-2-4-1

The content and operation of the **PLCDGN** interface:

RUN: Operation state of the ladder diagram

ADDR: Address of diagnosis number

Bit0~Bit7: The bit number state of the diagnosis address. 1: with signal breakover; 0: without the signal breakover.

Input: Display the input data.

MDI: Current working method

The searching and positioning can be performed by the page-up, page-down and other direction keys, the corresponding diagnosis number then can be viewed and modified.

Generally, only the searching operation can be performed in the interface, the I/O terminal of the PLC enters signal debugging mode, after only the user gain the limit setting that K0.1 is set to 1, in this case, user can modify the X and Y signals.

1.2.5 PLCTRAE Interface

PLCTRA interface composes of two sub-interface “Setting” and “Trace”. Enter the PLCTRAE “Setting” interface by pressing the [PLCTRAE] soft key under the screen.

Refer to the **Fig. 1-2-5-1** for PLCTRAE “Setting” interface:

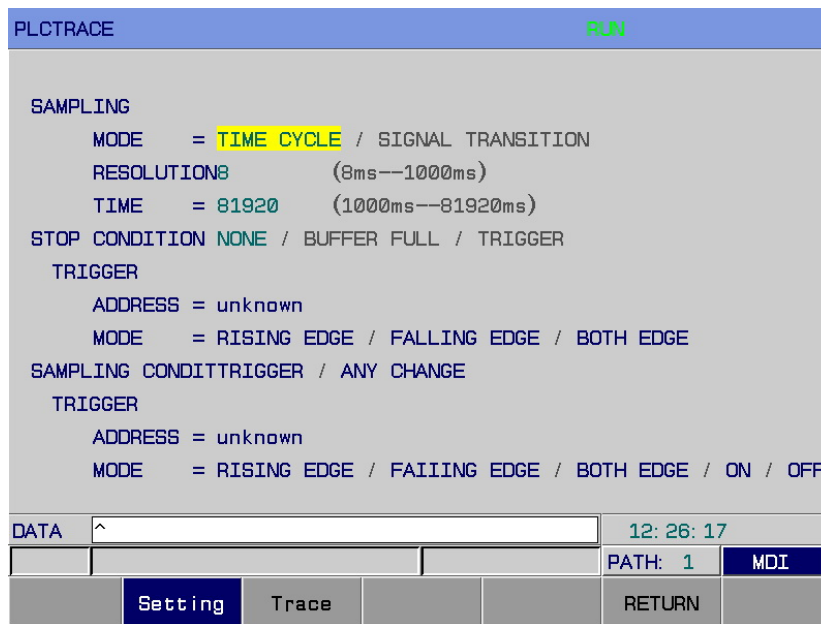

Fig. 1-2-5-1

The content and operation of the **PLCTRAE** “Setting” interface

(1) Mode:

- - Circular cycle: periodic sampling for each time.
- - Signal change: sampling when signal changes.

(2) Resolution:

Input the sampling resolution, the default value is the least resolution (8ms), its range is (8ms --1000ms).

The input value uses the multiple of the 8ms.

(3) Time limit:

When the sampling mode is set to “periodic cycle”, this parameter then displays. Input the performance time of the trace. The numerical range of the “periodic cycle” is determined by the value of the “resolution” or the specified signal address quantity, and its range is displayed at the right side.

(4) Frame limit:

When the sample mode is set to “signal change”, then display this parameter. Input the sampling quantity, and its range is displayed at the right side.

(5) Stop condition:

- - without: Do not stop tracing.
- - Buffer area full: It stops tracing when the buffer area is full.
- - Signal trigger: It stops tracing by the signal trigger.

Trigger setting: This parameter is enabled when the “stop condition” is selected to the “signal trigger”.

- ① Address: The input signal address is regarded as trigger stopping. (R address can not be used for trigger stopping)

② Mode: It determines that what kind trigger mode is used to stop tracing.

Rising edge: The tracing is automatically stopped by the rising edge of the trigger signal.

Falling edge: The tracing is automatically stopped by the falling edge of the trigger signal.

Any change: The tracing is automatically stopped by the rising or falling edge of the trigger signal.

(6) Sampling condition: This parameter is enabled when the sampling mode is set to “signal change”, which is determined the sampling condition.

- - Signal trigger: The specified mode changes when the signal specified by the trigger address which is set by the sampling condition, collect the signal.

- - Any change: Any change occurs when the signal specified by the trigger address which is set by the sampling condition.

Trigger setting: When the sampling mode is set to “signal change”, and then the sampling condition is set to “signal trigger”, this parameter is enabled.

① Address: The input signal address is treated as the sampling of the trigger signal. (The R address can not regarded as the sampling trigger)

② Mode: The trigger mode inputs the specified trigger signal.

Rising edge: The rising edge sampling of the trigger signal specifies the signal state.

Falling edge: The falling edge sampling of the trigger signal specifies the signal state.

Any change: Specify the signal state by the rising or falling edge sampling of the trigger signal.

Switch on: Sample the specified signal state when the trigger signal is switched on.

Switch off: Sample the specified signal state when the trigger signal is switched off.



Enter the **PLCTRACE** “trace” interface by pressing the **[trace]** soft key. Refer to the Fig. 1-2-5-2:





Fig. 1-2-5-2

The content and operation of the **PLCTRACE** “trace” interface

- (1) Sampling mode: Display the current sampling mode of the system.
- (2) Period: Display the current sampling period of the system, that is, resolution.
- (3) Time: This parameter displays when the “sampling mode” selects the “periodic cycle”.
 - - Format display when tracing: the current timing is at the left side, and the max. allowance timing is at the right side.
 - - Format display when stopping: the most right side timing is placed at the right side; the timing of trace stopping is placed at the middle side, and the max. allowance timing is placed at the right side.

- (4) Setting address: Move the cursor by the  and , the signal address that will be traced is inputted inside the , it can be traced 15 signals at the same time. Any address can be inputted. As for the R address, the previous 3 positions can be inputted the address before 256; the 4th and 5th position can be inputted 2 addresses after 255.

- (5) (S) start: The signal trace can be performed pressing  key after the trace parameter is set correctly.

- (T) Stop: Stop the signal trace after controlling the  key.

Clear: Clear the value under the cursor pressing the  key.

CHAPTER TWO PLC PROGRAMMING OPERATION

2.1 Brief

The PLC operations of the GSK218MC serial are completed corresponding interface in the system. The overall modification of the ladder diagrams should be performed after gaining the limitation higher than the debugging.

GSK218MC series operations can be performed within two interfaces.

1. Enter PLCGRA classification interface pressing **[PLCGRA]** twice, refer to the **Fig. 2-1-1**:
The **PLCGRA** interface consists of basis code, function code, command table and edit command.

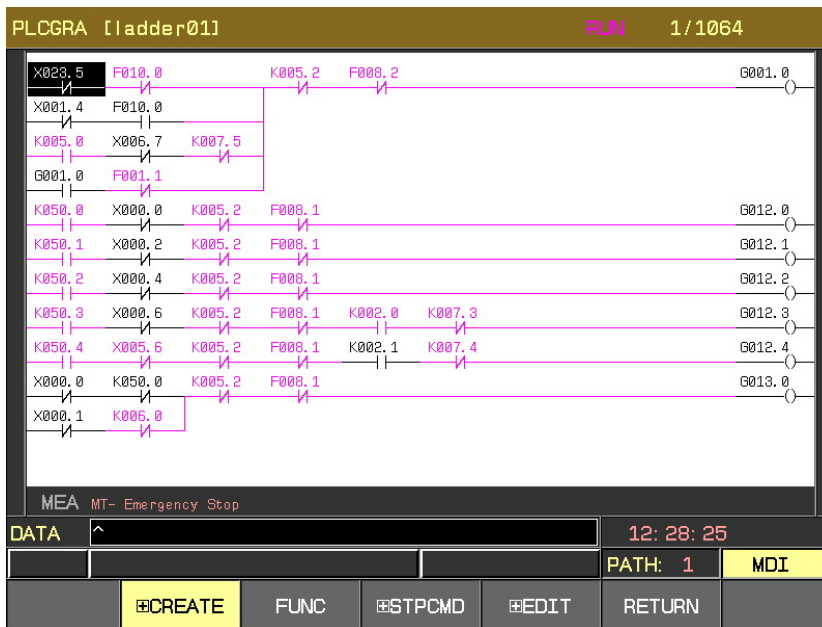

Fig. 2-1-1

2. **PLCPAR** interface includes KPAR, TMR, DATA, CTR and MDEC.

Enter PLCRAR interface pressing the **[PLCPAR]** soft key, refer to Fig. 1-2-3-1. Enter the PLCPAR classification operation interface by controlling **[PLCRAR]** again, refer to the Fig. 2-1-2. The parameter modification, PLC operation state control and entering the I/O debugging mode should be performed after the limitation above the debugging is gained. Refer to the Chapter Three for details.

PLCPARA		RUN							
ADDR	Bit7	Bit6	Bit5	Bit4	Bit3	Bit2	Bit1	Bit0	
K000	0	0	0	0	0	0	0	0	
K001	0	0	0	0	0	1	0	0	
K002	0	0	0	0	0	0	0	1	
K003	0	0	0	0	0	0	0	0	
K004	0	0	0	0	0	0	0	0	
K005	0	0	0	0	0	0	0	1	
K006	0	0	0	0	0	0	0	0	
K007	1	0	0	0	0	0	0	0	
K008	0	1	0	0	0	1	0	1	
K009	0	0	0	0	0	0	0	0	
K010	0	0	0	0	0	0	0	0	
K011	0	0	0	0	0	0	0	0	

DATA	^	12: 28: 40
		PATH: 1 MDI
KPAR	TMR	DATA
CTR	RETURN	▶

Fig. 2-1-2

2.2 Basis Code

Enter the basis command operation interface pressing the **[Basis command]** soft key in the Fig. 2-1-1. Refer to the Fig. 2-2-1.

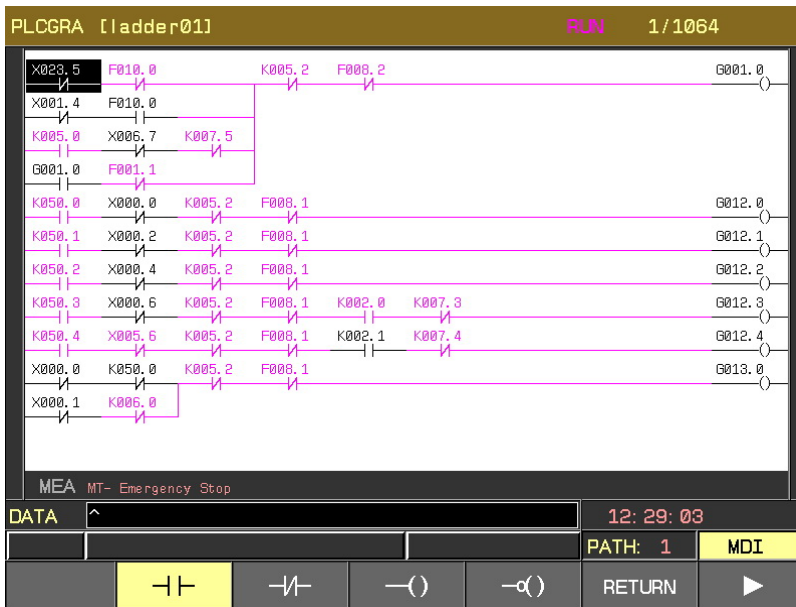

Fig. 2-2-1

Display other basis codes pressing the **[▶]** key. Refer to Fig. 2-2-2.

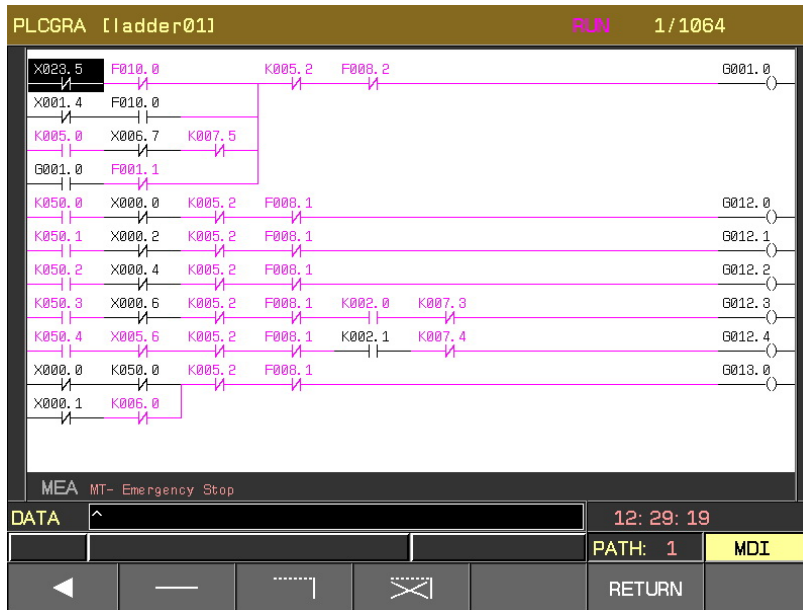











Fig. 2-2-2

The basis codes are separated into 7 kinds figures as follows:

- []: Normally opened contact
- []: Normally closed contact
- []: Output coil
- []: Output coil reverse
- []: Horizontal breakover cable
- []: Vertical breakover cable
- []: Delete the vertical breakover cable

Miscellaneous soft keys:











- []: Page-down
- []: Page-up
- [Return]: Return to the last menu

2.3 Operation Explanation of Ladder Diagram

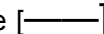
- Add component: positioning the cursor to the place where the component is needed to be added, input the component name in according to the corresponding menu, the display is then appeared after the data; the corresponding components can be added pressing the



key on the panel. If the component has been positioned at the current place, the new one may replace the old one.

- Insertion component: Positioning the cursor to the place where is required to insert the component; a vacancy is inserted in this place pressing the  key, and then add the new component pressing the steps of the add component. The cursor can be inserted in turn.
- Component Deletion: Delete the current component pressing the  key on the panel.
- Add the vertical breakover cable: Add a vertical breakover cable at the lower right corner of the current cursor by pressing the [] soft key.
- Delete the vertical breakover cable: The vertical breakover at the lower right corner of the current cursor can be deleted by pressing the [] soft key.
- Add a horizontal breakover cable: a horizontal breakover cable can be inserted at the current cursor place by pressing the [] soft key; the horizontal breakover cable may replace the component which has been performed at the current position.
- Row insertion: The cursor is positioned at any destination row, firstly press the  on the panel, then press the  key, and therefore a new row is inserted above the specified row of the cursor. The followings rows are moved down in turn.
- Row deletion: The cursor is positioned at the destination row, firstly press the  on the panel, then press the  key, the current row is then deleted, the following rows are moved up in return.
- Block deletion: The cursor is positioned as the start position where to be deleted, then input the address of the output coil of the desired deletion block, and then press the  key on the panel.
- Search: Directly input the component name what you want to reach, it will display at the

data column on screen, upward or downward search by pressing the

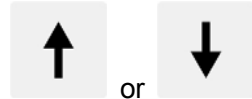



or

after inputting.

- Save: The modified ladder diagram is saved by pressing the  key.

Illustrations of the ladder diagram programming:

1. The cursor is positioned as the start place of the programming position, a normally opened contact symbol occurs at the cursor's positioning by  soft key, directly input the

component name X1.4, affirm it by pressing the  key, the component X001.4 appears on the current cursor position.

2. Rightward one place of the cursor, press the  soft key, a symbol of the normally closed contact occurs at the cursor positioning, directly input component name X2.1, affirm it by

pressing the  key, and then the X002.1 appears at the current cursor position.

3. The cursor is positioned at the next start position, press the  soft key, a symbol of the normally opened contact occurs at the cursor positioning, direct input the component name

X2.4, affirm it by pressing the , the component then appears at the current cursor position

4. Rightward one place of the cursor, press the  soft key, draw a horizontal breakover line at the current cursor position;

5. Upward one place of the cursor, press the  soft key, draw a vertical breakover line at the lower right corner of the cursor.

6. Press the  soft key, the output coil is automatically generated (the required horizontal breakover line), and then the output coil is produced at the right side of the ladder diagram.

Directly input the component name G1.0, affirm it by pressing the , the component G001.0 occurs at the current cursor position.

The compiled ladder diagram is shown in the **Fig. 2-3-1**:

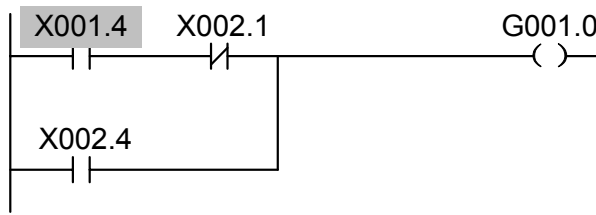

Fig. 2-3-1 Ladder diagram illustration

Explanation: The green component indicates connection state in the ladder diagram regardless of the normally opened, normally closed or output coil, and the white one means disconnected state. (The dark color is disconnection state, the light color is connected state due to the printing)

2.4 Function Code

Press the **[Function command]** soft key in the Fig. 2-1-1, then enter the function code operation interface, refer to the Fig. 2-4-1.

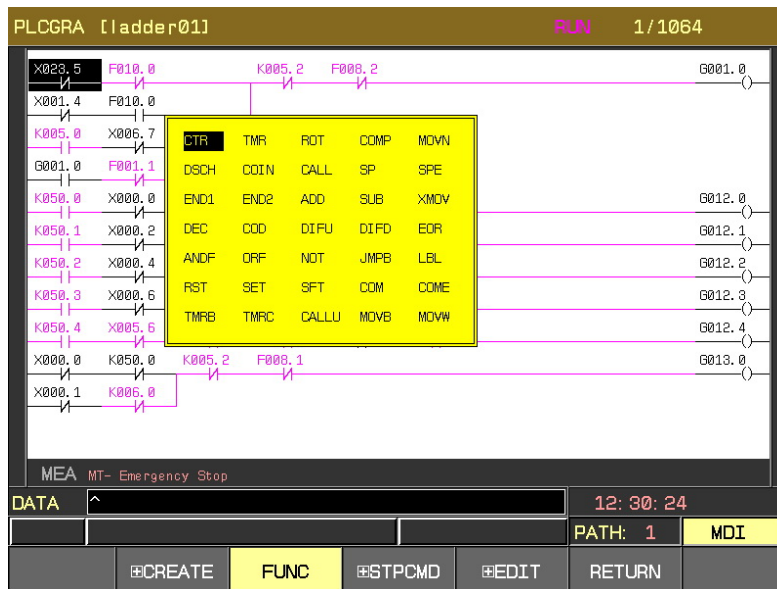

Fig. 2-4-1

There are 35 PLC function codes listed in the function code. Refer to the Chapter Two Programming for function code format and usage, the compilation of the function code is consistent with the ladder diagram operation in the Section 2.3.

2.5 Command Table

In the PLCGRA interface, as the **Fig. 2-1-1**. Press the **[Command table]** soft key again, and then enter the command table classification operation interface, refer to the **Fig. 2-5-1**.

PLCREPER		RUN	1/3354
NO.	REPER		
0001	RD. NOT X023. 5		
0002	AND. NOT F010. 0		
0003	RD. NOT X001. 4		
0004	AND F010. 0		
0005	OR. STK		
0006	RD K005. 0		
0007	AND. NOT X006. 7		
0008	AND. NOT K007. 5		
0009	OR. STK		
0010	RD G001. 0		
0011	AND. NOT F001. 1		
0012	OR. STK		

DATA	^	12:30:42
		PATH: 1 MDI
CONVERT	DOWN	STOP
		RETURN

Fig. 2-5-1

The content and operation of the command list:

1/3070: Offer the steps and total steps information of in the current operation of the ladder diagram.

RUN: the operation state of the ladder diagram

Input: Display the input data.

MDI mode: current working method.

[Conversion]: Ladder diagram converts to the command list.

[Download]: Download the command list to the CNC, automatically operate the PLC ladder diagram.

[Stop]: Stop the operation of the ladder diagram.

[Return]: Return to the previous menu.

The positioning can be performed by the page-up, page-down and four direction keys, and then check the command list.

2.6 Compilation Command

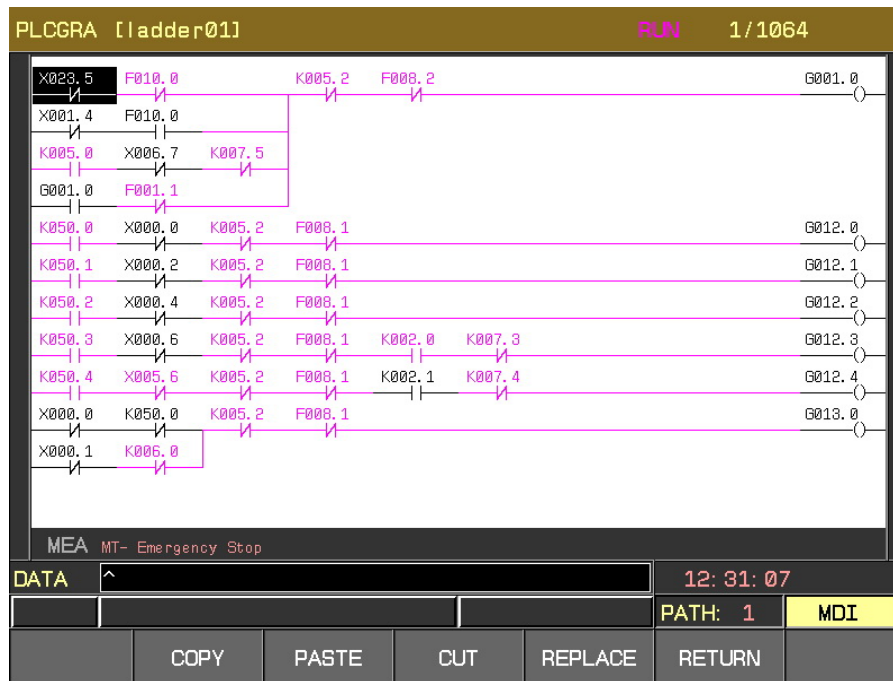

Fig. 2-6-1

The content and operation of the command list interface:

1/972: Display the current position of the cursor and the total line number of the ladder diagram.

RUN: The operation state of the ladder diagram.

Input: Display the input data.

MDI mode: Current working mode.

[Copy]: Press this key after entering G12.1, the ladder diagram between cursor and G12.1 can be duplicated.

[Paste]: Paste the copied diagram to the ladder diagram.

[Deletion]: Press this key after entering the G12.1, the ladder diagram between the cursor and G12.1 can be deleted.

[Replacement]: Input the replaced the signal address, then press this key, the system may prompt whether it is replaced or replaced completely.

Y: Replaced; N: Do not replace; A: Replaced completely

[Return]: Return to the previous menu.

The search positioning can be performed by the page-up, page-down and four direction keys on the panel, then check the command list.

2.7 PLC Operation Steps

PLC operation steps:

1. Press <Set> key, input the password higher level than the machine tool builder in the **[Password]** interface.
2. Press the <Program-controlled> key, in [PLCPAR] interface, enter the check and setting interfaces of the hold/nonvolatile relay by pressing the [KPAR] soft key. The PLC can be operated modifying the relative bit of the K000 and K001. (For example, K000.7 is set to 1, then memories). Refer to the K code list of the Appendix in the Chapter Four Installation Connection for the definition of the relative bit.
3. Press the **[Command list]** soft key in the **[PLCGRA]** interface, then press the **[Stop]** soft key in the interface, the ladder diagram of current operation is stopped. (This step can be ignored if the current ladder diagram does not modify).
4. The modification of the PLC program compilation is completed by the **[Basis command]**, **[Function command]** and **[compilation command]** in the **[PLCGRA]** interface. Press the <Save> key, the data column prompts: "Ladder diagram saves successfully!" means that the save is performed. When some incorrect compilation occurs in the PLC, the corresponding alarm may display during storing, check the PLC program.
5. The data column may display: "the ladder diagram is converting..." by pressing the [Command list] soft key in the [PLCGRA] interface, then control the [Conversion] soft key. "Successfully convert"! displays after converting.
6. The data column may display: "the command list is downloading" by pressing the [Command list] soft key in the [PLCGRA] interface, then press the [Download] soft key. "Successfully download!" displays after the downloading is performed. The ladder diagram is converted into the command list downloading to the CNC and then it operates automatically.

CHAPTER THREE PLC ADDRESS AND PARAMETER SETTING

The addresses and parameters, such as the counter, timer, data list and nonvolatile relay may be used in the PLC; the viewing and setting of these addresses and parameters should be performed in the corresponding interface. Press the **[PLCPAR]** soft key again in the PLCPAR interface, then enter the PLC address and parameter setting interfaces, refer to the **Fig. 3-1**, which includes the nonvolatile relay, timer, data list, counter, F address corresponding with the M function. It is used for checking and setting these addresses, parameters and data list. (User can set it after the debugging password is input and gained an authority)

PLCPARA		RUN							
ADDR	Bit7	Bit6	Bit5	Bit4	Bit3	Bit2	Bit1	Bit0	
K000	0	0	0	0	0	0	0	0	
K001	0	0	0	0	0	1	0	0	
K002	0	0	0	0	0	0	0	1	
K003	0	0	0	0	0	0	0	0	
K004	0	0	0	0	0	0	0	0	
K005	0	0	0	0	0	0	0	1	
K006	0	0	0	0	0	0	0	0	
K007	1	0	0	0	0	0	0	0	
K008	0	1	0	0	0	1	0	1	
K009	0	0	0	0	0	0	0	0	
K010	0	0	0	0	0	0	0	0	
K011	0	0	0	0	0	0	0	0	

DATA	^	12:32:07
		PATH: 1 MDI
KPAR	TMR	DATA
CTR	RETURN	▶

Fig. 3-1

3.1 Nonvolatile/Hold Relay

Press the **[KPAR]** soft key in the **Fig. 3-1**, then enter the checking and setting interfaces of the nonvolatile replay, refer to the **Fig. 3-1-1**.

PLCPARA		RUN							
ADDR	Bit7	Bit6	Bit5	Bit4	Bit3	Bit2	Bit1	Bit0	
K000	0	0	0	0	0	0	0	0	
K001	0	0	0	0	0	1	0	0	
K002	0	0	0	0	0	0	0	1	
K003	0	0	0	0	0	0	0	0	
K004	0	0	0	0	0	0	0	0	
K005	0	0	0	0	0	0	0	1	
K006	0	0	0	0	0	0	0	0	
K007	1	0	0	0	0	0	0	0	
K008	0	1	0	0	0	1	0	1	
K009	0	0	0	0	0	0	0	0	
K010	0	0	0	0	0	0	0	0	
K011	0	0	0	0	0	0	0	0	

DATA	^	12: 32: 07
		PATH: 1 MDI
KPAR	TMR	DATA
CTR	RETURN	▶

Fig. 3-1-1

The content and operation of the nonvolatile replay interface:

RUN : Ladder diagram operation state.

ADDR : Nonvolatile relay address.

Bit0~Bit7 : Bit number state of the nonvolatile replay address.

1: This address remains the state before power off after the power is turned off;

0: This address resets on default state after the power is turned off.

Input : Input data display.

MDI mode : Current working mode.

[Return] : Return to the previous menu.

[▶] : Enter next page.

The set value can be downloaded to the CNC operation pressing the <Save> key after modifying. “KPAR downloading successful” displays after the save is performed; the system displays: “downloading fail” when the save is incorrect; the “illegal downloading parameter” displays without downloading conditions.

(Note: It can be saved and operated by pressing the <Save> after modifying. K000~~K005 are used by the system. Refer to the Appendix One and Three for details)

The search and positioning can be performed by the page-up, page-down and four direction keys on the panel; checking and modifying of the nonvolatile relay address can be performed.

3.2 Timer

Press the [TMR] soft key in the Fig. 3-1, then enter the checking and setting interfaces of the timer, refer to the Fig. 3-2-1.

PLCPARA					RUN
NO.	ADDR.	CURT.	SET.	REMARK	
036	T036	00500	00500	Indextable release finish delay	
037	T037	00500	00500	Indextable clamp finish delay	
038	T038	05000	05000	Indextable release check delay	
039	T039	05000	05000	Indextable clamp check delay	
040	T040	00500	00500	Indextable clamp delay	
041	T041	02000	02000	Probe start delay finish	
042	T042	00000	00000	STANDBY	
043	T043	00000	00000	STANDBY	
044	T044	00000	00000	STANDBY	
045	T045	00000	00000	STANDBY	
046	T046	00000	00000	STANDBY	
047	T047	00000	00000	STANDBY	

DATA	^	09: 22: 56
		PATH: 1 MDI
KPAR	TMR	DATA
	CTR	RETURN
		▶

Fig. 3-2-1

The content and operation of the timer:

- RUN** : Operation state of ladder diagram.
- NO.** : Timer serial number; Do no change it.
- ADDR.** : Timer address; Do not change it.
- CURT** : Current value of the timer; Do not change it.
- SET** : Presetting value of the timer; it can be changed after the K000.0 (PLC parameter allows to be modified) is set 1 in the MDI mode.
- Input** : Input data display
- MDI mode** : Current working mode
- [Return]** : Return to the previous menu
- [▶]** : Enter to the next page.

The set value can be downloaded to the CNC operation pressing the <Save> key after modifying. "TMR downloading successful" displays after the save is performed; the system displays: "downloading fail" when the save is incorrect; the "illegal downloading parameter" displays without downloading conditions.

The search and positioning can be performed by the page-up, page-down and four direction keys on the panel; checking and modifying of the timer address can be performed.

3.3 Data List

Press the **[DATA]** soft key in the Fig. 3-1, then enter the checking and setting interface of the data list, refer to the **Fig. 3-3-1**.

PLCPARA		RUN	
NO.	ADDR.	DATA	REMARK
000	D000	00000	Spindle tool No. dis.
001	D001	00001	No.1 tool No.
002	D002	00002	No.2 tool No.
003	D003	00003	No.3 tool No.
004	D004	00004	No.4 tool No.
005	D005	00005	No.5 tool No.
006	D006	00006	No.6 tool No.
007	D007	00007	No.7 tool No.
008	D008	00008	No.8 tool No.
009	D009	00009	No.9 tool No.
010	D010	00010	No.10 tool No.
011	D011	00011	No.11 tool No.

DATA	^	09:16:27
		PATH: 1 MDI
KPAR	TMR	DATA
CTR	RETURN	▶

Fig. 3-3-1

The content and operation of the data list:

RUN : The operation state of the ladder diagram.

NO. : Serial number of the data list; Do not change it.

ADDR. : Data list address; Do not change it.

DATA : Data list setting value; it can be changed after the K000.0 (PLC parameter allows modification) is set to 1 in the MDI mode.

Input : Input data display.

MDI mode : Current working mode.

[Return] : Return to the previous menu.

[▶] : Enter to the next page.

The set value can be downloaded to the CNC operation pressing the **<Save>** key after modifying. "DATA downloading successful" displays after the save is performed; the system displays: "downloading fail" when the save is incorrect; the "illegal downloading parameter" displays without downloading conditions.

Note: It only can be saved and operated by pressing the **[Save]** key after modifying.

The search and positioning can be performed by the page-up, page-down and four direction keys on the panel; checking and modifying of the data list address can be performed.

3.4 Counter

Press the [CTR] soft key in the Fig. 3-1, then enter the checking and setting interface of the counter, refer to the Fig. 3-4-1.

PLCPARA					RUN
NO.	ADDR.	CURT.	SET.	REMARK	
000	C000	00000	00000	STANDBY	
001	C001	00000	00000	STANDBY	
002	C002	00000	00000	STANDBY	
003	C003	00000	00000	STANDBY	
004	C004	00000	00000	STANDBY	
005	C005	00000	00000	STANDBY	
006	C006	00000	00000	STANDBY	
007	C007	00000	00000	STANDBY	
008	C008	00000	00000	STANDBY	
009	C009	00000	00000	STANDBY	
010	C010	00000	00000	STANDBY	
011	C011	00000	00000	STANDBY	

DATA	^	09: 42: 53				
		PATH: 1 MDI				
	KPAR	TMR	DATA	CTR	RETURN	▶

Fig. 3-4-1

The content and operation of the counter:

- RUN** : The operation state of the ladder diagram.
- NO.** : Serial number of the counter; Do not change it.
- ADDR.** : Counter address; Do not change it.
- CURT** : Current value of the counter; Do not change it.
- SET** : Counter setting value; it can be changed after the K000.0 (PLC parameter allows modification) is set to 1 in the MDI mode.
- Input** : Input data display.
- MDI mode** : Current working mode.
- [Return]** : Return to the previous menu.
- [▶]** : Enter to the next page.

The set value can be downloaded to the CNC operation pressing the <Save> key after modifying. “CTR downloading successful” displays after the save is performed; the system displays: “downloading fail” when the save is incorrect; the “illegal downloading parameter” displays without downloading conditions.

Note: It only can be saved and operated by pressing the [Save] key after modifying

The search and positioning can be performed by the page-up, page-down and four direction keys on the panel; checking and modifying of the counter address can be performed.

3.5 M function corresponding to F address

Press the [▶] soft key in the Fig. 3-1 entering the next page; press the [MDEC] soft key entering the checking and setting interfaces of the M function corresponding to the F address, refer to the Fig. 3-5-1.

MCodeDEC		RUN	
MCODE	ADDR	REMARK	
M00	F031.7	Program Stop	
M01	F030.4	Optional Stop	
M02	F030.5	End of Program	
M03	F030.0	Spindle forward	
M04	F030.1	Spindle backward	
M05	F030.2	Spindle stop	
M06	F030.3	Auto change tool	
M07	F***.*	STANDEBY	
M08	F031.0	Coolant on	
M09	F031.1	Coolant off	
M10	F031.2	A axis Clamp	
M11	F031.3	A axis Release	

DATA		12:38:11
		PATH: 1 MDI
◀	MDEC	RETURN

Fig. 3-5-1

The content and operation of the M function corresponding to the F address:

MCodeDEC : It indicates MDEC interface.

RUN : The operation state of the ladder diagram.

MCODE : M function number.

ADDR. : F address setting; Input the password higher than the terminal user, which can be modified in the MDI mode; the system should be restarted again after modifying.

MEANING : M function explanation.

Input : Input data display

MDI mode : Current working mode.

[Return] : Return to the previous menu.

[◀] : Enter to the previous page.

This interface is used for registering and deleting of the M code. F signal is set to the one unique corresponding M code; the M code that does not set by the F signal is disabled.

The corresponding F strobe signal may be sent based upon this list when M code is performed,

then start the corresponding ladder diagram network. The system alarm occurs after modifying, the prompt content is “Cut off the power”, and its setting is enabled after the system is restarted. The setting of the M function in PLC program, its corresponding M code is desired to be used after the corresponding address is modified, the ladder diagram is then modified. It is necessary to operate carefully, so that the machine may be damaged or the injury accident may occur.

The search and positioning can be performed by the page-up, page-down and four direction keys on the panel; the M function corresponding to the F address can be checked or modified.

Note 1: M00, M03, M04 and M05 can not be changed because they are occupied by the system.

Note 2: The file numbers of the ladder diagram and configuration should be consistent when the system is performed the ladder and configuration files. The data after modifying are stored to the configuration file of corresponding current ladder diagram file number. User should compile its significance of the signal in this configuration file, so that the system can be correctly displayed the modified information from the user. The Chinese note name of the configuration is “LadChixx”, and the English note name is “LadEngxx”.

CHAPTER FOUR USER EXPLANATION OF LADDER DIAGRAM SOFTWARE EDIT

4.1 Brief

At present, the GSK218MC system supports the compilation software of the configured GSK ladder diagram.

The compilation software of the GSK ladder diagram is a ladder diagram editor on the PC machine of the GSK218MC and machine center CNC, which mainly offers the functions such as the edit, conversion, debugging and printing of the GSK218MC series ladder diagram. This software can be used in the Windows 98, Windows Me, Windows 2000, Windows XP and Windows 2003.

4.2 Software Introduction

4.2.1 Software Start

The compilation software of the GSK ladder diagram is a green one regardless of installing, which includes two files (Lad Edit. exe and Diag.me) and one folder (LadFile). The Ladder01 file in the LadFile folder is the standard ladder diagram of the system. The software can be operated by clicking Lad Edit. exe twice. When the Ladder01 ladder diagram in the LadFile folder is opened in the software, the interface is shown below:

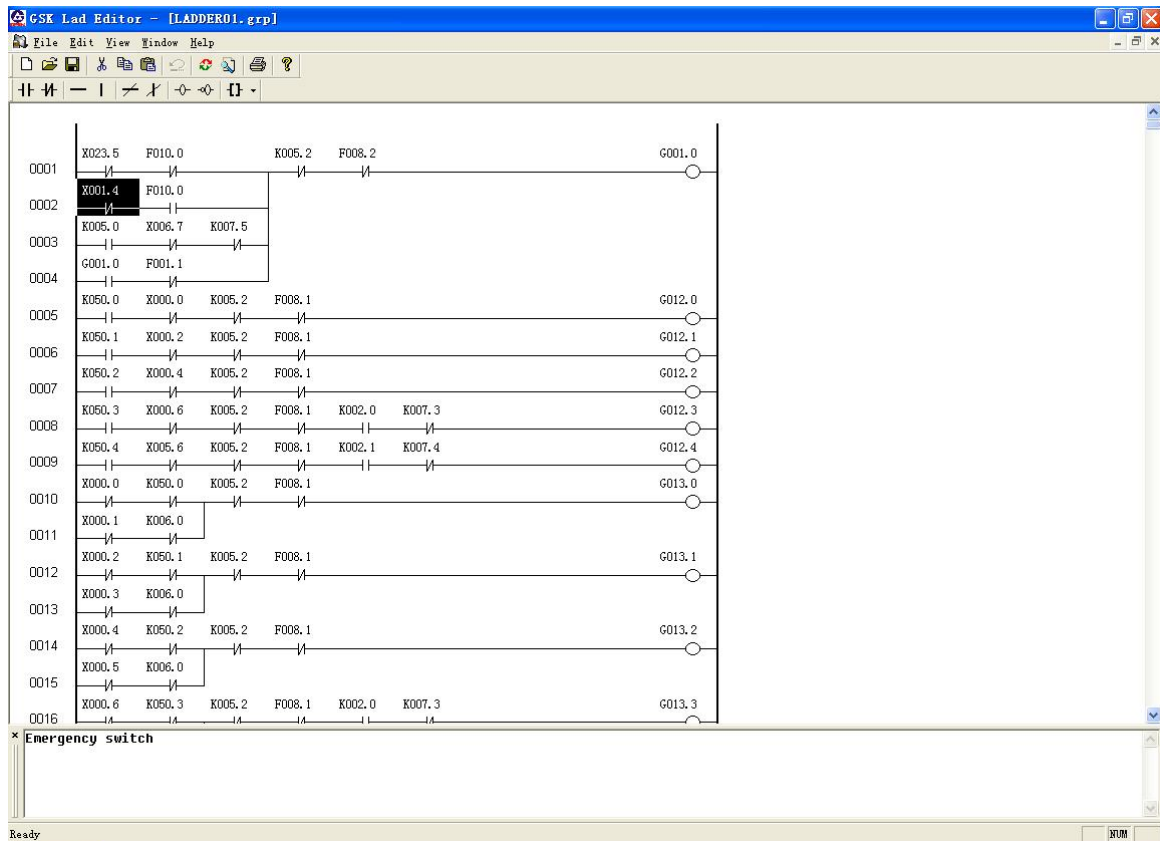

Fig. 4-2-1-1

4.2.2 Function Introduction

● File menu

The file menu includes some program files, namely, the new, open and save, which can be produced some functions, such as the performable ladder diagram file or binary system file, printing, printing preview and printing setup and the recently opened file list.

Note: In the “ladder diagram editing” dialog box, each volume of the “ladder diagram version number”, “suitable machine” and “ultimate modifier”, can be indicated by English, instead of Chinese, otherwise, the error may occur after transferring.

● Edit menu

The edit menu includes some functions such as the cutting, copy, pasting, searching, conversion and editing etc.

● View menu

Control the display and concealing of the toolbar, state bar, output and command list windows.

● Window menu

Control the selection and layout of each window.

● Help menu

Version information of this software











4.3 Software Operation

4.3.1 Toolbar

There are two toolbars of the main view frame, which are related with the ladder diagram compilation.





4.3.1.1 Main Toolbar



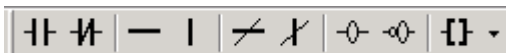



-  New ladder diagram file
-  Open the ladder diagram file
-  Save the ladder diagram file
-  Cut the selected content to the clipboard
-  Copy the selected content to the clipboard
-  Paste content from the clipboard
-  Ladder diagram conversion
-  Component search
-  Print the ladder
-  About the dialog box

4.3.1.2 Toolbar Editing



-  Insert the normally opened contact
-  Insert the normally closed contact
-  Insert the horizontal breakover line
-  Insert the vertical breakover line (place at the lower right corner of the cursor)
-  Delete single cell or horizontal breakover line

-  Delete the vertical breakover line at the lower right corner of the component
-  Insert the input coil
-  Insert the output coil reverse
-  Function code button: There are two methods in the Edit function code:

1. Spring the drawing menu pressing the mini arrow at the right once, and then select the function codes

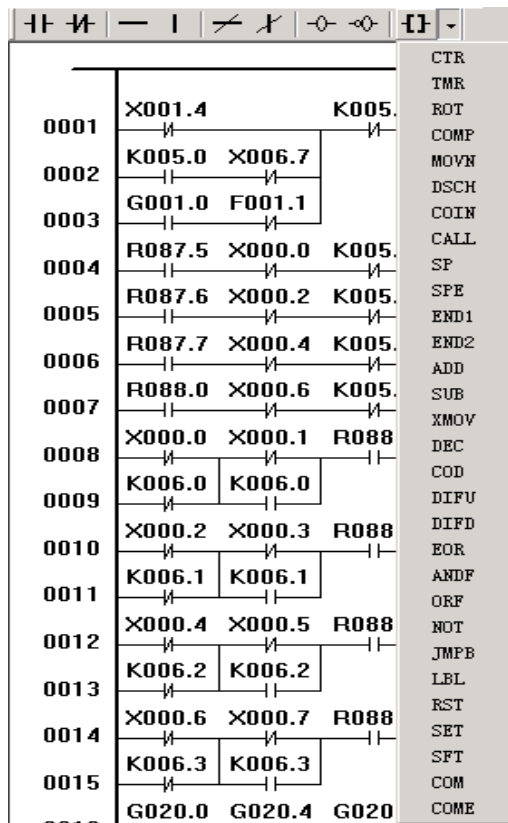

Fig. 4-3-1-2-1

2. Or, click the button icon, set the function code in the sprung function code selection dialog.

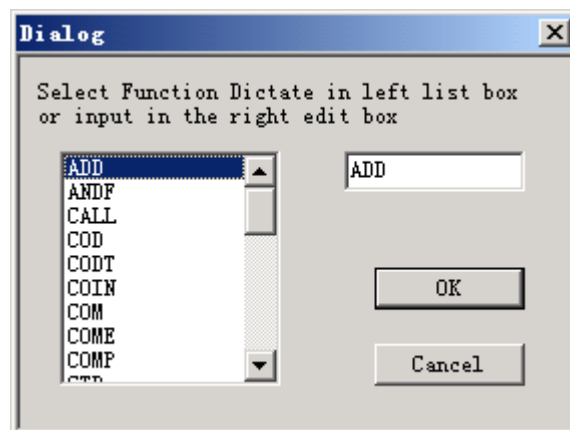

Fig. 4-3-1-2-2

4.3.2 Selection of Figure

In the editing view of the ladder diagram, the black rectangle shadow means cursor, click the left key of the mouse in the figure editing area between two bus cables, and select the position where the figure unit needs to be edited. Refer to the following figure.

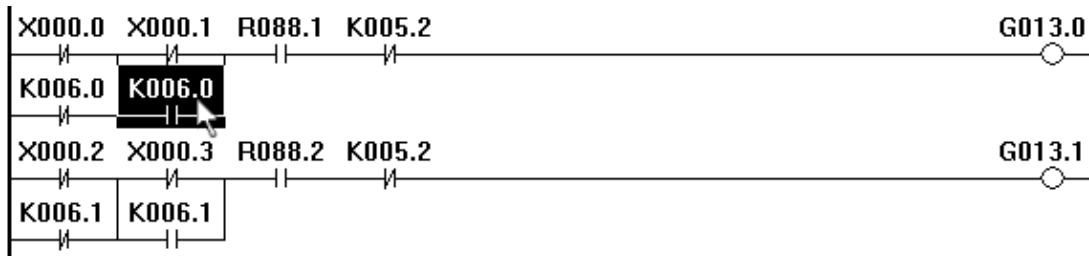

Fig. 4-3-2-1

When the block is selected, press the mouse left key at the beginning position of the block, then drag to the end. The selected area indicates by the rectangle with dotted line before releasing the left key.

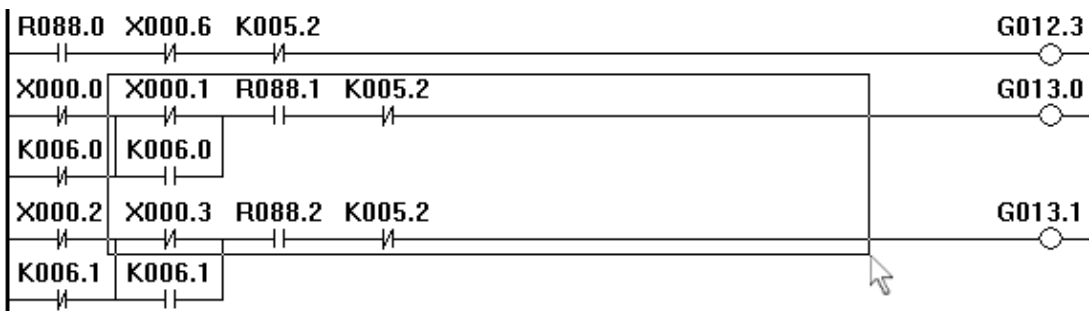

Fig. 4-3-2-2

The inverted color of the whole ladder diagram after releasing, that is, the ladder diagram within this range is selected, and the next operation can be performed. For example, cutting, deletion and copy etc.

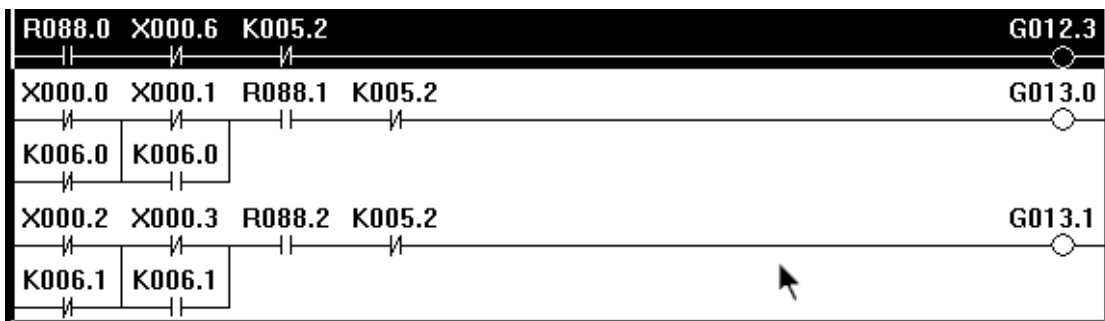

Fig. 4-3-2-3

4.3.3 Editing of Figure

4.3.3.1 Cutting

There are three ways for carrying out this operation after the ladder diagram area to be edited is selected:

1. Select the cutting after springing the environment menu by clicking the right key of the mouse;
2. Select the Edit [Alt+E]--- Cutting [T] of the main menu;
3. Shortcut key [Ctrl+X].

The cut content is placed to the clipboard, which is copied to the ladder diagram by the paste operation.

4.3.3.2 Copy

There are three ways for carrying out this operation after the ladder diagram area to be copied is selected:

1. Select the copy after springing out the environment menu by clicking the right key of the mouse;
2. Select the Edit [Alt+E]--- Copy [C] of the main menu;
3. Shortcut key [Ctrl+C].

The selected content after copying is put to the clipboard, which is copied to the ladder diagram by the paste operation.

4.3.3.3 Pasting

There are three ways for carrying out this operation after the ladder diagram area to be pasted is selected:

1. Select the pasting after springing out the environment menu by clicking the right key of the mouse;
2. Select the Edit [Alt+E]--- Pasting [P] of the main menu;
3. Shortcut key [Ctrl+V].

4.3.3.4 Deletion

There are three ways for carrying out this operation after the ladder diagram area to be deleted is selected:

1. Select the basis code ---- Deletion node after springing out the environment menu by clicking the right key of the mouse once;

2. Click the [Deletion node] button on the editing bar;
3. Shortcut key [Delete];

4.3.3.5 Line Insertion

There are three ways for carrying out this operation after moving the cursor to the position to be inserted the ladder diagram line:

1. Select the insert after springing out the environment menu by clicking the right key of the mouse;
2. Select the Edit [Alt+E]---Insertion line [I] of the main menu;
3. Shortcut key [Insert];

4.3.3.6 Line Deletion

There are three ways for carrying out this operation after moving the cursor to the position to be deleted the ladder diagram line:

1. Select the insert after springing out the environment menu by clicking the right key of the mouse;
2. Select the Edit [Alt+E]--- Deletion line [D] of the main menu;
3. Shortcut key [Ctrl+Delete];

4.3.3.7 Conversion

There are three ways for carrying out this operation after the ladder diagram of the current editing interface is converted into the command list program:

1. Select the Edit [Alt+E]--- Conversion [V] of the main menu;
2. Click once the [Ladder diagram conversion] button on the editing bar;
3. Shortcut key [F7];

4.3.4 Ladder Diagram Note

4.3.4.1 Line Note of Ladder Diagram

Click the left key of the mouse twice out of the bus area at the ladder diagram right; input the notes in the editing frame.

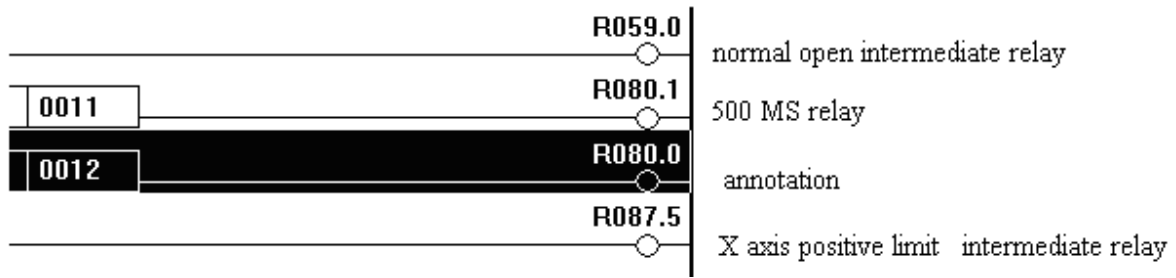

Fig. 4-3-4-1-1

4.3.4.2 Component Note of Ladder Diagram

There are two ways for carrying out this operation after moving the cursor to the position to be modified the ladder diagram component:

1. Click the right key of the mouse after the component is selected; select the modified notes [M] in the springing environment menu;

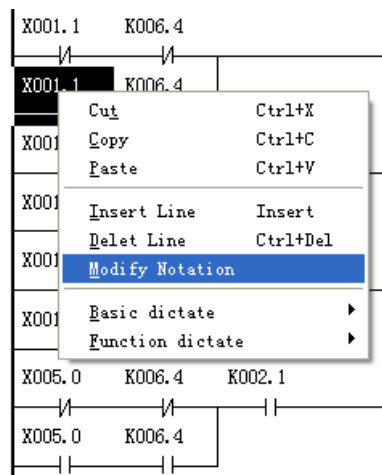

Fig. 4-3-4-2-1

2. Select the edit [Alt+E]----Note modification [M] of the main menu.

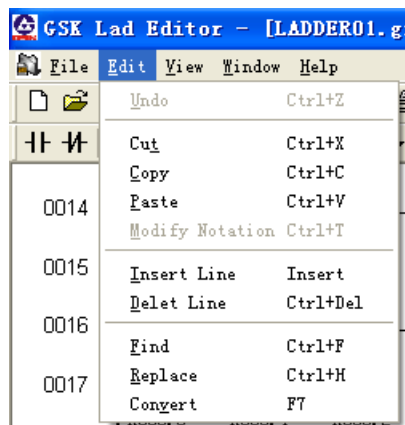

Fig. 4-3-4-2-2

3. Shortcut key [Ctrl+T].

Input the notes in the sprang dialog box; save it by clicking the OK button.

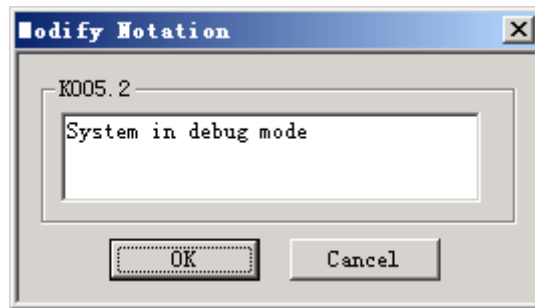

Fig. 4-3-4-2-3

The notes saved will be displayed the output window under the screen when the component is selected each time, refer to the following figure:

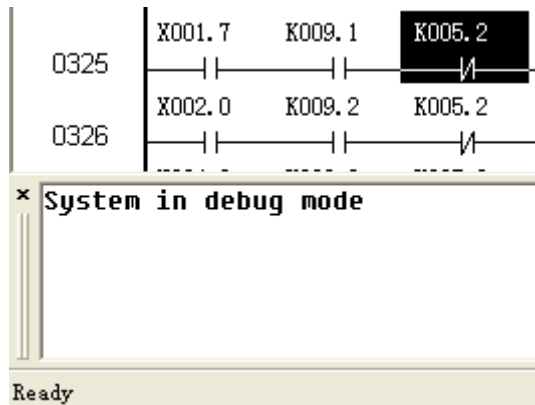

Fig. 4-3-4-2-4

4.3.5 Leading-out

The ladder diagram file should be converted when it is edited and saved, which can be generated the performable file after converting, and then transfer to the CNC using the serial-port communication software or U disk that it is performed by the PLC from the CNC system. Refer to the Chapter Eleven **System Communication** in the Volume Three of the **218MC Programming and Operation Manual**.

The ladder diagram file is then produced.

Select the file [Alt+F]----Ladder diagram file producing [L] of the main menu, save it after inputting the name and path, the ladder diagram file with the extension name “.grp” is produced, which can be used in Milling machine and machining center of the GSK218MC series.

The configuration format of the ladder diagram is shown in the Appendix Two.

VOLUME III FUNCTION EXPLANATION

CHAPTER ONE CONTROLLABLE AXIS

1.1 Output of Axis Movement

Brief The movement state of each axis can be output to the PLC.

Signal Axis movement signal

MV1~MV4 (F017#0~F017#4)

[Type] Signal output

[Function] These signals are indicated that one controllable axis is being moved.

MV1: The 1st axis is being moved.

MV2: The 2nd axis is being moved.

MV3: The 3rd axis is being moved.

MV4: The 4th axis is being moved.

MV5: The 5th axis is being moved.

[Condition output]

The signal turns into 1 in the following case:

- The corresponding axis has been moved.

The signal turns into 0 in the following case:

- The corresponding axis has been stopped.

The signal of the axis movement direction

MVD1~MVD4 (F019#0~F019#4)

[Type] Signal output

[Function] These signals are indicated as the movement direction of one controllable axis.

MVD1: The movement direction signal along with the 1st axis

MVD2: The movement direction signal along with the 2nd axis

MVD3: The movement direction signal along with the 3rd axis

MVD4: The movement direction signal along with the 4th axis

MVD5: The movement direction signal along with the 5th axis

[Condition output] “0” indicates the corresponding axis moves along with the negative direction, “1” indicates the corresponding axis moves along with the positive direction.

Note:

These signals are kept invariable during stopping, which indicates the axis movement direction before stopping.

Signal address

	#7	#6	#5	#4	#3	#2	#1	#0
F017				MV5	MV4	MV3	MV2	MV1
F019				MVD5	MVD4	MVD3	MVD2	MVD1

1.2 Servo Signal Ready

Signal Servo signal ready

SA (F000#6)

[Type] Signal output

[Function] SA signal turns into 1 after the servo is ready. As for the axis that with brake, the brake is released when the signal is outputted. It is braked when this signal does not output.

Signal address

	#7	#6	#5	#4	#3	#2	#1	#0
F000		SA						

CHAPTER TWO OPERATION PREPARATION

2.1 ESP

Brief: The machine immediately stops by pressing the ESP button on the operation panel of the machine tool.

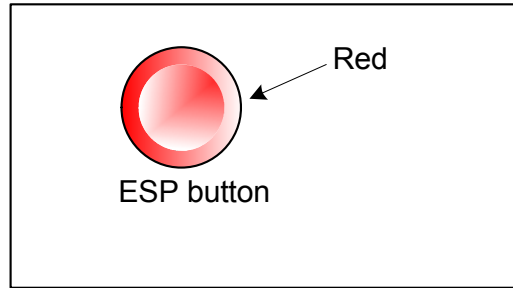

Fig. 2-1

The button is locked after pressing; the releasing methods are differing from the manufactures. Usually, the button can be released by left-rotation.

Signal ESP Signal

ESP (G001.0)

[Type] Signal input

[Function] The machine immediately stops after inputting the ESP signal.

[Purpose] When the ESP turns into 1, CNC is reset, and then the machine is on the ESP state.

Signal address

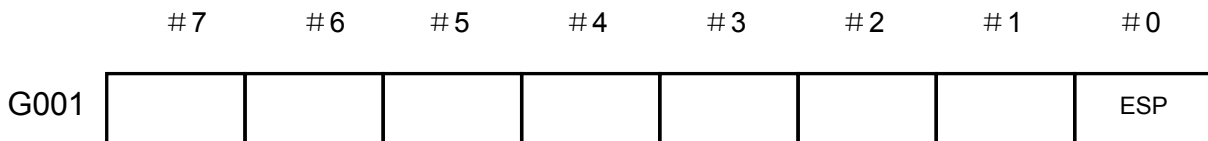

2.2 CNC Overtravel Signal

Brief: The limit switch operates, and the tool decelerates and stops when the tool movement exceeds the stroke end set by the machine tool limit switch, the overtravel alarm is then displayed.

Signal Overtravel signal

+L1~+L5 (G012#0~G012#4)

—L1~—L5 (G013#0~G013#4)

[Type] Signal input

[Function] It indicates the controllable axis has been reached to the stroke limit. Each direction of each controllable axis has this signal. The “+” and “-“ are expressed the direction of the signal name, the digit is corresponding with the controllable axis.

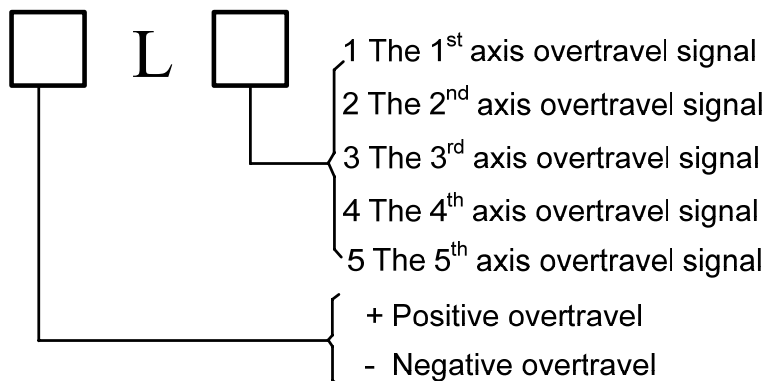

[Motion] When the signal is “0”, the operations of the controllable units are shown below:

- * All of the axes are decelerated in the automatic operation, even if only the overtravel signal of one axis turns into 1, the alarm occurs and stops.
- * The axis with movement signal 1 is decelerated and stopped in the manual operation, the axis after stopping can be moved along with the negative direction.
- * The movement direction is being stored once the axis overtravel signal becomes 1. Before the alarm clear, this axis can not be performed along with this direction even if the signal turns into 0.

Signal address

	#7	#6	#5	#4	#3	#2	#1	#0
G012				+L5	+L4	+L3	+L2	+L1
G013				-L5	-L4	-L3	-L2	-L1

2.3 Alarm Signal

Brief: When the alarm occurs in the CNC, which displays on the screen, and its alarm signal is set to 1.

Signal Alarm signal

AL (F001#0)

[Type] Signal output

[Function] The alarm signal indicates that the following alarms are displayed when the

CNC is in the alarm state:

- a) P/S alarm
- b) Overtravel alarm
- c) Servo alarm

[Condition output] The alarm signal is 1 in the following conditions:

—— CNC is in the alarm state

The alarm signal is 0 in the following situation:

—— Clear the alarm by the CNC resetting

Signal address

	#7	#6	#5	#4	#3	#2	#1	#0
F001								AL

2.4 Selection of Operation Method

Signal Detection signal in the operation method

F003#0~F003#7

[Type] Signal output

[Function] It indicates the currently selected operation method.

Signal address

	#7	#6	#5	#4	#3	#2	#1	#0
F003	MZRO	MEDT	MMEM	MRMT	MMDI	MJ	MH	MINC

2.5 State Signal Output

Cutting feed signal

CUT (F002#6)

[Type] Signal output

[Function] This signal indicates that it is being performed the automatic cutting feed.

[Condition output] The signal is set to 1 in the following conditions:

In the automatic cutting feed (linear interpolation, arc interpolation, helical interpolation, thread cutting, skip cutting or cutting in the canned cycle)

Notice:

1. This signal does not output when the feed is in the dwell state.
2. This signal can be outputted during interlocking or the federate is 0.

Signal address

	#7	#6	#5	#4	#3	#2	#1	#0
F002		CUT						

CHAPTER THREE MANUAL OPERATION

3.1 JOG Feed/Incremental Feed

Brief

JOG feed The feed axis and direction selection signal on the operation panel is set to 1 in the JOG mode. The machine is consecutively moved along the selected axis in its direction.

Incremental feed The feed axis and direction selection signal on the operation panel is set to 1 in the incremental feed mode. The machine moves one step along the selected axis in its direction; the least distance of the machine movement is the least input increment, each step has the least input increment with 10, 100 or 1000 folds.

JOG feed and incremental feed are absolutely same, other than the feed distance selection method. In JOG feed, the machine can be consecutively feed when the feed axis (+J1, -J1, +J2, -J2, +J3 and -J3) and direction selection signal are set to 1. In incremental feed, the machine is single step feed. The JOG feedrate can be adjusted by its override disk.

The machine moves based upon the rapid feedrate by the rapid feed selection switch; however, it is regardless of the JOG feed velocity override signal.

The single-step distance can be selected by the incremental step **G026 # 0~G026 # 3**.

Signal Feed axis and direction selection

+J1~+J4 (G27 # 0~G27 # 3)

-J1~-J4 (G28 # 0~G28 # 3)

[Type] Input signal

[Function] Select the required feed axis and direction in the JOG feed or incremental feed. The "+" and "-" in the signal name are indicated as feed direction, the digit is corresponding with the controllable axis.

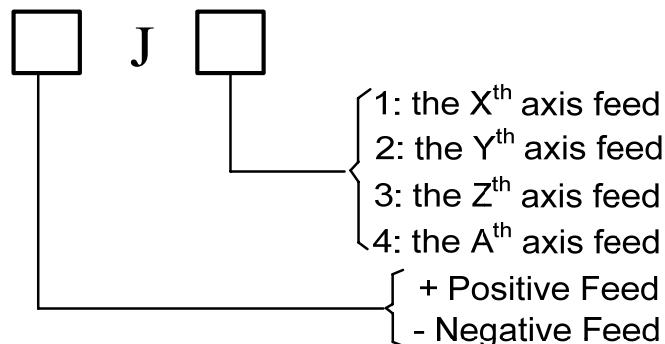

[Motion] When the signal is set to 1, the controllable unit is shown below:

- * The controllable unit can be moved the specified axis along the specified direction when the JOG feed or incremental feed is enabled.

In JOG feed, the controllable unit consecutively moves the controllable axis when the signal is set to 1.

- * In the incremental feed, the controllable unit makes that the specified axis feeds based upon the specified step distance, and then it stops. The controllable unit may not stop feeding even if this signal is set to 0 during the axis feed. Move the axis again, and the signal will be set to 0 then to 1.

Manual rapid feed selection signal

RT (G024#7)

[Type] Signal input

[Function] Select the rapid traverse rate of the JOG feed or increment feed.

[Purpose] When the signal turns into 1, the operation of the controllable unit is shown below:

- The controllable unit performs the JOG feed or increment feed at the rapid traverse rate. The rapid traverse override is enabled.
- The signal shifts to 0 from 1 or is reverse, and its feedrate decreases to 0 during the JOG feed or increment feed. The feed axis and the direction selection signal can be kept to 1 during the acceleration or deceleration.

Signal address

	#7	#6	#5	#4	#3	#2	#1	#0
G024	RT							
G027					+J4	+J3	+J2	+J1
G028					-J4	-J3	-J2	-J1

3.2 MPG/Single Step Feed

Brief In the MPG/single step feed mode, the machine tool can be slightly moved by rotating the MPG or single-stop operation. The machine tool movement axis can be selected by the MPG feed axis signal or axis movement signal.

Signal **MPG/Single-step feed amount selection signal**
(G026#4~G026#5)

[Type] Signal input

[Function] MPG/Single-step feed traverse amount selection signal

This signal is performed the binary encoding by two G signals which means the movement distance of each step.

MPG/Single-step amount selection signal		MPG		Single-step	
MP1	MP2	mm	inch	mm	inch
0	0	0.001	0.0001	0.001	0.0001
1	0	0.01	0.001	0.01	0.001
0	1	0.1	0.01	0.1	0.01
1	1	0.1	0.01	1	0.1

CHAPTER FOUR REFERENCE POSITION RETURN

4.1 Manual Reference Position Return

Brief The machine tool moves along with the specified direction and returns to the reference position by setting the parameter N0: 7#0~#4 in the mode of the manual reference position return. The selected axis from the panel button is only indicated the one of the specified zero return and it is regardless of the axis move.

The following signals are related with the manual reference position return:

Table 4-1-1

	Manual reference position return
Deceleration signal of reference position return	DECX, DECY, DECZ, DEC4, DEC5
End signal of reference position return	ZP1, ZP2, ZP3, ZP4, ZP5

Signal

End signal of reference position return

ZP1~ZP5(F016#0~F016#4)

[Type] Signal output

[Function] This signal shows that the machine tool has been held in the reference position of the controllable axis.

These signals are one-to-one corresponding with the axes.

Table 4-1-2

ZP1	The 1 st axis returns to the zero end signal
ZP2	The 2 nd axis returns to the zero end signal
ZP3	The 3 rd axis returns to the zero end signal
ZP4	The 4 th axis returns to the zero end signal
ZP5	The 5 th axis returns to the zero end signal

[Condition output] When the signal becomes 1:

- The manual reference position return has been completed, and its current position is located on the in-position area.
- The automatic reference position return (G28) has been completed, and its current position is located on the in-position area.
- The detection of the reference position return has been completed, and its current position is located on the in-position area.

When the signal becomes 0:

- When the machine tool moves from the reference position.
- When the ESP signal occurs
- When the servo alarm generates.

Return to the zero deceleration signal detection

DECX (G017 # 0) DECY (G017 # 1) DECZ (G017#2) DEC4 (G017#3) DEC5(G017#4)

[Type] Signal input

[Function] These signal decreases the move speed of the manual reference position return, so that it approximates to the reference position at the low speed.

4.2 Return to Reference Position Detection Signal

The detection allowance signal of the 1st reference position

PREF10---PREF13 (G056#0---#4)

The detection allowance signal of the 2nd reference position

PREF20---PREF23 (G057#0---#4)

The detection allowance signal of the 3rd reference position

PREF30---PREF33 (G058#0---#4)

PREF40---PREF43 (G059#0---#4)

The detection allowance signal of the 4th reference position

[Type] Signal input

[Function] When this signal is set to 1, the end signal (F42, F43 and F44) of the reference position return is enabled.

These signals are one-to-one corresponding with the axes.

Table 4-2-1

PREF*0	Inspection permission signal of the 1 st axis reference position
PREF*1	Inspection permission signal of the 2 nd axis reference position
PREF*2	Inspection permission signal of the 3 rd axis reference position
PREF*3	Inspection permission signal of the 4 th axis reference position
PREF*4	Inspection permission signal of the 5 th axis reference position

End signal of the 1st reference position return

ZP11---ZP15 (F041#0---#4)

End signal of the 2nd reference position return

ZP21---ZP25 (F042#0---#4)

End signal of the 3rd reference position return

ZP31---ZP35 (F043#0---#4)

End signal of the 4th reference position return**ZP41---ZP45 (F044#0---#4)****[Type]** Signal output**[Function]** This signal shows that the machine tool has been held in the reference position of the controllable axis.

These signals are one-to-one corresponding with the axes.

Table 4-2-2

ZP*1	End signal of the 1 st axis reference position return
ZP*2	End signal of the 2 nd axis reference position return
ZP*3	End signal of the 3 rd axis reference position return
ZP*4	End signal of the 4 th axis reference position return
ZP*5	End signal of the 5 th axis reference position return

[Condition output]

This signal is enabled when the detection allowance signal (G57, G58 and G59) of the reference position is set to 1. The signal becomes 1 when the following states are displayed.

- The manual reference position return has been completed, and its current position is located on the in-position area.
- The automatic reference position return (G30) has been completed, and its current position is located on the in-position area
- The detection of the reference position return has been completed, and its current position is located on the in-position area.

The signal becomes 0 when the following states are displayed:

- The detection permission signal (G57, G58 and G59) of the reference position is set to 0
- The machine tool moves from the reference position.
- The ESP signal occurs
- The servo alarm generates.

4.3 Area Detection Signal**Area detection signal****AQ1—AQ3 (F045#0---#2)****[Type]** Signal output**[Function]** This signal shows that the machine tool has been held in the area range of the controllable axis

These signals are one-to-one corresponding with the axes.

Table 4-3-1

AQ1	Area detection signal of the 2 nd reference position along with Z axis
AQ2	Area detection signal of the 3 rd reference position along with Z axis
AQ3	Area detection signal of the 4 th reference position along with Z axis

[Condition output]

When the machine tool position is within the area of the stored stroke check 1 (Data parameter **P66~P75** is set the boundary), and without the area of the stored stroke check 2 (Data parameter **P76~P85** or program code can be set this boundary), the signal is then turned into 1; otherwise, it turns into 0.

Signal address

	#7	#6	#5	#4	#3	#2	#1	#0
F016				ZP5	ZP4	ZP3	ZP2	ZP1
F041				ZP15	ZP14	ZP13	ZP12	ZP11
F042				ZP25	ZP24	ZP23	ZP22	ZP21
F043				ZP35	ZP34	ZP33	ZP32	ZP31
F044				ZP45	ZP44	ZP43	ZP42	ZP41
F045						AQ3	AQ2	AQ1
G017				DEC5	DEC4	DECZ	DECY	DECX
G057				PREF24	PREF23	PREF22	PREF21	PREF20
G058				PREF34	PREF33	PREF32	PREF31	PREF30
G059				PREF44	PREF43	PREF42	PREF41	PREF40

CHAPTER FIVE AUTOMATICAL OPERATION

5.1 Cycle Start/ Feed Dwell

Brief

Start the automatic operation (Cycle start): In the storage mode, the automatic operation start signal ST is set to 1 during the DNC or MDI mode; the CNC enters into the automatic operation start state, then operates.

Signal ST is ignored in the following conditions:

1. Except the automation, DNC and MDI method.
2. When the feed dwell signal (SP) is set to 1.
3. When the ESP signal (ESP) is set to 1.
4. Press the <RESET> button on the MDI.
9. CNC is on the alarm state.
10. The automatic operation has been started already.
11. When the program restart signal (SRN) is set to 1.
12. CNC is searching a sequence number.

In the automatic operation, the CNC enters into the feed hold state and stops in the following states:

1. When the feed dwell signal (SP) is set to 1.
2. Single block code is ended during the single block operates.
3. MDI operation has been completed.
4. The alarm occurs in the CNC.
5. The single block code has been completed after it becomes the other automatic operations or edit mode.

In the automatic operation, the CNC enters into the reset state and stops in the following states.

1. The ESP signal (ESP) is set to 1.
2. Press the <RESET> button on the MDI.

Automatic operation interrupted (Feed dwell)

The feed dwell signal SP is set to 1 during the automatic operation, the CNC enters into the dwell state and stops. At the same time, the cycle start indicator STL is cleared to 0, and the feed hold indicator SPL is set to 1. The automatic operation will not restart even if the SP signal is cleared to 0 again. If the restart automatic operation should be performed again, the SP signal firstly should be cleared to 0, and then set the ST signal to 1, and then clears to 0 lastly.

Signal Cycle start signal**ST (G023#6)****[Type]** Signal input**[Function]** Start the automatic operation**[Motion]** ST is set to 1 in DNC or MDI mode during the automatic operation, the CNC then enters into the cycle start state and starts to operate.**Feed dwell signal****SP (G023#7)****[Type]** Signal input**[Function]** Automatic operation interruption**[Operation]** SP signal is set to 1, and CNC enters into the feed dwell state and stops during the automatic operation. When the SP signal is set to 0, the automatic operation can not be started.**Cycle start indicator signal****STL (F000#5)****[Type]** Signal output**[Function]** Notify the PLC that has been entered into the automatic operation start.**[Condition output]** The signal can be set to 1 or 0, which is determined by CNC state, refer to the Fig. 5.1.**Feed dwell indicator signal****SPL (F000#4)****[Type]** Signal output**[Function]** Notify the PLC that has been entered into the feed dwell state.**[Condition output]** The signal can be set to 1 or 0, which is determined by CNC state, refer to the Fig. 5.1.**Automatic operation signal****OP (F000#7)****[Type]** Signal output**[Function]** That notify the PLC automatic operation is being performed.**[Condition output]** This signal can be set to 1 or 0, which is determined by CNC state, refer to the Fig. 5.1.

Table 5-1

	Cycle start LED STL	Feed dwell LED SPL	Auto-operation LED OP
Cycle start state	1	0	1
Feed dwell state	0	1	1
Auto operation stop state	0	0	0
Resetting state	0	0	0

Signal address

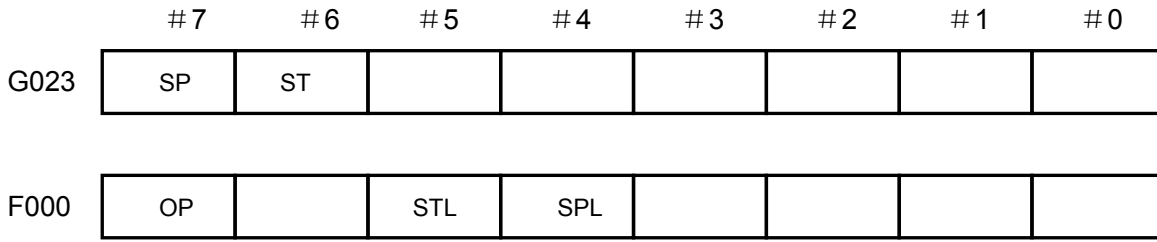

5.2 Resetting

Brief: The CNC is reset and entered into the reset state in the following conditions:

1. The ESP signal is set to 1.
2. Press the <RESET> key on MDI

The reset signal RST outputs to PLC when CNC is reset. After the above-mentioned conditions are released, the reset signal RST is set to 0 when it outputs the time set by parameter No.203.

$$RST = T_{reset} (\text{Resetting treatment time}) + \text{the setting value of the parameter No.203}$$

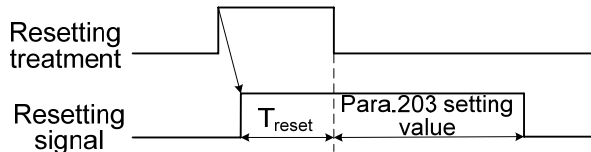

Fig. 5-2

In the automatic operation, the automatic operation stops when CNC is reset, and the operation axis decelerates then stops.

The CNC is reset during performing the M, S, T function, the MF, SF and TF signals are set to 0 within 16ms.

RST (F001 #1)

[Type] Signal output

[Function] PLC and CNC is already reset, this signal is used for treating the PLC reset.

[Condition output] This signal is set to 1 based upon the following conditions:

1. ESP signal is set to 1.
2. Press the <RESET> key on MDI.

This signal is set to 0 in the following case:

After the abovementioned conditions are released, and then the CNC is reset. The reset signal output time set by parameter No.203 has been ended.

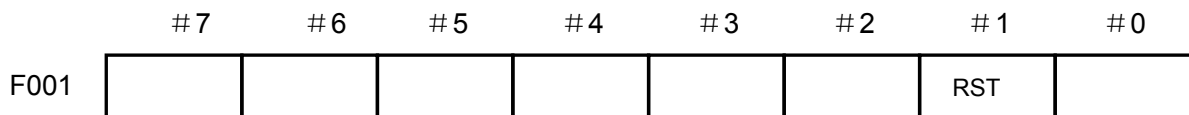
Signal address**5.3 Program Testing**

Brief: The automatic operation detection should be firstly performed before machining, which is tested whether the generated program is correct. When the machine does not operate, the detection is performed by the change viewing the position display or the actual operation machine tool.

5.3.1 Machine Tool Lock

Brief Do not move the change of the machine tool monitoring position display.

When all axes of the machine tool lock signal MMLK is set to 1, stop to output pulse to the servo motor during manual or Auto operation, but the code distribution is still performed, and the absolute and relative coordinates are also renovated. So, the operator can check whether the code compilation is correct viewing the change of the monitor position.

The machine tool lock detection signal of all axes**MMLK (F004#1)**

[Type] Signal output

[Function] The machine lock signal state of all axes of the PLC

[Condition output] When the signal is set to 1, the machine tool lock signal of all axes is set to 1.

When the signal is set to 0, the machine tool lock signal of all axes is set to 0.

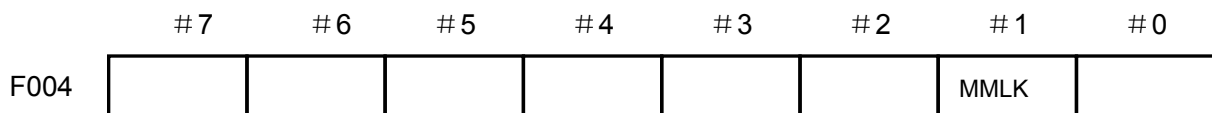
Signal address**5.3.2 Dry Run**

Brief The dry run is only enabled to the automatic operation. The machine operates with the constant feedrate instead of performing the one defined in the program. The feedrate is set by data parameter P86.

This function is used for checking the move of the machine tool when the machine tool does not install the workpiece.

Signal Dry run signal

DRN (G021 #2)

[Type] Signal input

[Function] Dry run enables.

[Motion] when this signal is set to 1, the machine tool moves based upon feedrate set by dry run.

The machine tool moves normally when the signal is set to 0.

Notice:

The dry run signal becomes 1 from 0 during the machine operation, and the machine tool operation speed is the one of the dry run, which is accelerated or decelerated by programming specified speed; when the dry run signal becomes 0 from 1, the machine tool operation speed is accelerated or decelerated to the programming specified speed by the dry run speed.

Signal address

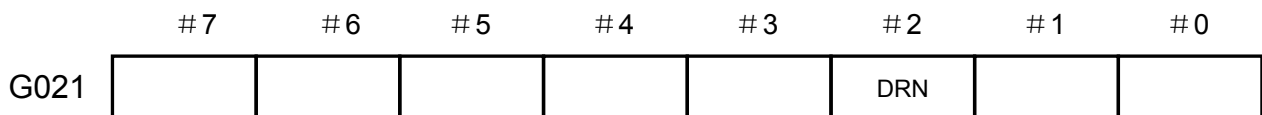

5.3.3 Single Block

Brief The signal block operation is only enabled to the automatic operation.

When the single block signal (SBK) is set to 1 during the automatic operation; the CNC enters into the automatic operation and stops after the current block is executed. In the sequence automatic operation, the CNC enters into the automatic operation and stops after each block in the program is performed. The automatic operation is performed again when the single block signal (SBK) is set to 0.

Signal Single block signal

SBK (G021 #1)

[Type] Signal input

[Function] Single block enables.

[Motion] Perform the single block operation when this signal is set to 1.

Perform the normal operation when this signal is set to 0.

Single block detection signal

MSBK (F004 #3)

[Type] Signal output

[Function] PLC single block signal state

[Motion] The signal is set to 1 in the following condition:
 —— When the single block signal SBK is set to 1.
 The signal is set to 0 in the following condition:
 —— When the single block signal SBK is set to 0.

Notice:

1. The operation in the thread cutting
 The SBK signal becomes 1 during the thread cutting, the operation is stopped after the thread cutting code is performed before the 1st non-thread cutting block.
2. The operation in the canned cycle
 The SBK (when it is set to 1) signal is stopped during the canned cycle instead of the EOB when the positioning approaches to the drilling and tool-retraction each time. SPL signal becomes 1 when it is set to 0, which means that it is not performed to the EOB. STL and SPL signals are became 0 and stopped when a block is performed.

Signal address

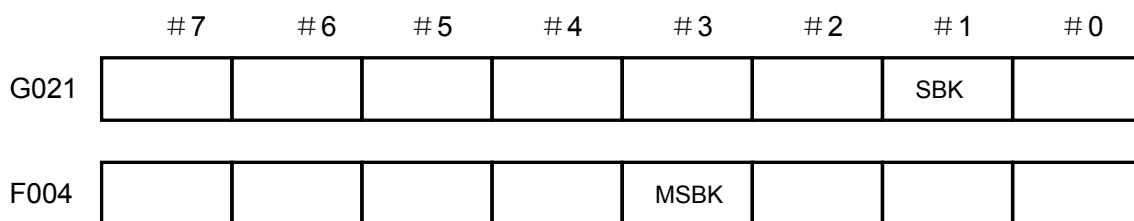

5.4 Skip Optional Block

Brief In the Auto operation, when a slash is specified at the beginning of the block, and when the skip optional block signal BDT is set to 1, this block is then ignored.

Signal Skip to the optional block signal

BDT (G021#0)

[Type] Signal input

[Function] Select whether the block with “/” is ignored.

[Motion] In the Auto operation, the block with “/” is ignored when BDT is set to 1; the program is performed normally when BDT is set to 0.

Skip the optional block detection signal

MBDT (F004#0)

[Type] Signal output

[Function] The state of PLC skip optional block BDT

Signal address

	#7	#6	#5	#4	#3	#2	#1	#0
G021								BDT
F004								MBDT

5.5 Program Restart

Brief The program can be restarted the block from the specified sequence number, after the tool damage or reset is being stopped. This function also can be used for the rapid program detection function.

Signal The signal of program restart

SRN<G021#6>

[Type] Signal input

[Function] Selection program restarts

[Motion] When the program restart signal is set to “1” for searching the sequence number of the restart block; the CRT screen shifts to the program restart screen. When the program restart signal is set to “0”, and the automatic operation is enabled, the machine tool moves to the machining restart point with the dry run speed in turn based upon the setting of the axis sequence. The machining restarts after the machine tool moves to the restart point.

The signal in the program restart

SRNMV<F002#4>

[Type] Signal output

[Function] It means that the program is being started.

[Condition output] When this signal becomes 1:

- When the G21 #6 is set to 1 in the Auto state, the program restart signal is set to 1.

When this signal becomes 0:

- End of the program restart sequence (all of the controllable axes from the machine are moved to the restart point)

Signal address

	#7	#6	#5	#4	#3	#2	#1	#0
G021		SNR						
F002				SRNM				

CHAPTER SIX FEEDRATE CONTROL

6.1 Rapid Traverse Rate

Brief 4-gear override (F0, 25%, 50% and 100%) can be used for the rapid traverse rate.

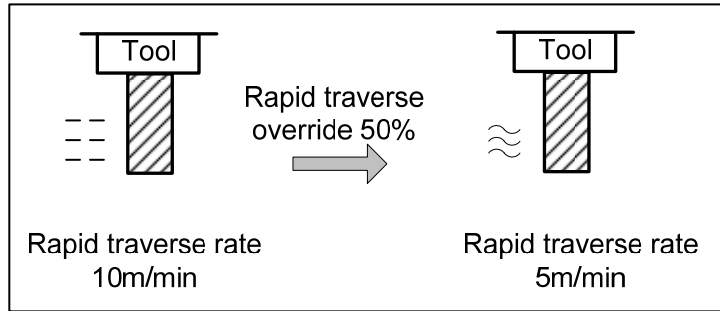

Fig. 6-1

Feedrate: The actual move speed is gained from which the setting value of the parameter P088~092 multiplies the override value, regardless in the Auto or manual operation (it consists of the manual reference position return and program zero return).

F0 speed It is determined by parameter P093.

Signal The code signal of the rapid traverse rate (G11#0~G11#1)

[Type] Signal input

[Function] It is the code detection signal of the rapid traverse override.

[Motion] The code signal corresponding with the following override

Code signal at the rapid traverse rate		Override value
RV1	RV2	
1	1	100%
0	1	50%
1	0	25%
0	0	F0

*The velocity of the F0 can be set by parameter (Data parameter P93).

6.2 Feedrate Override

Brief The override disk can be selected to increase or decrease the programming feedrate by the percentage. This character is used for the programming detection. For example, when the

specified feedrate in the program is 100mm/min, the override is set to 50%, the machine is then moves at the speed of 50mm/min.

Signal Code detection signal of feedrate override (G011#3~G011#7)

[Type] Signal input

[Function] There are 5 binary system code signals are corresponding to the override for the cutting feedrate override signal:

So, the override can be selected based upon the unit of the 10% within the range of the 0~200%.

Note: The feedrate both 218MC-H and 218MC-V are controlled by the feed brand switch.

6.3 Override Cancellation

Brief The feedrate override is fixed on 100% by the override cancellation signal.

Signal Override cancellation signal

OVC (G024#1)

[Type] Signal input

[Function] The feedrate override is fixed on 100%.

[Motion] The CNC operation is shown below when the signal is set to 1:

- The feedrate override is fixed on 100% regardless of the feedrate override signal.
- No affection in the rapid traverse override and spindle speed override.

Signal address

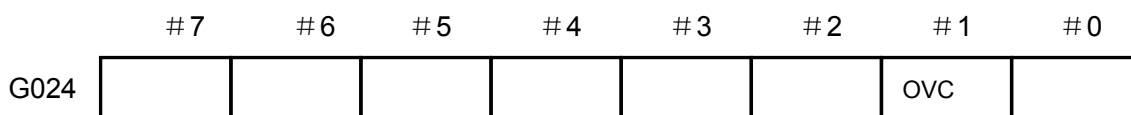

CHAPTER SEVEN MISCELLANEOUS FUNCTION

7.1 M Code Miscellaneous Function

Brief M code miscellaneous function When the registered M code is operated, the register signal (F026.0~F033.7) and the strobe signal are sent to the PLC, PLC is started or cut off its relative

Basis processing

These signals are used for the following functions:

Table 7-1-1

Function	Program address	Signal output		Response signal	End signal
		Register signal	Strobe signal		
M code miscellaneous function	M**	M** (F026#0~F033#7)	MF (F007 # 0)	MRESP (G063#0)	FIN(G000#0) MFIN(G000#1)

(1) It is supposed that the MXX is specified in the program (Suppose the register signal is FYYY.Y)

As for the MXX, if the user does not register it, the alarm may occur. User specifies a unique F signal registering this M code to the system, that is, the code signal from F26 to F33.

(2) If the non M, S and T codes, such as the movement and dwell, are specified with the miscellaneous function at the same time, the miscellaneous function is then simultaneously performed. Multiple codes of the miscellaneous function are specified in a block, its codes may perform in sequence.

(3) When the MXX is performed, the register signal FYY.Y and the strobe signal F007#0 are set to 1, simultaneously, ensuring the PLC sets the response signal RESP(G063#0) to 0.

(4) PLC is set the end signal MFIN (G000#1) and FIN (G000#0) to 1 when the operation is performed. If these functions, namely, the M, S and T code miscellaneous functions are performed simultaneously, the end signal FIN(G000#0) can be set to 1 till all of these functions are executed.

(5) When the MXX is completed, ensuring the PLC is set the response signal MRESP (G63#0) to 1.

(6) M, S and T codes may be performed simultaneously in a block. The CNC can be performed next block after affirming the end signal FIN is set to 1.

7.2 S Code Miscellaneous Function

Brief When the S code is performed, the I/O point or analog value control can be set by the bit 2 of the bit parameter No: 1

The basis processing of the spindle S code I/O point control:

Table 7-2-1

Function	Program address	Signal output		Response signal	End signal
		F address signal	Strobe signal		
S code miscellaneous function	S*	S* (F22)	TF (F007#2)	SRESP (G63#1)	FIN(G00#0) SFIN(G00#4)

S code miscellaneous function explanations are shown below:

(1) It is supposed that SX is specified in the program:

The range of the X is 1~8, the system may alarm if it exceeds its range. S1~S8 separately corresponds to the F address signal F22#0~#7. (For example, S1 corresponds to the F address signal F22#0).

- (2) If the non M, S and T codes, such as the movement and dwell, are specified with the miscellaneous function at the same time, the miscellaneous function is then simultaneously performed.
- (3) When the S1 is performed, the F address signal F22#1 and the strobe signal F007#2 are set to 1, simultaneously, ensuring the PLC sets the response signal RESP(G063#1) to 0.
- (4) PLC is set the end signal SFIN (G00#4) and FIN (G00#0) to 1 when the operation is performed. If these code miscellaneous functions, namely, M, S and T, are performed simultaneously, the end signal FIN (G00#0) can be set to 1 till all of these functions are executed.
- (5) When the S1 is completed, ensuring the PLC is set the response signal SRESP (G63#1) to 1.
- (6) M, S and T codes may be performed simultaneously in a block. The CNC can be performed next block after affirming the end signal FIN is set to 1.

The basic processing of the spindle S code analog value:

Table 7-2-1

Function	Program address	Signal output		The signal completion of the shifting	Response signal	End signal
		F address signal	Strobe signal			
S code miscellaneous function	S****	(F034#0~#2)	TF (F007 # 2)	GRAR (G002#4)	SRESP (G063#1)	FIN(G000#0) SFIN(G000#4)

The S code miscellaneous function explanations are shown below:

- (1) It is supposed that the SXXXX is specified in program: (The state of F34#0~#2 is determined by parameter P246~248, and PLC can be performed the processing of the gear step change by this signal, for example, the parameter P246 is set to 1000, and S500 executes).
- (2) If the non M, S and T codes, such as the movement and dwell, are specified with the miscellaneous function at the same time, the miscellaneous function is then simultaneously performed.
- (3) When the S500 is performed, the F address signal F34#0 and the strobe signal F007#2 are set to 1, simultaneously, ensuring the PLC sets the response signal SRESP(G063#1) to 0
- (4) The PLC is set the gear shift signal GRAR (G002#4) is set to 1 when the gear shift is completed.
- (5) PLC is set the end signal SFIN (G000#4) and FIN (G000#0) to 1 when the S code miscellaneous function is performed. If these code miscellaneous functions, namely, M, S and T, are performed simultaneously, the end signal FIN (G000#0) can be set to 1 till all of these functions are executed.
- (6) When the S500 is completed, ensuring the PLC is set the response signal SRESP (G063#1) to 1.
- (7) M, S and T codes may be performed simultaneously in a block. The CNC can be performed next block after affirming the end signal FIN is set to 1.

7.3 T Code Miscellaneous Function

Brief T code miscellaneous function: T code should be used with the M code together, for example:T06M06;

When the T code is performed, the data address (D241) and the strobe signal are sent to PLC, and PLC starts or cut off its relative functions using these signals.

Basis process

These signals are used for the following functions

Table 7-3-1

Function	Program address	Signal output		Response signal	End signal
		Data address	Strobe signal		
T code miscellaneous function	T**	T** (D241)	BF (F007 # 3)	SRESP (G63#2)	FIN(G00#0) TFIN(G00#5)

- (1) It is supposed that the TXX (XX is sent to the data address D241) is specified in the program:
- (2) If the non M, S and T codes, such as the movement and dwell, are specified with the miscellaneous function at the same time, the miscellaneous function is then simultaneously performed. Multiple codes of the miscellaneous function are specified in a block, its code will be performed in sequence.
- (3) The strobe signal F007#3 is set to 1 when performing TXX.
- (4) The end signal TFIN (G000#5) and FIN (G000#0) are set to 1 by PLC when the operation is completed. If these functions, namely, the M, S and T code miscellaneous functions are performed simultaneously, the end signal FIN(G000#0) can be set to 1 till all of these functions are executed.
- (5) M, S and T codes may be performed simultaneously in a block. The CNC can be performed next block after affirming the end signal FIN is set to 1.

Signal The register signal of M code miscellaneous function

M00~M99 (F026~F033)

The strobe signal of M code miscellaneous function

MFEFD (F007#0)

[Type] Signal output

[Function] These signals are specified the miscellaneous function of the PLC.

[Output condition] Refer to explanation of the “M code miscellaneous function in Section 7.1” for the output condition and execution process.

Note 1: The following miscellaneous function can be treated in the CNC: they can not be outputted even if they are specified in the program:

- * M98, M99
- * The M code for calling subprogram
- * The M code for calling the user macro program

Note 2: The encoding signal also can be outputted other than the code signal and strobe signal in the following miscellaneous function.

M00, M01, M02, M30

Note 3: The M codes from the M00 to M39 can be supplied based upon the binary encoding.

For example: M5 is corresponding to the 00000101

M encoding signal

DM00 (F009#7)

DM01 (F009#6)

DM02 (F009#5)

DM30 (F009#4)

[Type] Signal output

[Function] These signals are shown that the miscellaneous function has been specified actually. The corresponding table between miscellaneous function and output signal in the program code are shown below:

Table 7-3-2

Program code	Signal output
M00	DM00
M01	DM01
M02	DM02
M30	DM30

[Output condition] The M encoding signal is set to 1 when the following conditions are described.

- Specify the corresponding miscellaneous function, and any specified move command and dwell code is completed at the same block. However, when the end signal of the miscellaneous function returns before the move code and dwell code, these signals are then not outputted.

The M encoding signal bit is 0 when the following conditions are performed:

- FIN signal bit is 1.
- When it is reset.

The end signal of M code miscellaneous function

MFIN<G000#1>

Response signal of M code miscellaneous function

MRESP<G063#0>

[Type] Signal input

[Function] It means that the M code miscellaneous function is completed.

[Motion] Refer to the “M code miscellaneous function in Section 7.1” for the treatment and process in the control unit.

The strobe signal of S code miscellaneous function

TF (F007#2)

[Type] Signal output

[Function] These signals are shown that the spindle speed function has been specified

actually.

[Condition output] Refer to the “S code miscellaneous function in Section 7.2” for the output condition and performance process.

The end signal of S code miscellaneous function

SFIN<G000#4>

The response signal of S code miscellaneous function

SRESP<G063#1>

[Type] Signal input

[Function] It means that the S code miscellaneous function is completed.

[Motion] Refer to the “S code miscellaneous function in the Section 7.2” for the treatment and performance process of the control unit.

Tool function strobe signal

BF (F007 #3)

[Type] Signal output

[Function] These signals are shown that the tool function has been specified actually.

[Condition output] Refer to the “T code miscellaneous function in Section 7.3” for the output condition and performance process.

Tool function end signal

TFIN<G000#5>

[Type] Signal input

[Function] It means that T code miscellaneous function is completed.

[Motion] Refer to the “T code miscellaneous function in Section 7.3” for the treatment and performance of the control unit.

Miscellaneous function end signal

FIN (G000 #0)

[Type] Signal input

[Function] This signal shows the end of the M, S and T code miscellaneous functions.

[Motion] When this signal is 1, refer to the explanations in Section 7.1, 7.2 and 7.3 for the operation and treatment of the control unit.

Caution

All of these functions abovementioned are shared with one end signal FIN (G000#0); this signal should be set to 1 after the overall functions are completed.

Signal address

	#7	#6	#5	#4	#3	#2	#1	#0
G000			TFIN	SFIN			MFIN	FIN
G063							SRESP	MRESP

F007					BF	TF		MF
F009	DM00	DM01	DM02	DM30				

7.4 Miscellaneous Function Lock

Brief It is forbidden to perform the specified M, S and T functions. This function is used for detecting the program even if the code signal and strobe signal are not output.

Signal Miscellaneous function lock signal

AFL (G021 # 3)

[Type] Signal input

[Function] This signal selects the miscellaneous function lock. That is, this signal is not permitted to perform the specified S, T and partition M functions.

[Motion] When the signal is set to 1, the functions of the control unit are shown below:

1. As for the Auto, DNC and MDI operations, the control unit does not perform the specified M, S and T functions, namely, the code and strobe signals are not output.
2. This signal is set to 1 after the code signal is output, normally, perform the output operation till it ends. (to the manual FIN signal, and the strobe signal is set to 1.)
3. The miscellaneous functions, for example, M00, M01, M02 and M03 can be performed, even if this signal is set to 1. The overall code, strobe and encoding signals are output based upon the normal method.
4. The miscellaneous functions M98 and M99 can be performed based upon the normal method, even if this signal is set to 1, however, the performance result does not output in the control unit.

Caution: The spindle analog output is still performed even if this signal is set to 1.

The detection signal of miscellaneous function

MAFL (F004 # 4)

[Type] Signal output

[Function] This signal indicates the state of the miscellaneous function lock signal.

[Condition output] The miscellaneous function lock signal AFL is 1 when this signal is set to 1

The miscellaneous function lock signal AFL is 0 when this signal is set to 0.

Signal address

	#7	#6	#5	#4	#3	#2	#1	#0
G021					AFL			
F004				MAFL				

CHAPTER EIGHT SPINDLE VELOCITY FUNCTION

8.1 Spindle Velocity Control Method

Brief GSK218MC divides the spindle into gear spindle and analog spindle based upon the control method.

1. In the gear spindle, the CNC controls the spindle speed by which the S code turns into switch value and then outputs to the spindle.
2. In the analog spindle, the CNC controls the spindle speed by which the S code turns into analog value and then outputs to the spindle.

The I/O point or analog value control can be set by bit 2 of bit parameter No.1.

8.1.1 Gear Spindle

Brief The gear spindle means that the spindle S code is controlled by I/O.

Signal

Spindle speed strobe signal

TF (F007 #2)

Gear spindle address signal

F22#0~F22#7

[Type] Signal output

[Function] These signals have been indicated that the specified spindle speed function has been performed actually.

[Condition output] Refer to the “S code miscellaneous function in Section 7.2 for spindle S code I/O point control” for the output condition and performance process.

Note: S code range: S1~S8, the alarm may occur if it exceeds its range, S1~S8 are separately corresponding with the F address signal F022#0~#7. User can refer to three gears (S1, S2 and S3) of the configured ladder diagram from the system. So, S4~S8 can not be used, the corresponding ladder diagram should be added if the user needs.

8.1.2 Analog Spindle

Brief Analog spindle is that the spindle speed is controlled by the analog voltage value of the CNC. CNC can be controlled the spindle speed of which the S code turns into the analog voltage

value outputting to the machine's spindle..

Actual output analog voltage value = spindle controlled S value x spindle override.

Signal Spindle override code detection signal (G019#0~G019#2)

[Input] Signal input

[Function] It is the spindle override code detection signal

Totally, there are 3 binary system code signals of the spindle override code detection signal which is corresponding to the override:

So, the spindle override can be selected based upon the 10% unit within the 50~120%.

When the spindle speed control is performed instead of using the spindle speed override, the setting override value is 100%.

Notice: The spindle speed override function in the tapping cycle and thread cutting is disabled.

Gear shift treatment

Although the S code is spindle speed, its actual controlled member is spindle motor, and therefore, the CNC should be affirmed the corresponding relations between spindle motor speed and gear. The CNC selects the gear shift based upon the defined speed range of each gear shift in advance, as it is directly selected by S code. The PLC can be selected the corresponding gear shift using its selection signal (GR3, GR2 and GR1). Simultaneously, the CNC outputs the spindle motor speed based upon the selected gear shift. Specify the S0~S99999 and CNC output corresponding codes with the spindle speed in the MDI operation. Two or three speed gear shifts (GR1, GR2 and GR3) can be set by parameter No.246~248, and then the gear shift selection signal can be output at the same time. When the gear shift selection signal changes, the SF signal is simultaneously output.

The meaning of the gear shift signal is shown below:

Table 8-1-2-1

	the 2 nd gear	the 3 rd gear	Remark
GR1	Low	Low	Low: Low speed gear
GR2	High	Middle	Middle: intermediate speed gear
GR3		High	High: high speed gear

- When the code voltage is 10V, spindle speed A at low speed shift (Parameter No246) (min^{-1})
- When the code voltage is 10V, spindle speed B at the high speed shift (Parameter No.247) (min^{-1}) (Medium speed gear at the 3rd gear).
- When the code voltage is 10V, spindle speed C at the high speed shift (Parameter No.248) (min^{-1}) (the 3rd gear).

S code command is performed with the spindle motor speed code voltage (0~10V) and

the gear shift selection signal.

The relationships among the GR1, GR2 and GR3 are shown above:

Signal: Gear shift selection signal

GR1,GR2,GR3

<F034#0~#2>

[Type] Signal input

[Function] These signals are informed the gear shift selected by PLC.

[Condition output] Refer to the gear shift method for the explanation of these signals.

Gear shift selection signal (Input)

GR1,GR2,GR3<G002#0~#2>

[Type] Signal input

[Function] These signals are informed the current selected gear shift of the CNC.

[Condition output] Refer to the gear shift method for the explanation of these signals.

Gear shift in-position signal

GEAR<G002#4>

[Type] Signal input

[Function] These signals that are informed the current selected gear shift of the CNC has been performed its in-position.

[Condition output] Refer to the gear shift method for the explanation of these signals.

Signal address

	# 7	# 6	# 5	# 4	# 3	# 2	# 1	# 0
G002				GEAR		GR3	GR2	GR1
G022			SPOV	OVC	SMOV			
F007						TF		
F034						GR3	GR2	GR1

8.2 Rigid Tapping

Brief The rigid tapping is synchronized the tapping axis and spindle axis in the common tapping canned cycle.

The CNC needs to detect the rotation direction signal of the spindle ensuring the direction and processing of the cutting feed during the rigid tapping (during performing G74 and G84).

Performance processing:

Spindle rotates → Z axis feed tapping → sending the M05 stop code to spindle → after the

spindle is absolutely stopped → sending a reverse code → Z axis retracts to the start → spindle stops

The corresponding ladder diagram should be compiled for carrying out the rigid tapping; inform the rotation direction of the CNC external spindle.

Signal: Rigid tapping signal

RG TAP (G003#1)

[Type] Signal output

[Function] That this signal informs PLC has been in the mode of the rigid tapping.

[Condition output] RG TAP 1: It is rigid tapping mode at present.

0: It does not tapping mode at present.

Signal address

	#7	#6	#5	#4	#3	#2	#1	#0
G003							RG TAP	

CHAPTER NINE PROGRAMMING CODE

9.1 User Macro Program

Brief It is very essential to perform the same operation repeatedly for the subprogram, but the variable, arithmetic, calculation, logic operation and condition branch can be used for the user macro program function, which is very easy to develop the current program. The machining program can be called the user macro program by a simple code, as the calling of the subprogram.

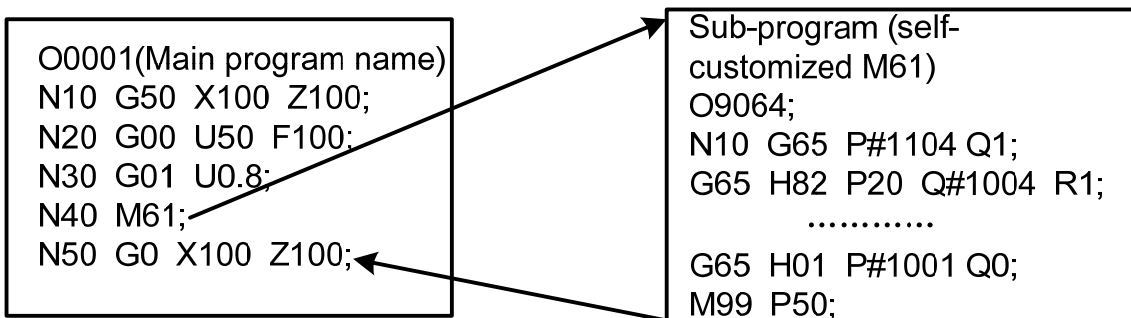

Fig. 9-1-1

It means that one function is programmed by the user macro, which becomes the general function. Namely, the data variable (changeable and undefined data) can be compiled the program. For example, the user macro program can be used for the composed technology.

Signal User macro program input signal

UI000~UI015 (G054, G055)

[Type] Signal input

[Function] Do not offer any function to the controllable unit. These signals are regarded as one of the system variable, which is read by the macro program, and it is used for the interface signal between macro program and PLC.

The corresponding system variables of these signals are shown below:

Table 9-1-1

Signal	Address	Variable
UI000	G54#0	#1000
UI001	G54#1	#1001
UI002	G54#2	#1002
UI003	G54#3	#1003
UI004	G54#4	#1004
UI005	G54#5	#1005
UI006	G54#6	#1006

UI007	G54#7	#1007
UI008	G55#0	#1008
UI009	G55#1	#1009
UI010	G55#2	#1010
UI011	G55#3	#1011
UI012	G55#4	#1012
UI013	G55#5	#1013
UI014	G55#6	#1014
UI015	G55#7	#1015
UI000~UI015	G54, G55	#1032

Note: # 1032 is the 16-bit variable, which is composed as follows:

Signal address

	# 7	# 6	# 5	# 4	# 3	# 2	# 1	# 0
# 1032	UI007	UI006	UI005	UI004	UI003	UI002	UI001	UI000
# 1032	UI015	UI014	UI013	UI012	UI011	UI010	UI009	UI008

User macro program output signal

UO000~UO015

(F054~F055)

[Type] Signal output

[Function] Do not offer any function to the controllable unit. These signals are regarded as a kind of variable which is read or written by the user macro program, and it is used for the interface signal between macro program and PLC.

The corresponding system variables of these signals are shown below:

Table 9-1-2

Signal	Address	Variable
UO000	F54#0	#1100
UO001	F54#1	#1101
UO002	F54#2	#1102
UO003	F54#3	#1103
UO004	F54#4	#1104
UO005	F54#5	#1105
UO006	F54#6	#1106
UO007	F54#7	#1107
UO008	F55#0	#1108
UO009	F55#1	#1109
UO010	F55#2	#1110
UO011	F55#3	#1111
UO012	F55#4	#1112

UO013	F55#5	#1113
UO014	F55#6	#1114
UO015	F55#7	#1115
UO000~UO015	F54,F55	#1132

Note: # 1132 is the 16-bit variable.

It composes of as follows:

	# 7	# 6	# 5	# 4	# 3	# 2	# 1	# 0
# 1132	UO007	UO006	UO005	UO004	UO003	UO002	UO001	UO000
# 1132	UO015	UO014	UO013	UO012	UO011	UO010	UO009	UO008

9.2 Canned Cycle

Brief Canned cycles can be simplified the program. With a canned cycle, a frequently-used machining operation can be specified in a single block with a G function; without canned cycles, normally more than one block is required. In addition, the use of canned cycles can shorten the program to save memory.

Explanations: A canned cycle consists of a sequence of 6 operations:

- Operation 1 Positioning a hole position
- Operation 2 Rapid traverse up to Point R level
- Operation 3 Hole machining
- Operation 4 Operation at the bottom of a hole
- Operation 5 Retraction to point R level
- Operation 6 Rapid traverse up to the initial point

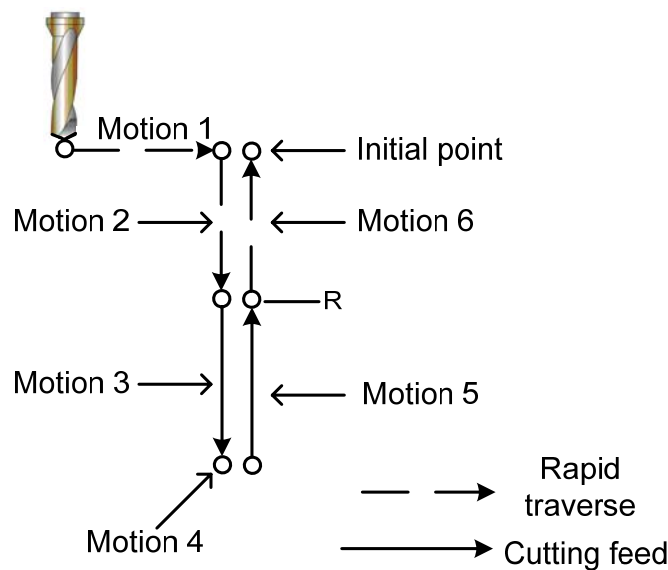

Fig. 9-2-1 Canned cycle operation sequence

Spindle control: Output the spindle code of the reverse rotation in some canned cycle.

The following canned cycles are required the spindle control:

Reverse tapping cycle G74 Fine boring cycle G76

Tapping cycle G84 Boring cycle G86

Counter boring cycle G87 Boring cycle G88

Using the frequently-used miscellaneous functions for the spindle control:

Refer to the miscellaneous function explanations.

M03: Spindle positive

M04: Spindle negative

M05: Spindle stop

M19: Spindle orientation

Tapping signal: Output the tapping signal during the tapping cycle. The tapping signal also can be output when tapping cycle G code is enabled.

Override: The cutting feed override is always set to 100% during tapping.

Feed dwell: The move may not stop immediately during tapping when pressing the feed dwell key. The move stops when the tool returns to the R panel.

Dry run: Whether the dry run is enabled during the TDR (bit 5 of parameter No.12) defines tapping.

Signal: Tapping signal

TAP<F001#5>

[Type] Signal output

[Function] It informs that the system is in the tapping mode.

[Condition output] This signal is 1:

- When the system is in the tapping cycle mode G74 and G84
- When the system is in the tapping mode G63.

This signal is 0:

- When the system is neither in the tapping cycle mode nor in the tapping mode
- When the reset or ESP signal is input

Signal address

	#7	#6	#5	#4	#3	#2	#1	#0
F001			TAP					

CHAPTER TEN DISPLAY/SETTING

10.1 Clock Function

Brief The Year, Month and Day are displayed on the setting screen.

(Note: the clock is only set on the screen.)

10.2 Operation Record Display

Brief This function can be displayed the history operation record by the operating the MDI key and signal when the error occurs or CNC alarm issues.

10.3 Help Function

Brief The CNC alarm and the details of the CNC operation can be displayed on the screen using the help function.

Detailed information of alarm: The help screen displays the generated alarm and that how to release the alarm information. However, the information from the P/S alarm is displayed, which is easy to be distorted or misunderstood.

CHAPTER ELEVEN MEASURING

11.1 Skip Function

Brief Linear interpolation can be commanded by specifying axial move following the G31, like G01. If an external signal is input during the execution of this command, execution of the command is interrupted and the next block is executed.

The skip function is used when the end of measuring is not programmed but specified with a signal from the machine, for example, in grinding. It is used also for measuring the dimensions of a workpiece.

The coordinate values when the skip signal is turned on can be used in a custom macro because they are stored in the custom macro system variable #5016~#5019, as follows:

- #5016** X axis position of EOB
- #5017** Y axis position of EOB
- #5018** Z axis position of EOB
- #5019** 4th axis position of EOB

Signal Special signal

SKIPP <G001#1>

[Type] Signal input

[Function] This signal completes the skip cutting. Namely, the position of skip signal turns into "1" in the block including the G31, which is stored in the user macro variable, simultaneously, the move code of the block is ended.

[Operation] The controllable equipments are shown in the following when the skip signal turns into "1":

- When the block consists of the skip machining code G31, the current position of the code axis when the control equipment is read and stored the signal that it is set to 1. The control equipment stops the move of the axis, and then, clear the remaindering move distance of this block code axis.
- The state of the skip signal is monitored instead of its rising edge. In this case, if the skip signal is still "1", it is regarded as the skip condition is met immediately when next skip cutting is commanded.

Note: The requirement of the skip signal width is at least 10ms.

Signal address

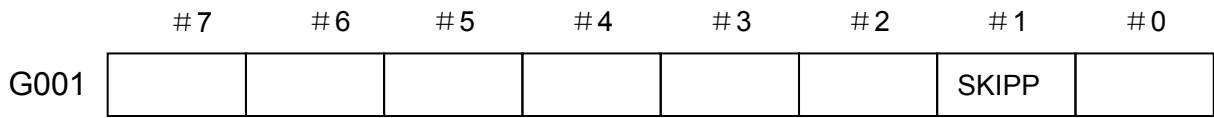

CHAPTER TWELVE PANEL LOCK SETTING

Signal Program edit locking signal

LEDT (G016#6)

[Type] Signal input

[Function] This signal locks the edit function of the program.

[Motion] The program edit function is enabled when signal is set to 1.

The program edit function is disabled (The program can not be compiled) when the signal is set to 0.

LSYS (G016#7)

[Type] Signal input

[Function] This signal locks the button on machine's operation panel.

[Motion] The overall button on the machine's operation panel is locked and disabled when the signal is set to 1.

The machine operation button is enabled when the signal is set to 0.

Signal address

	# 7	# 6	# 5	# 4	# 3	# 2	# 1	# 0
G016	LSYS	LEDT						

Appendix one Address Between PLC and CNC

1: CNC → PLC addresses: F000 ----- F064

Appendix table -1

Signal	Symbol	Address
Feed hold indicator signal	SPL	F000#4
Cycle start indicator signal	STL	F000#5
Servo ready signal	SA	F000#6
Automatic operation signal	OP	F000#7
Alarm signal	AL	F001#0
Resetting signal	RST	F001#1
Spindle velocity arrival signal	SAR	F001#3
Spindle enabling signal	ENB	F001#4
Tapping signal	TAP	F001#5
Rigid tapping execution	DTAP	F001#6
G63 tapping method signal	MTAP	F001#7
Screw cutting signal	THRD	F002#3
Program start signal	SRNMV	F002#4
Cutting feed signal	CUT	F002#6

Signal	Symbol	Address
Dry run inspection signal	MDRN	F002#7
Incremental feed selection inspection signal	MINC	F003#0
MPG feed selection inspection signal	MH	F003#1
JOG feed inspection signal	MJ	F003#2
Manual data input inspection signal	MMDI	F003#3
DNC operation selection confirmation signal	MRMT	F003#4
Auto operation selection inspection signal	MMEM	F003#5
Memory editing selection inspection signal	MEDT	F003#6
Mechanical zero-return selection inspection signal	MZRO	F003#7
Skip optional block inspection signal	MBDT	F004#0
The overall axes machine locking inspection signal	MMLK	F004#1
Single block inspection signal	MSBK	F004#3
Miscellaneous function locking signal	MAFL	F004#4
Manual reference point inspection return	MREF	F004#5
Feed override cancellation inspection signal	CFORD	F005#0
Spindle override cancellation inspection signal	CSORD	F005#1
M code miscellaneous function strobe signal	MF	F007#0
S code miscellaneous function strobe signal	SF	F007#2
T code miscellaneous function strobe signal	TF	F007#3
External operation panel locking	LOPT	F008#0
Regardless of the hard limit	LALM	F008#1
Regardless of the ESP signal	EALM	F008#2
Tool-change in executing	RCT	F009#0
M30 decoding signal	DM30	F009#4
M30 decoding signal	DM02	F009#5
M30 decoding signal	DM01	F009#6
M30 decoding signal	DM00	F009#7
System type selection signal (0:218MC-H/-V, 1:218MC)	CNCS	F010#0
Syntax inspection operation signal	SCHK	F010#1
The system type selects the 218MC-U1 when the F010#0 and F010#2 are simultaneously set as 1.		F010#2
Electric MPG drive state signal	RHPG	F010#7
Spindle velocity arrival signal	SAR	F011#0
Spindle zero-velocity inspection signal	ZSP	F011#1
Spindle orientation completion signal	COIN	F011#2
Velocity/position shifting completion signal	VPO	F011#3
Axis zero return end-signal	ZP1 --- ZP5	F016#0 --- #4
Axis movement signal	MV1 --- MV5	F017#0 --- #4
System controllable axis number 1	AXIS1	F018#0
System controllable axis number 2	AXIS2	F018#1

Signal	Symbol	Address
System controllable axis number 4	AXIS4	F018#2
System controllable axis number 8	AXIS8	F018#3
Axis movement direction signal	MVD1 --- MVD5	F019#0 --- #4
The 4 th index worktable releasing signal	BUCLP	F020#0
The 4 th index worktable clamping signal	BCLP	F020#1
+ limit overtravel alarm along with the 1 st axis	AL+1	F021#0
+ limit overtravel alarm along with the 2 nd axis	AL+2	F021#1
+ limit overtravel alarm along with the 3 rd axis	AL+3	F021#2
+ limit overtravel alarm along with the 4 th axis	AL+4	F021#3
+ limit overtravel alarm along with the 5 th axis	AL+5	F021#4
Spindle I/O point	SCODE1-- -SCODE8	F022#0---#7
- limit overtravel alarm along with the 1 st axis	AL-1	F023#0
- limit overtravel alarm along with the 2 nd axis	AL-2	F023#1
- limit overtravel alarm along with the 3 rd axis	AL-3	F023#2
- limit overtravel alarm along with the 4 th axis	AL-4	F023#3
- limit overtravel alarm along with the 5 th axis	AL-5	F023#4
M code miscellaneous function register signal	M**	F026 --- F033 (it can be registered the address in the register table, refer to the Section 3.5 in <i>CHAPTER THREE OPERATION</i> for details.
Spindle analog amount control gear selection signal	GR1, GR2, GR3	F034#0 --- #2
Axis returns to the 1 st reference position end signal	ZP11—ZP 14	F041#0 --- #3
Axis returns to the 2 nd reference position end signal	ZP21---ZP 24	F042#0 --- #3
Axis returns to the 3 rd reference position end signal	ZP31---ZP 34	F043#0 --- #3
Axis returns to the 4 th reference position end signal	ZP41---ZP 44	F044#0 --- #3
The area detection signal of the 2 nd reference position along with the 3 rd axis	AQ1	F045#0
The area detection signal of the 3 rd reference position along with the 3 rd axis	AQ2	F045#1
The area detection signal of the 4 th reference position along with the 3 rd axis	AQ3	F045#2
User macro program output signal	UO000 --- UO015	F054,F055 F056 --- F059

Signal	Symbol	Address
	U100 --- U131	
The established signal of the reference position	ZRF1 ---- ZRF5	F060#0 --- #4
The arrival signal of the required components	ESEND	F061#1
The operation signal of reference position return along with axis	ZRFJ1 ---- ZRFJ5	F061#2 --- #6

Appendix two the addresses of PLC → CNC: G000 ----- G064

Appendix table-2

Signal	Symbol	Address
Miscellaneous function end signal	FIN	G000#0
M code miscellaneous function end signal	MFIN	G000#1
S code miscellaneous function end signal	SFIN	G000#4
T code miscellaneous function end signal	TFIN	G000#5
ESP signal	ESP	G001#0
Skip signal	SKIPP	G001#1
Gear selection signal (input)	GR1,GR2, GR3	G002#0 --- #2
Spindle analog amount control gear in-position signal	GEAR	G002#4
Rigid tapping signal	RGTAP	G003#1
User macro interruption signal	UINT	G009#1
Axis image signal	MT1---MT5	G010#0---#4
Rapid override encode signal	RV0 --- RV1	G011#0 --- #1
Rapid override encode signals 1, 2, 4, 8 and 16	FV1, FV2, FV4, FV8, FV16	G011#3 --- #7
Overtravel signal	*+L1 --- *+L5 *-L1 ---- *-L5	G012#0 ---- #4 G013#0 ---- #4
Editing locking signal	LEDT	G016#6
Operation panel locking signal	LSYS	G016#7
Zero-return deceleration signal detection		G017#0 ---- #4
Additional axis selection	AXIS1, AXIS2, AXIS4, AXIS8	G018#0 ---- #4
Spindle override encode detection signal	SV1, SV2, SV4, SV8	G019#0 ---- #3
Editing mode		G020#0
Auto mode		G020#1
MDI mode		G020#2
Zero-return mode		G020#3
Single-step mode		G020#4
Manual mode		G020#5
MPG mode		G020#6
DNC mode		G020#7

Signal	Symbol	Address
Skip		G021#0
Single block		G021#1
Dry run		G021#2
M.S.T lock		G021#3
Machine lock		G021#4
Selection stop		G021#5
Program restart		G021#6
Spindle positive		G022#0
Spindle stop		G022#1
Spindle negative		G022#2
Spindle override cancel		G022#4
Spindle JOG		G022#6
Channel selection signal		G022#7
Lubrication		G023#0
Cooling		G023#1
Chip-removal		G023#2
Cycle start		G023#6
Feed hold		G023#7
Feed override cancel		G024#1
Rapid switch		G024#7
MPG/incremental feed movement amount selection signal	MP1, MP2	G026#4 ---- #5
Manual feed axis +1 st		G027#0
Manual feed axis + 2 nd		G027#1
Manual feed axis + 3 rd		G027#2
Manual feed axis + N th		G027#3
Manual feed axis -1 st		G028#0
Manual feed axis -2 nd		G028#1
Manual feed axis -3 rd		G028#2
Manual feed axis - N th		G028#3
Spindle orientation		G029#0
Tool-magazine zero-return		G029#1
Clamping/releasing tool		G029#2
Tool-magazine positive		G029#3
Tool-magazine negative		G029#4
Tool-magazine tool-pivoting		G029#5
Tool-magazine tool-return		G029#6
Tool-changer		G029#7
Overtravel releasing		G030#0
Spindle stop signal	*SSTP	G032#7
Spindle velocity command output polarity selection signal	SGN	G033#5
Spindle velocity command polarity selection signal	SSIN	G033#6

Signal	Symbol	Address
Index worktable releasing completion signal	BEUCL	G038#6
Index worktable clamping completion signal	BECLP	G038#7
Teaching function start signal	TEACH	G042#0
The 1 st reference position detection permission signal		G056#0 ----- #4
The 2 nd reference position detection permission signal	PREF20----PREF23	G057#0 ----- #4
The 3 rd reference position detection permission signal	PREF30----PREF33	G058#0 ----- #4
The 4 th reference position detection permission signal	PREF40----PREF43	G059#0 ----- #4

Appendix three system operation state addresses

Series No.	Signal	Symbol	Address
000--004	The pulse No. after the axis outputs to the driver by the electric gear ratio.		0000I--0004I
005	The pulse No. after the tapping axis outputs to the driver by electric gear ratio.		0005I
006~010	The pulse No. from the driver feedback by electric gear ratio		0006I~0010I
011--015	Axis pulse/accumulation pulse error		0011I~0015I
016	The M code is being executed.		0016I
017	The S code is being executed.		0017I
018	Series port 0 in communication		0018I
019	Series port 1 in communication		0019I
020	System memory remainder (K)		0020I
021	Current acceleration velocity		0021F
022	Increase the current acceleration velocity		0022I
023	Current spindle override		0023F
024	Current feed override		0024F
025	Current rapid override		0025F
026	Current single-step length		0026F
027	Post-acceleration lag shifting		0027F
028	EOB velocity		0028F
029	Current JOG selection feed axis		0029I
030	16-bit macro variable input		0030I
031	16-bit macro variable output		0031I
032	Execute the G04 remainder dwell time		0032I
033	The overall cutting time of the system		0033I
034	The overall starting-up time of the system		0034I
035~037	Power-supply voltage	1, 2, 3	0035F~0037F

Series No.	Signal	Symbol	Address
038	PLC interruption		0038I
039	The in-position detection is being performed		0039I
040	Waiting for the spindle arrival signal		0040I
041	The remaining interval compensation value of the 1 st axis		0041F
042	The remaining interval compensation value of the 2 nd axis		0042F
043	The remaining interval compensation value of the 3 rd axis		0043F
044	The remaining interval compensation value of the 4 th axis		0044F
045	The remaining interval compensation value of the 5 th axis		0045F
046~050	Current block start	X, Y, Z, A, B	0046F~0050F
051~055	Current block end	X, Y, Z, A, B	0051F~0055F
056	Current/sub-block corner angle		0056F
057	Interruption response time		0057F
058	Current MPG increment		0058F
059	One operation pulse lag numbers		0059I
060	Velocity prospective sections		0060I
061	Preprocess sections		0061I
062	Encoding buffering area sections		0062I
063	System's operation mode		0063I
064	The operation mode will be shifted by system		0064I
065	The displayed operation mode by system		0065I
066~069	Spindle velocity analog voltage output value	1, 2, 3, 4	0066F~0069F
072~076	Multi-circle absolute machine zero position along with axis	1, 2, 3, 4, 5	0072F~0076F
077~081	Multi-circle absolute machine current position along with axis	1, 2, 3, 4, 5	0077F~0081F
082~086	Multi-circle absolute motor current position along with axis	1, 2, 3, 4, 5	0082I~0086I
087~091	Machine current position along with axis	1, 2, 3, 4, 5	0087I~0091I
092~096	Axis 4096 circles frequency	1, 2, 3, 4, 5	0092I~0096I
097~101	ABS motor multi-circle numbers along with axis	1, 2, 3, 4, 5	0097I~0101I

Appendix four bus operation state addresses: 0000----- 0042

Series No.	Signal	Symbol	Add.
000	The slave station number of bus connection		0000
001	The slave station number of bus servo		0001

Series No.	Signal	Symbol	Add.
002	The salve station number of bus servo block		0002
003	The slave station number of bus 10-block		0003
004	The slave station number of bus data collection block		0004
005	The slave station number of bus spindle block		0005
006	The slave station number of bus spindle block		0006
007	FPGALINK real-time state word		0007
008	Bus real-time connection state 1: Normal 0: Abnormal		0008
009	Times for FPGALINK repeated transmission once		0009
010	Times for FPGALINK repeated transmission twice		0010
011	FPGALINK disabled, MDT data pack counter		0011
012	MDT data pack counter without FPGALINK		0012
013	MDT data pack connection state without FPGALINK		0013
014	DSP sets the (FPGA)LINK-MDT slave station length		0014
015	LINK state with DSP initialization		0015
017	FPGALINK bus physics connection is ready or not		0017
018	FPGALINK execution time		0018
019	FPGALINK communication cycle		0019
020	Overtime times of FPGALINK receiving MDT		0020
021	Data CRC verification error once times of FPGALINK receiving MDT		0021
022	Data CRC verification error twice times of FPGALINK receiving MDT		0022
023	Read the state word times (within one cycle) in FPGALINKCP6 stage		0023
024	Software response overtime counting in FPGALINKCP6 stage		0024
025	The physical connection OFF times Statistic (reticle or network OFF from other hardwares) of FPGALINK		0025
026	FPGALINK master state PFGA reception/delivery MDT state machine error mark		0026
027	The times of FPGALINKMDT delivery state machine error		0027
028	The times of FPGALINKMDT reception state machine error		0028
029	The top repeatable delivery times of FPGALINK		0029
030	Current stage section numbers of FPGALINK		0030
031	The MDT length of FPGALINK servo station		0031
036	Times for FPGALINK repeated transmission once (Backup)		0036
037	Times for FPGALINK repeated transmission twice (Backup)		0037
038	FPGALINK disabled, MDT data pack counter (Backup)		0038
039	MDT data pack counter without FPGALINK (Backup)		0039
040	MDT data pack connection state without FPGALINK (Backup)		0040

Series No.	Signal	Symbol	Add.
041	DSP sets the (FPGA)LINK-MDT slave station length (Backup)		0041
043	FPGALINK bus physics connection is ready or not (Backup)		0043
044	FPGALINK execution time (Backup)		0044
045	FPGALINK communication cycle (Backup)		0045
046	Overtime times of FPGALINK receiving MDT (Backup)		0046
047	Data CRC verification error once times of FPGALINK receiving MDT (Backup)		0047
048	Data CRC verification error twice times of FPGALINK receiving MDT (Backup)		0048
049	Read the state word times (within one cycle) in FPGALINKCP6 stage (Backup)		0049
050	Software response overtime counting in FPGALINKCP6 stage (Backup)		0050
051	The physical connection OFF times Statistic (reticle or network OFF from other hardwares) of FPGALINK (Backup)		0051
052	FPGALINK master state PFGA reception/delivery MDT state machine error mark (Backup)		0052
053	The times of FPGALINKMDT delivery state machine error (Backup)		0053
054	The times of FPGALINKMDT reception state machine error (Backup)		0054
055	The top repeatable delivery times of FPGALINK (Backup)		0055
056	Current stage section numbers of FPGALINK (Backup)		0056
057	The MDT length of FPGALINK servo station (Backup)		0057

Appendix five DSP operation state addresses: 0000----- 0070

Series No.	Signal	Symbol	Add.
000	DSP scan counter		0000
001	DSP interpolation control point number		0001
002	DSP interpolation completion task times		0002
003	DSP0x1940 error alarm		0003
004	DSP0x1944 error alarm		0004
005	DSPARM control buffering area dimension		0005
006	DSP task completion mark		0006
007	DSP interpolation point buffering area dimension		0007
008	DSP interpolation fitting point number		0008
009	DSP0x19e0 signal capture		0009

Series No.	Signal	Symbol	Add.
010	DSP signal capture 1		0010
011	DSP signal capture 2		0011
012--023	DSP pulse accumulation axis	01, 02, 03, 04, 05, 06, 07, 08, 09, 10, 11, 12	0012—0023
024	DSP spindle 1 pulse accumulation number		0024
025	DSP spindle 2 pulse accumulation number		0025
026	DSP pulse port spindle pulse accumulation number		0026
027	DSP spindle cycle pulse number		0027
028--039	Axis zero-return pulse Z signal position	01, 02, 03, 04, 05, 06, 07, 08, 09, 10, 11, 12	0028—0039
040--051	Axis zero-return pulse Z stop position	01, 02, 03, 04, 05, 06, 07, 08, 09, 10, 11, 12	0040--0051

VOLUME IV
INSTALLATION & CONNECTION

CHAPTER ONE SYSTEM CONFIGURATION & INSTALLATION

1.1 System Composition

GSK218MC CNC system is mainly composed of the following units; refer to the Fig. 1-1.

- (1) GSK218MC CNC system
- (2) Additional operation panel (optional parts)
- (3) Digital AC servo drive unit (step drive unit)
- (4) Servo motor (step motor)
- (5) AC transformer

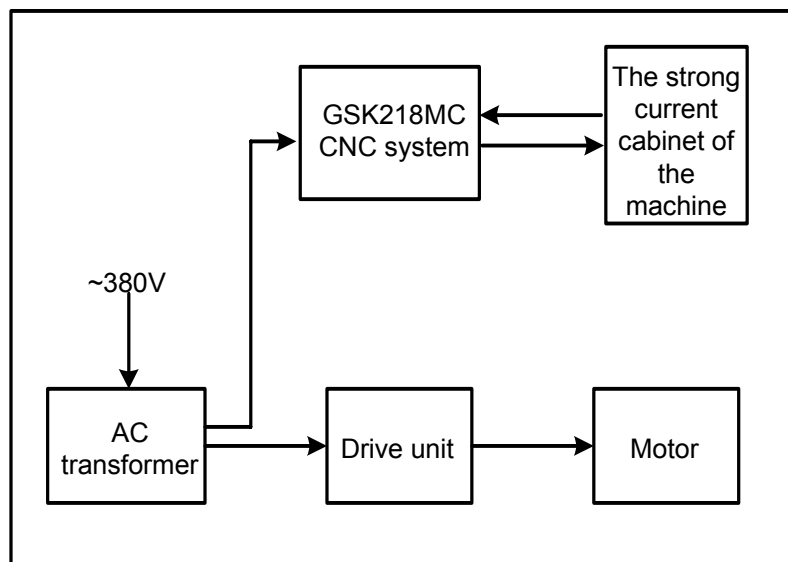

Fig. 1-1

1.2 System Installation and Connection

Firstly, check whether the parts, such as CNC system, the drive unit, the motor and the photoelectric encoder, etc, to be installed are all prepared, in good condition and matched with each other.

The installation of CNC system must be fixed, and some space should be reserved around CNC system, so that the heat of the system can be sent out. The CNC system should be installed not only on the convenient for operating, but also on the place where depart from the machining iron chips and coolant.

The strong and weak currents should be separated, and the power supply of CNC system and the drive unit should be provided by the isolation transformer, and the power supply should be parted with the strong current of the machine. The various cables should keep far away from AC contractor to reduce the interference. It would be best that the photoelectric encoder, the limit signal

and the ESP signal should be connected with CNC system directly rather than come through the strong current cabinet. The power supply must be connected with the earth properly.

Various sockets should be connected and the screw should be fixed tightly, and the joints of cables are not allowed to plug and pull after power on.

Do not scratch the system control panel by the hard or sharp material when installing the CNC control; take down the CNC system if painted to avoid dirtying the system panel.

Do not put the strong electricity or strong magnetism interference source around CNC system; far away from the inflammable, the explosives and various hazard objects.

1.3 CNC System Appearance Installation Dimension Figure

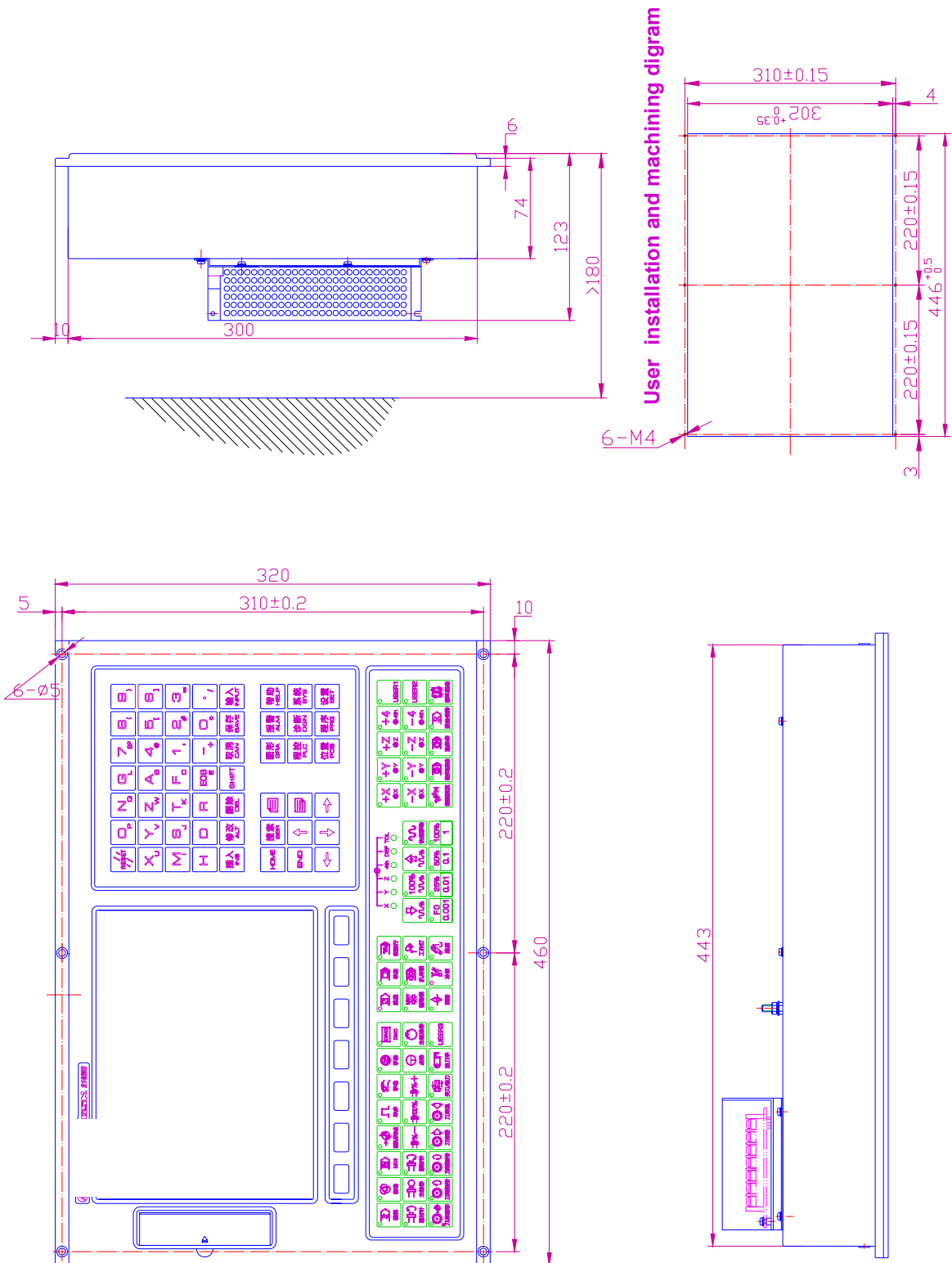

Fig. 1-3-1 Installation dimension figure of GSK218MC integration panel

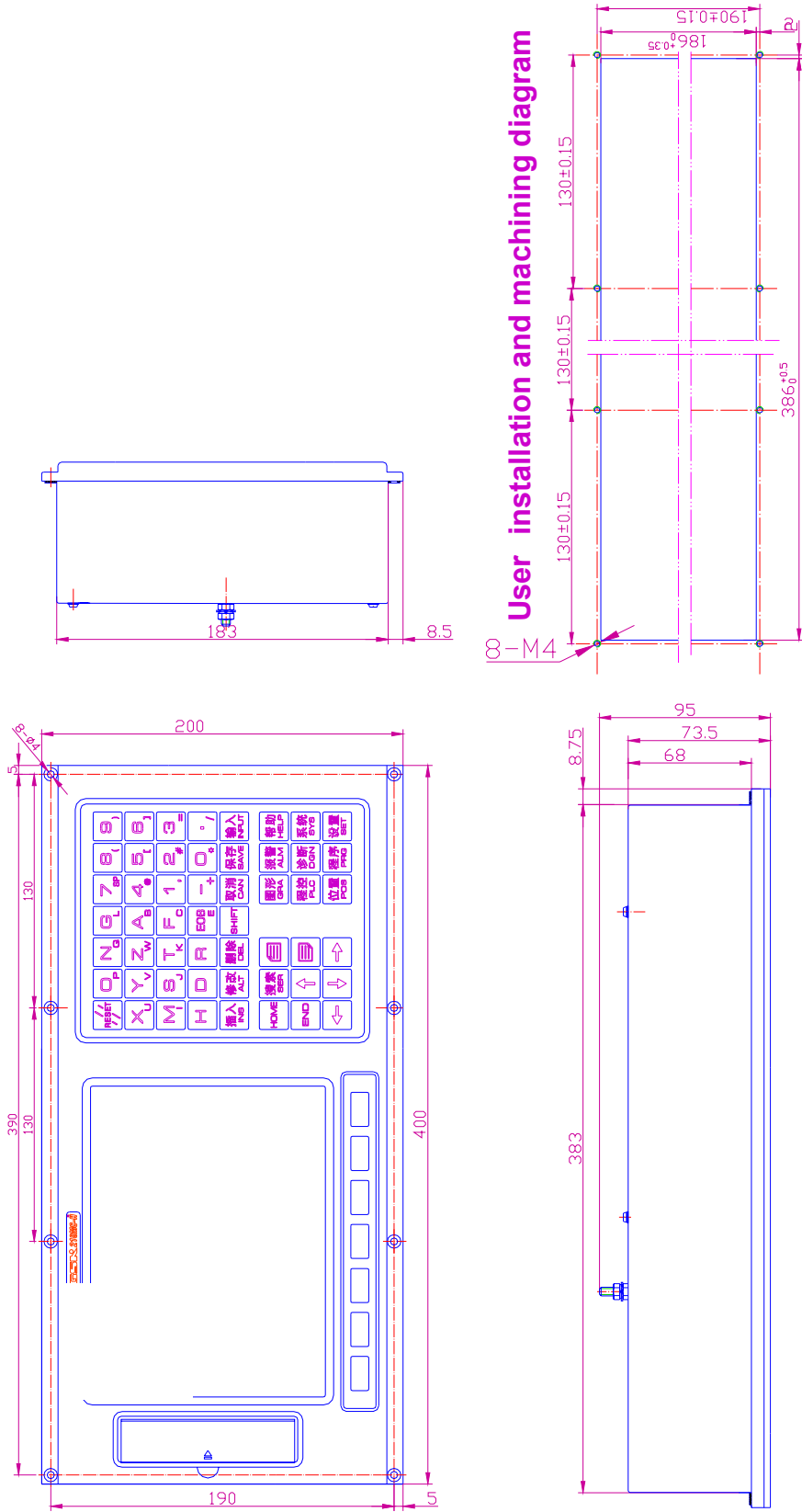

Fig.1-3-2 Installation dimension figure of GSK2-8MC-H editing panel

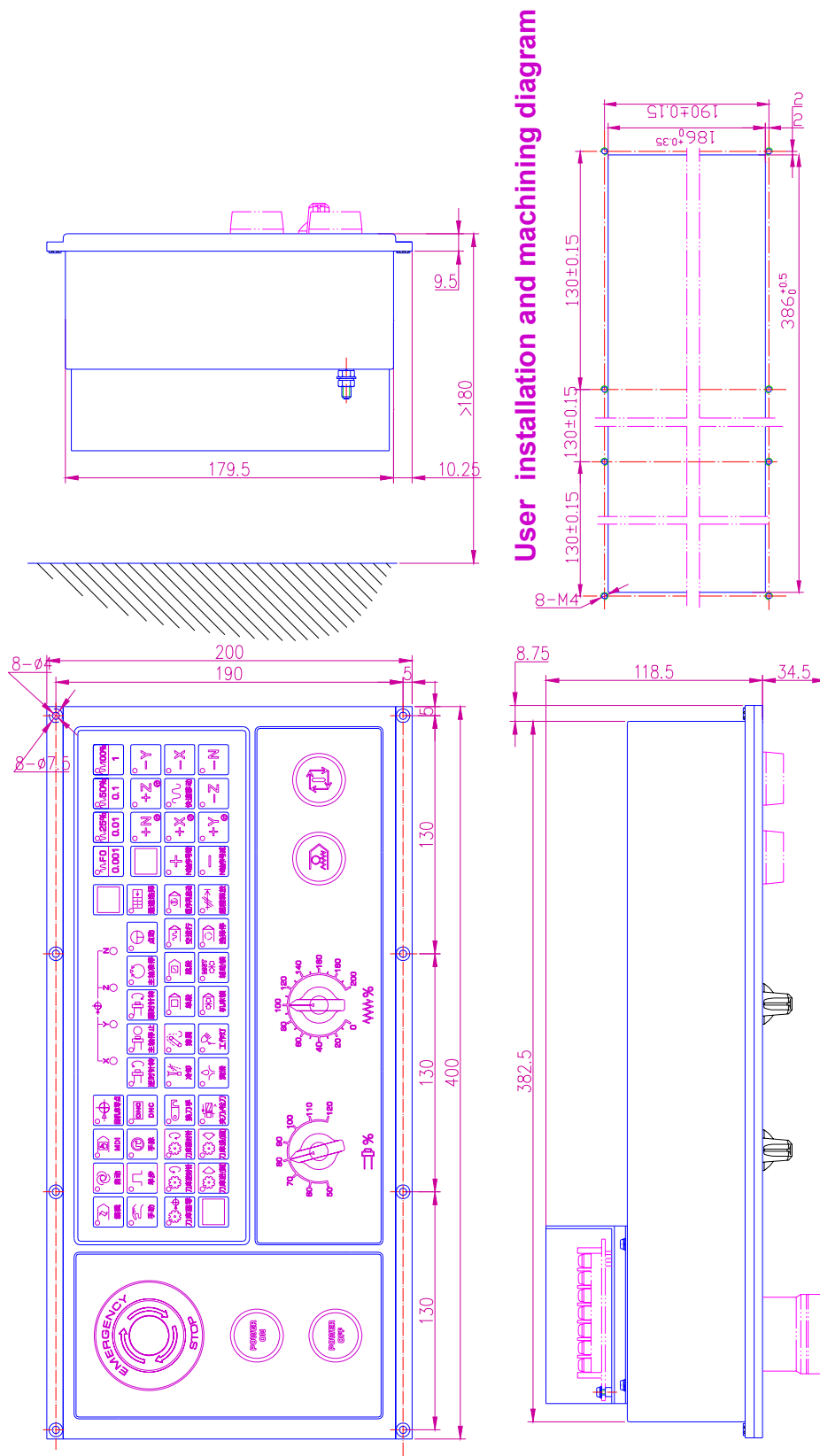

Fig.1-3-3 Installation dimension figure of GSK218MC-H operation panel

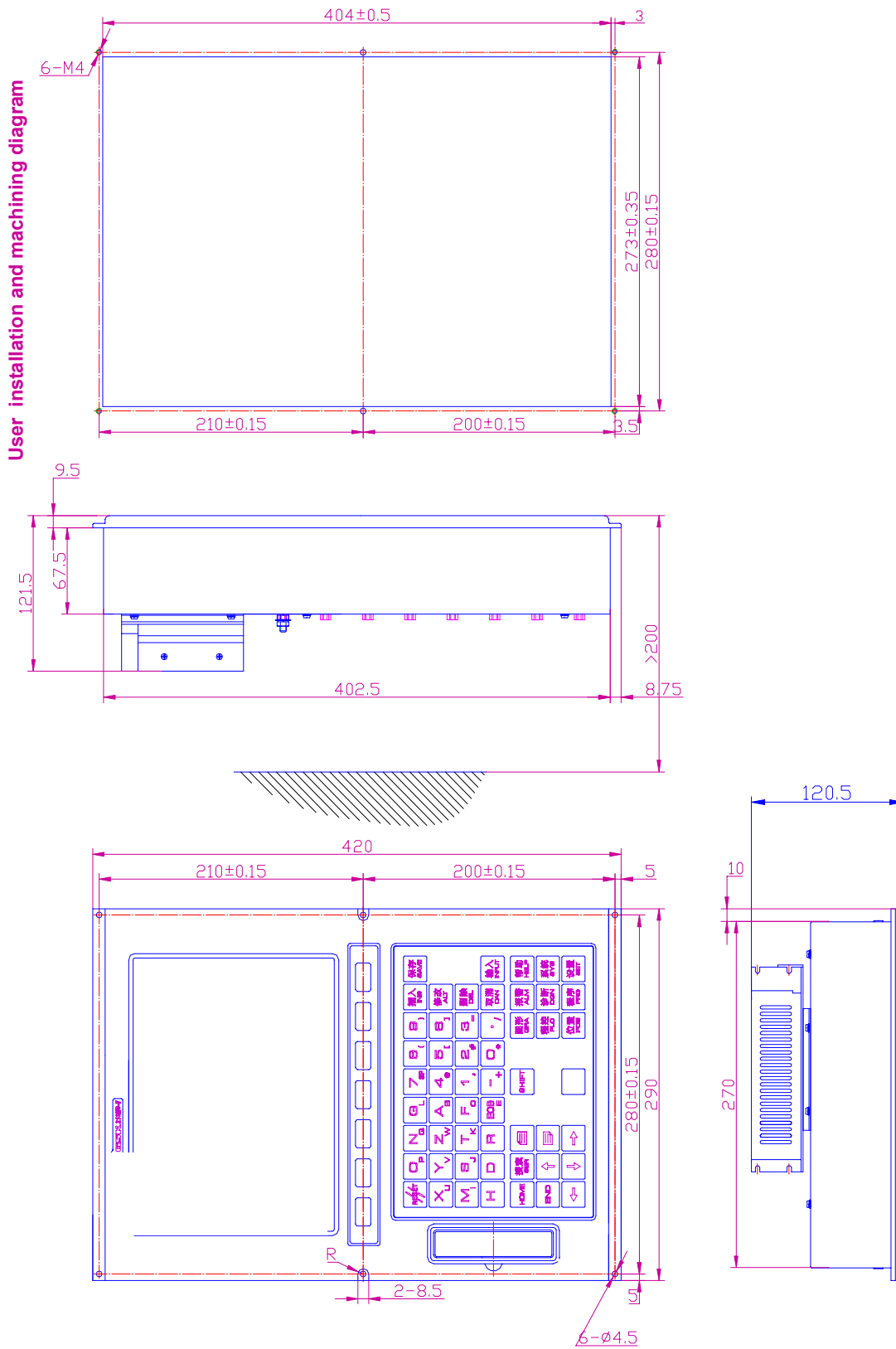

Fig. 1-3-4 Installation dimension figure of GSK218MC-V editing panel

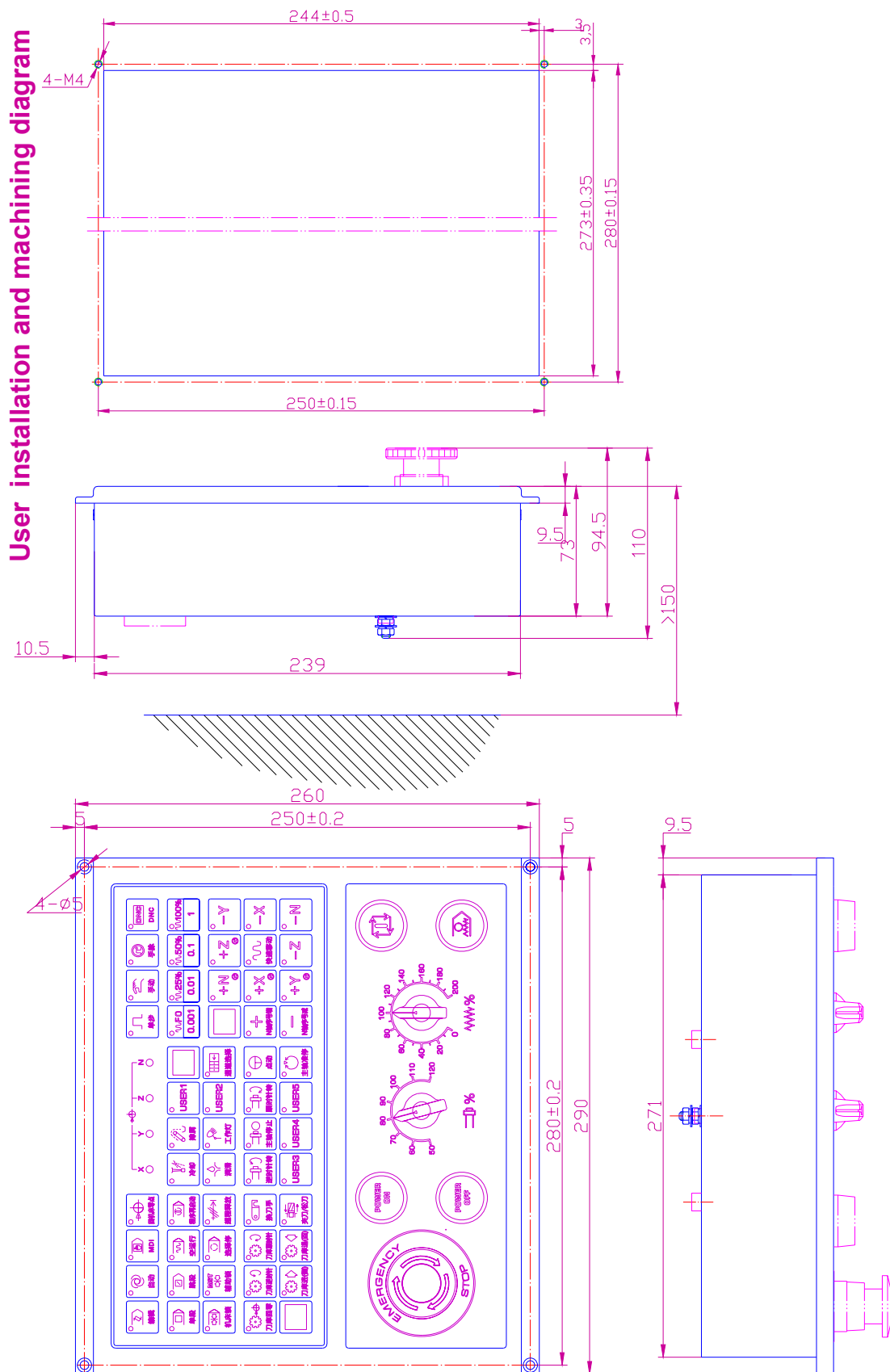

Fig. 1-3-5 Installation dimension figure of GSK218MC-V operation panel

1.4 Additional Panel Figure

GSK218MC and GSK218MC-U1 can be configured the additional panel by user. The extension holes on the panel can be customized its function by user, such as the ESP, Program lock, System ON/OFF, feed hold, Cycle start and MPG etc. Refer to the following accessories:

Electric MPG: Changchun LGF-001-100;

Additional panel:

218MC additional panel: aluminum 460mm×130mm, which can be assembled under the panel;

218MC-U1 additional panel: aluminum 420mm×71mm, which can be assembled under the panel;

ESP button: LAY3-02ZS/1

Non self-locking button: KH-516-B11 (Green or red);

Self-locking button: KH-516-B21 (Green or red);

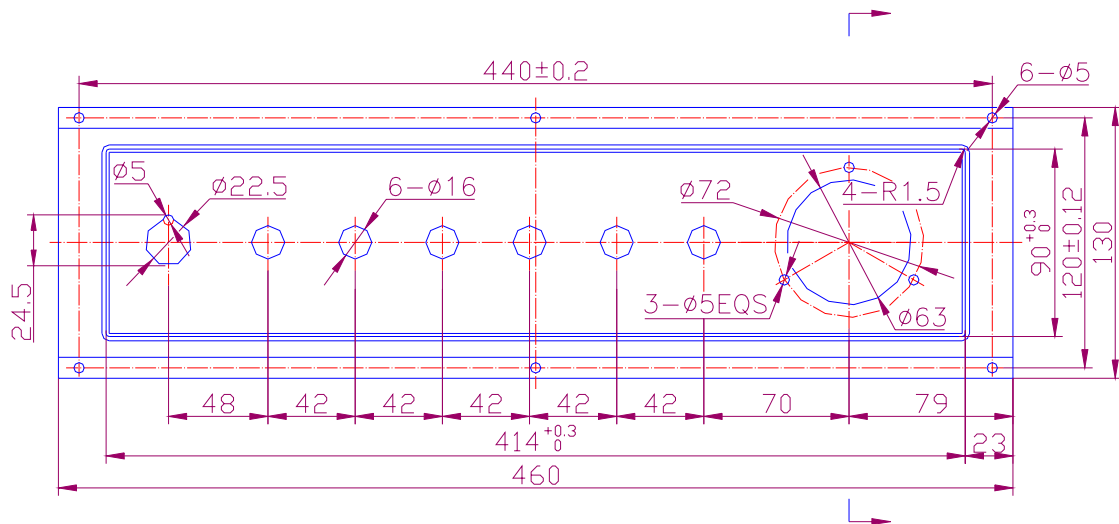

Fig. 1-4-1 GSK218MC additional panel

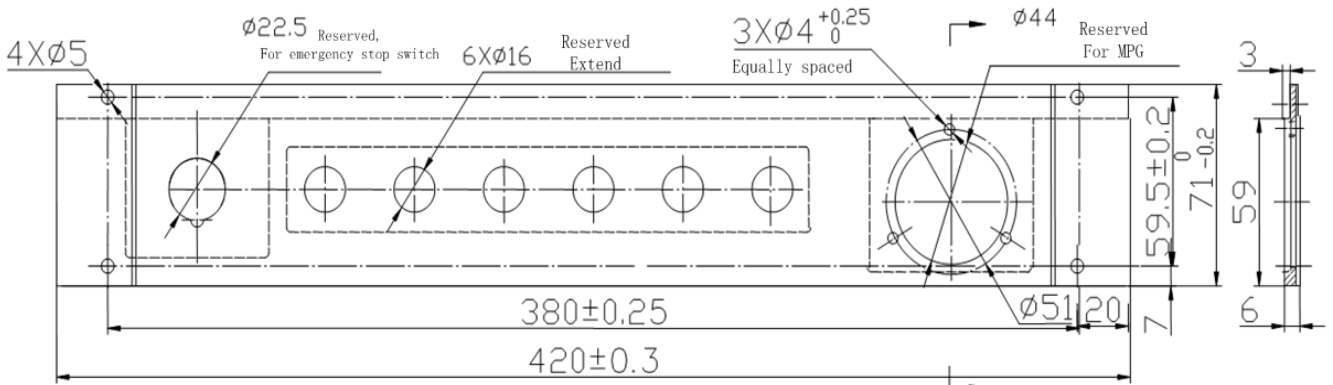

Fig. 1-4-2 GSK218MC-U1 additional panel

CHAPTER TWO CONNECTION BETWEEN EQUIPMENTS

2.1 Connection Diagram of External System

2.1.1 Layout of Interface Position

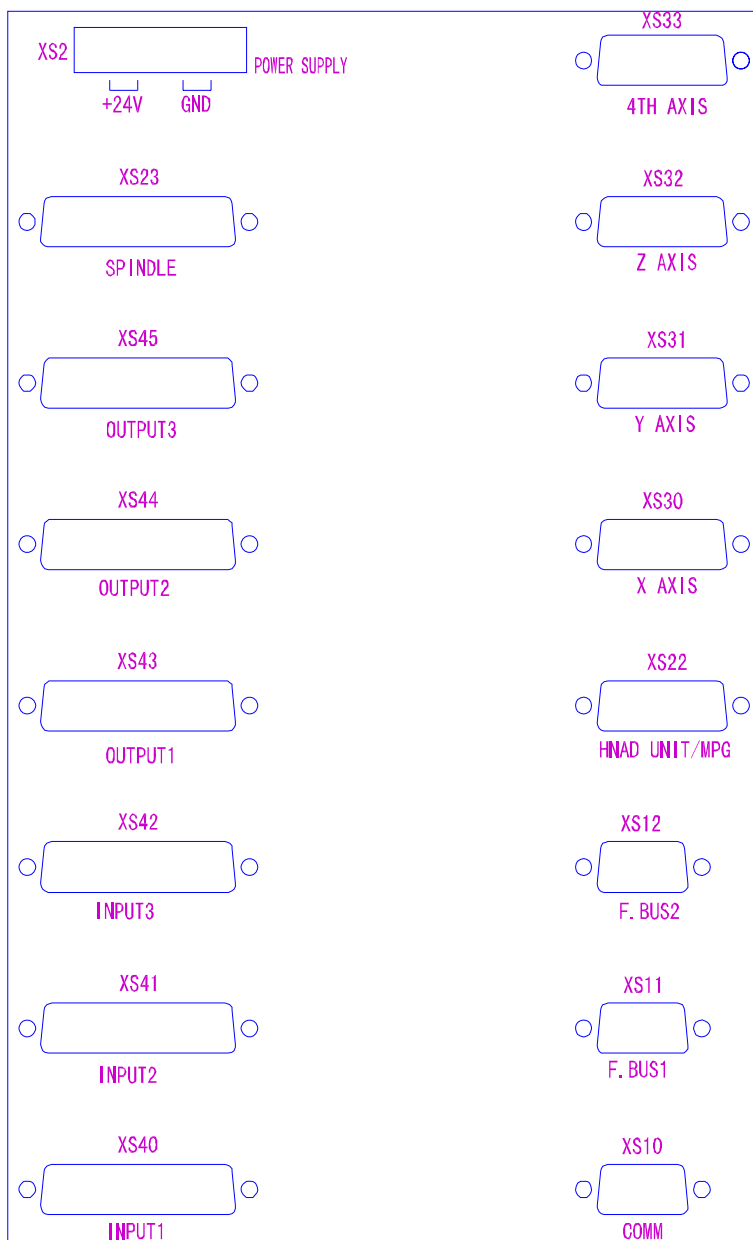

Fig. 218MC, 218MC-H and 218MC-V interface figure

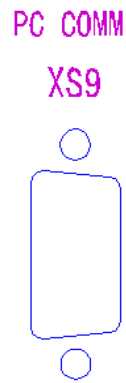

Fig. 2-1-1-2 PC communication interface of the 218MC-U1

The RS232-C series interface of the 218MC-U1 is placed at back of the host machine. The 218MC, 218MC-H and 218MC-V are placed at the front of the host, and the rest of the interfaces of the 218MC series are consistent.

2.1.2 Pulse Servo Connection Schematic

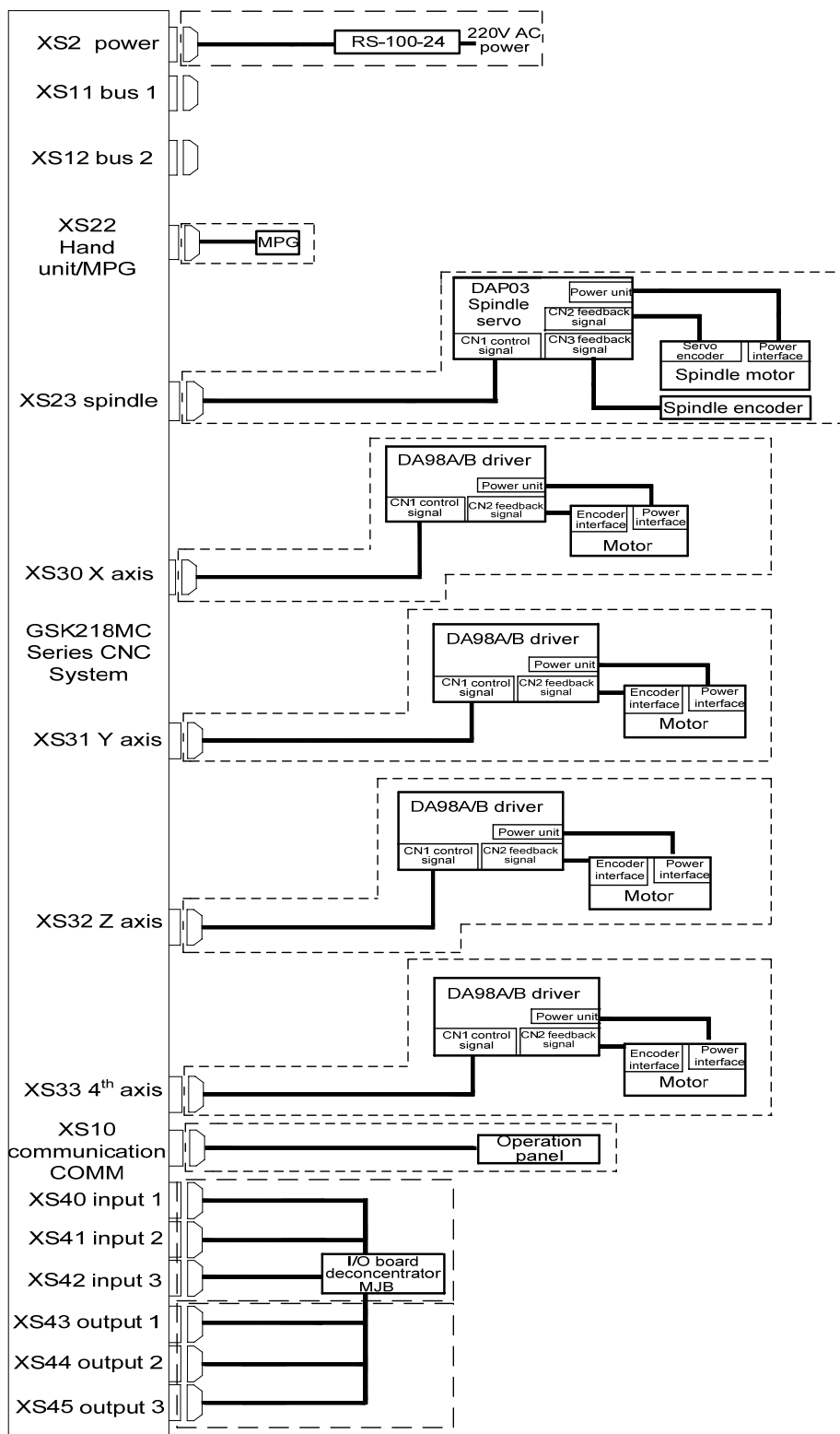

Fig. 2-1-2-1

2.1.3 Bus Servo Connection Schematic

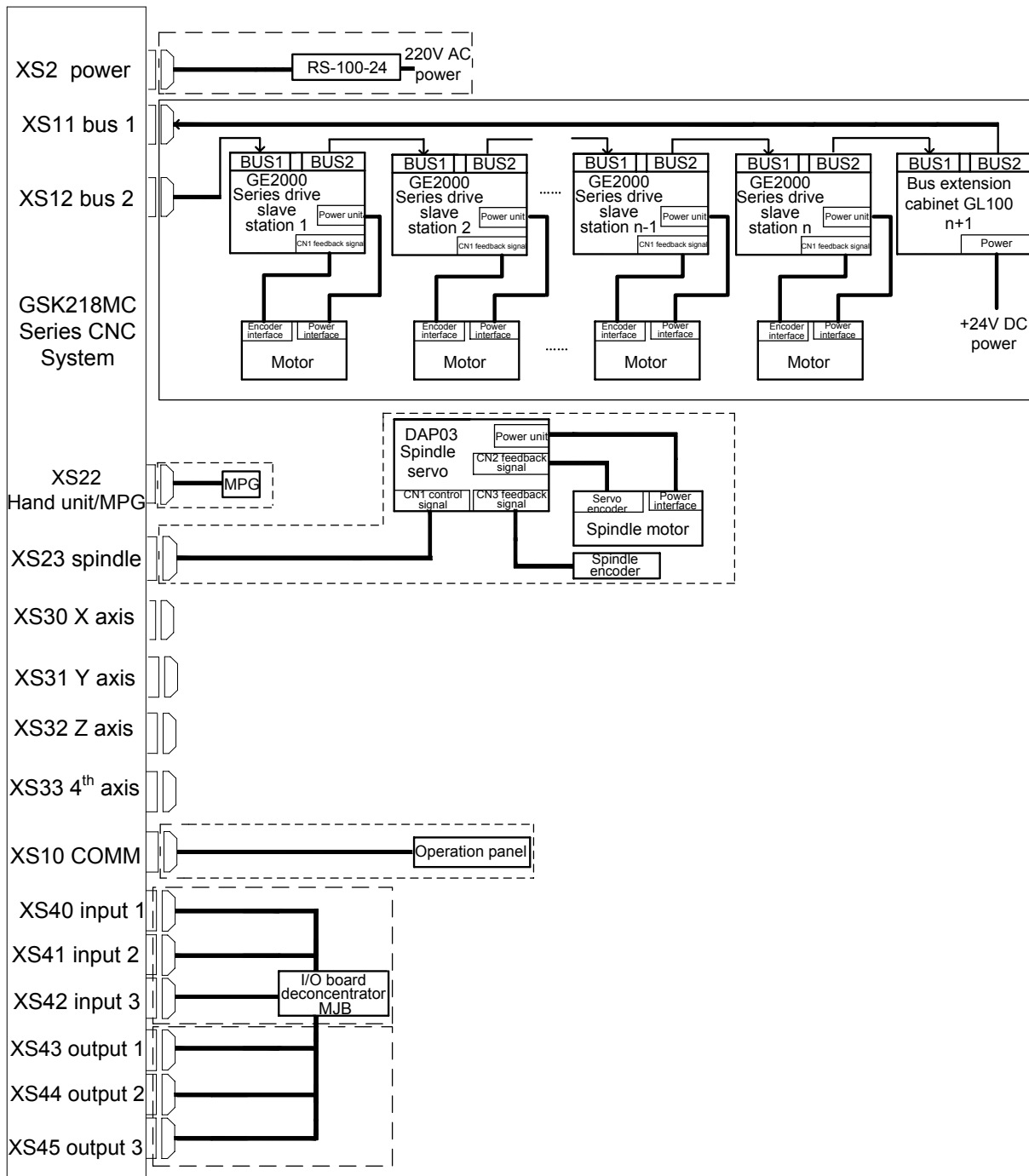

Fig. 2-1-3-1

System CNC bus interface 2 (that is, the XS12 interface of the CNC) that connects to the servo BUS1 (GT17 interface) is the slave station 1 (the 1st axis). The servo from the BUS2 (GT17 interface) to the system bus interface 1 (the XS11 interface of the CNC) is regarded as the last axis.

2.1.4 Five-Linkage Servo Connection Schematic Using Bus Technology

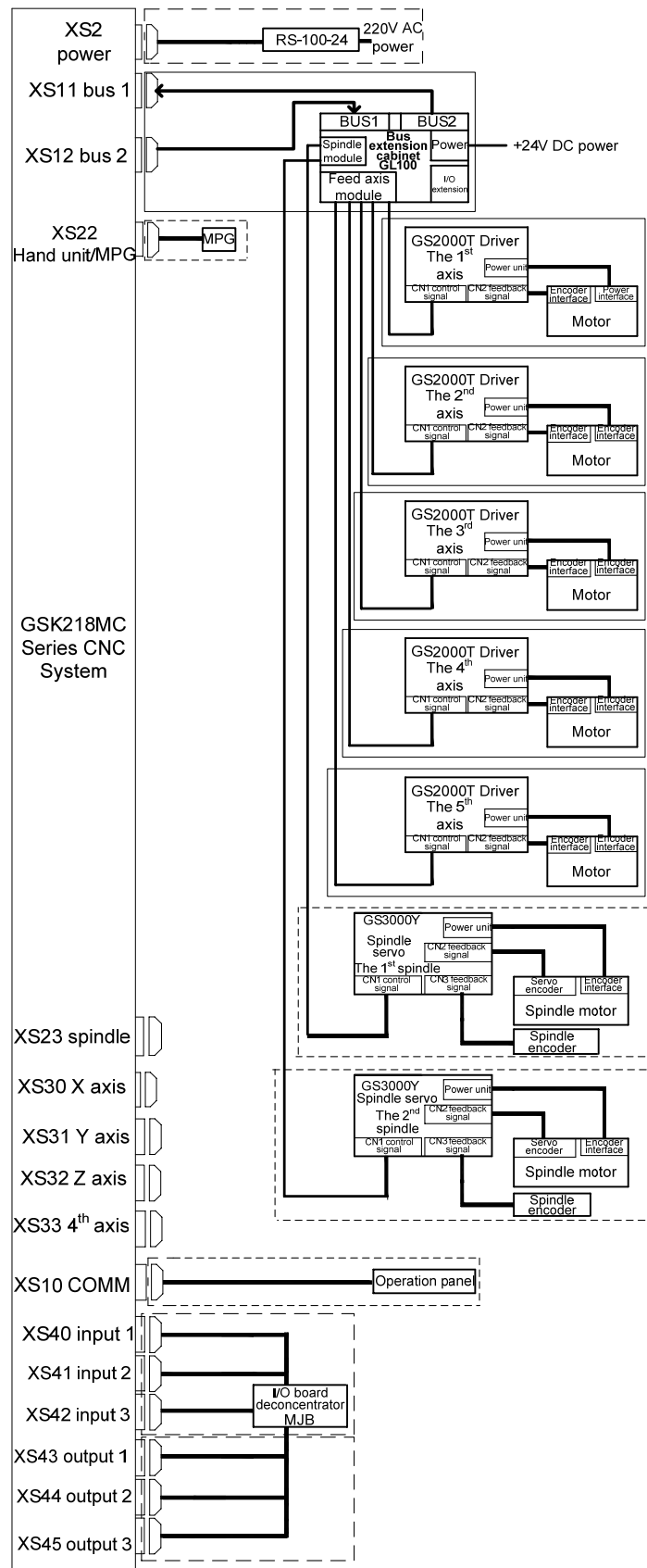

Fig. 2-1-4-1

2.2 Connection Between System and Drive Unit

The interfaces with the drive unit include XS30 (X axis), XS31 (Y axis), XS32 (Z axis) and XS33 (the 4th axis).

2.2.1 System Interface Figure

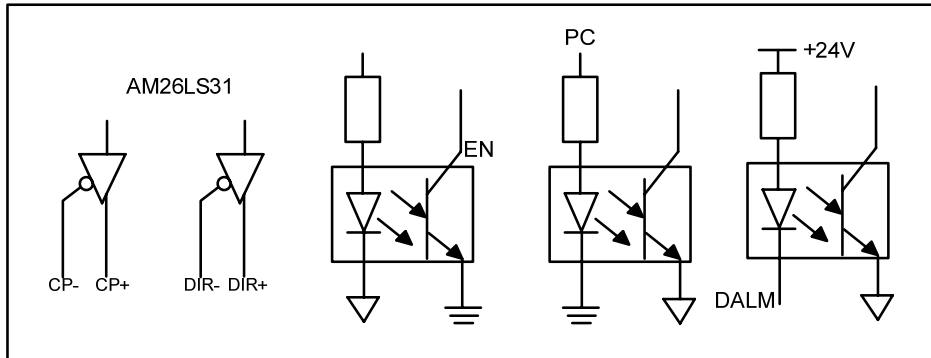

Fig. 2-2-1-1

2.2.2 Interface Signal List

XS30: DB15 female (X axis)

1	XCP+	9	XCP-
2	XDIR+	10	XDIR-
3	XPC	11	0V
4	+24V	12	+5V
5	XDALM	13	+5V
6		14	0V
7	XEN	15	0V
8	0V		

XS31: DB15 female (Y axis)

1	YCP+	9	YCP-
2	YDIR+	10	YDIR-
3	YPC	11	0V
4	+24V	12	+5V
5	YDALM	13	+5V
6		14	0V
7	YEN	15	0V
8	0V		

XS32: DB15 female (Z axis)

1	ZCP+	9	ZCP-
2	ZDIR+	10	ZDIR-
3	ZPC	11	0V
4	+24V	12	+5V
5	ZDALM	13	+5V
6		14	0V
7	ZEN	15	0V
8	0V		

XS33: DB15 female (4th axis)

1	4CP+	9	4CP-
2	4DIR+	10	4DIR-
3	4PC	11	0V
4	+24V	12	+5V
5	4DALM	13	+5V
6		14	0V
7	4EN	15	0V
8	0V		

Fig. 2-2-2-1

2.2.3 Signal Explanation

1. The pulse movement code signals

XCP+, XCP-, YCP+, YCP-, ZCP+, ZCP-, 4CP+ and 4CP- are code pulse signals, XDIR+, XDIR-, YDIR+, YDIR-, ZDIR+, ZDIR-, 4DIR+ and 4DIR- are movement direction signal, and the signals of two groups are difference output.

The circuit diagram is shown as below:

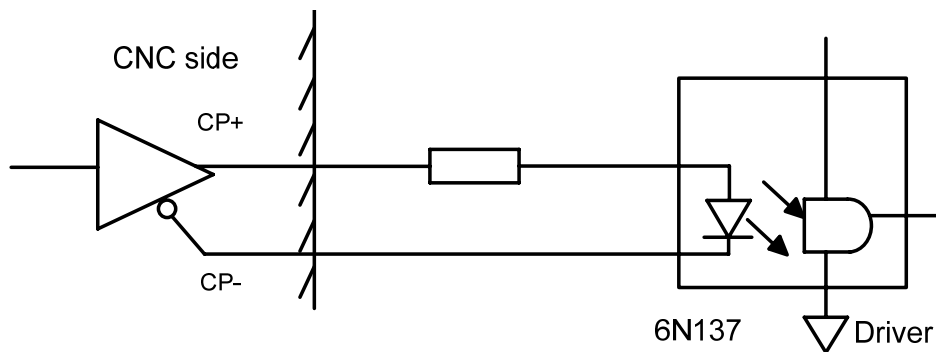

Fig. 2-2-3-1

2. The drive unit alarm signal ALM (input)

The receive method of this signal at the system side is shown below. Whether the high level or the low is valid can be set by the bit parameter #19 (The high or the low level should comply with the drive unit.)

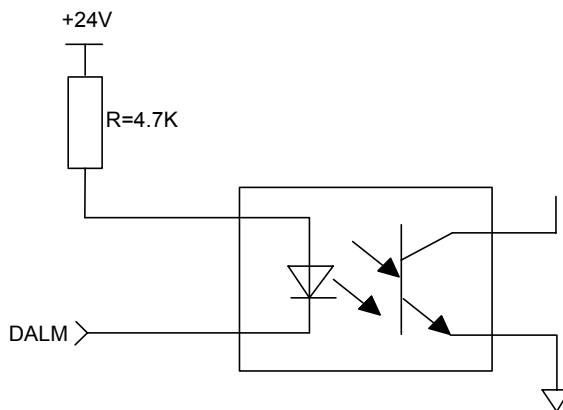

Fig. 2-2-3-2

3. Ready signal EN of CNC system (contact output)

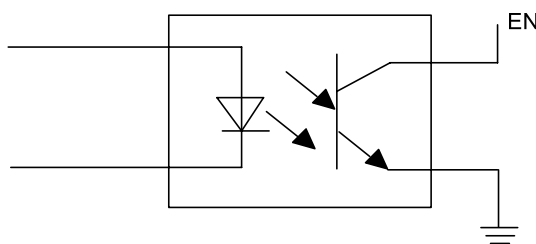

Fig. 2-2-3-3

4. Signal PC using in the reference position return

The system supports the +24V zero return and +5V zero return; the received circuit of this signal at the system side is shown below:

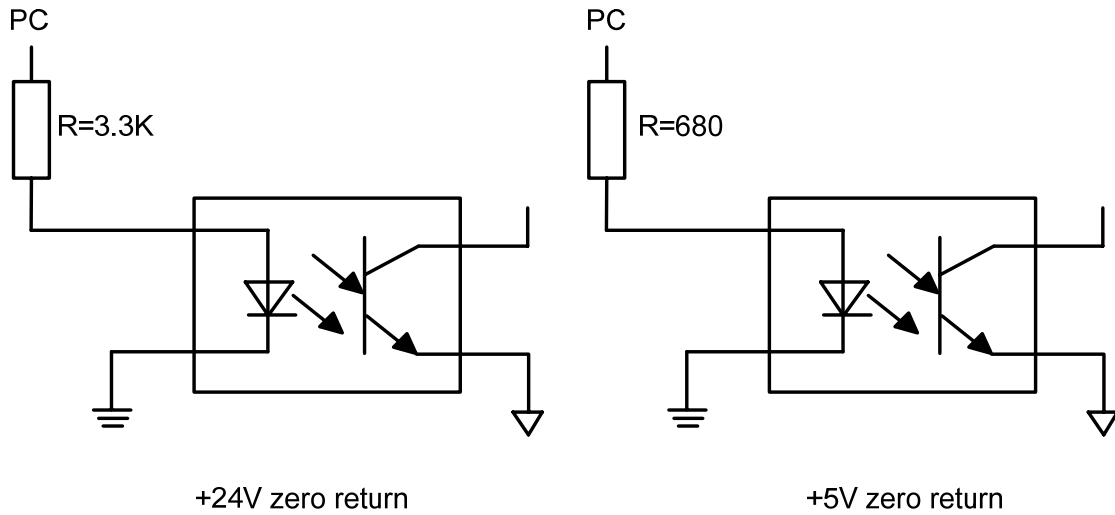

Fig. 2-2-3-4

The wave of PC signals provided by the user is shown as the following figure:

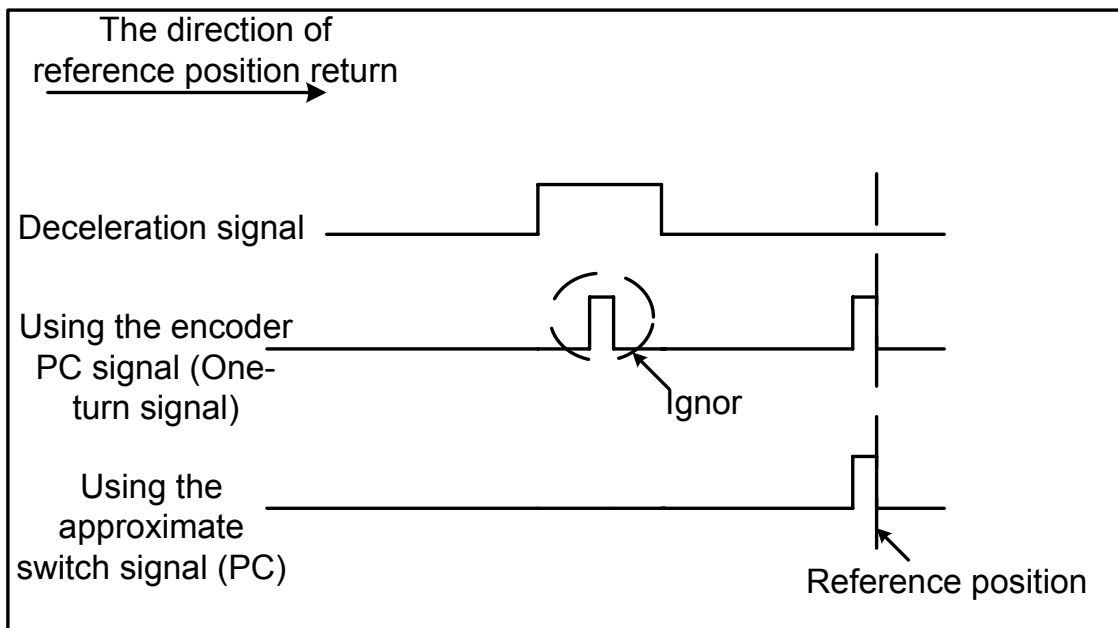

Fig. 2-2-3-5

2.2.4 Cable Connection Figure

1. The cable connection when the GSK218MC connects with the DY3 series drive unit

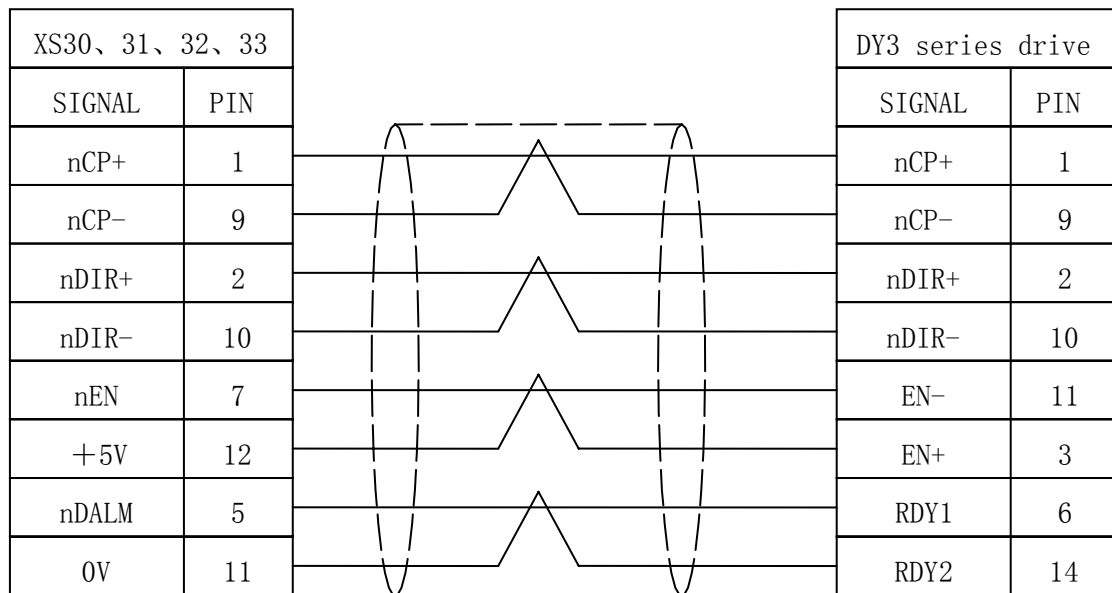

Fig. 2-2-4-1

2. The cable connection when the GSK218MC connects with the DA98 series servo drive unit

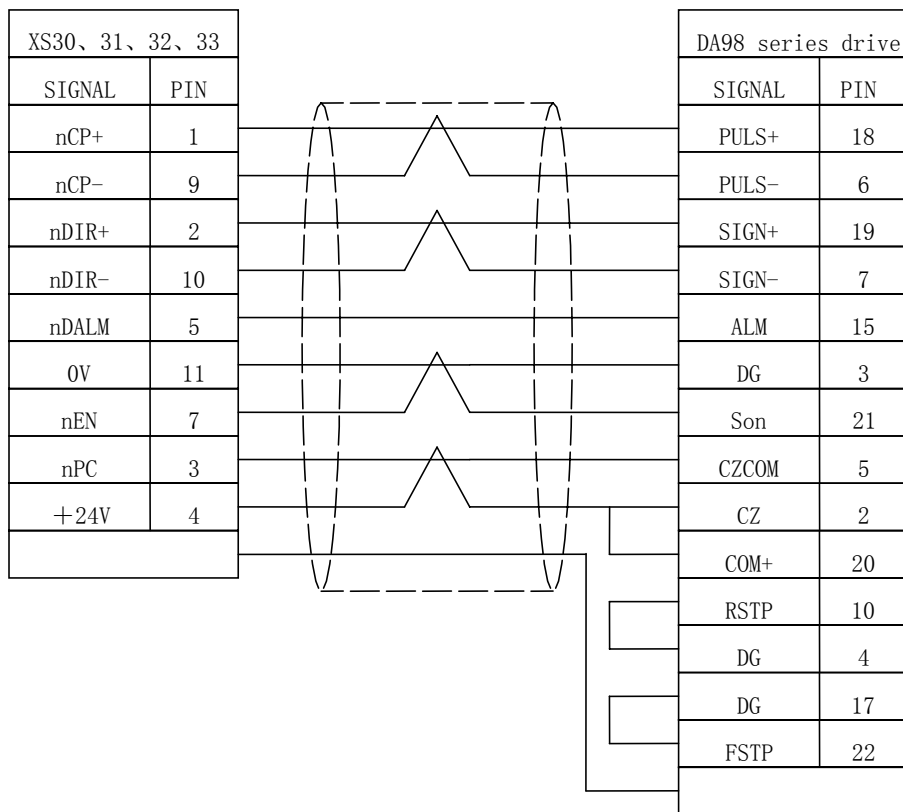

Fig. 2-2-4-2

3. The cable connection when the GSK218MC connects with the DA98B series servo drive unit

Volume IV
Installation & Connection

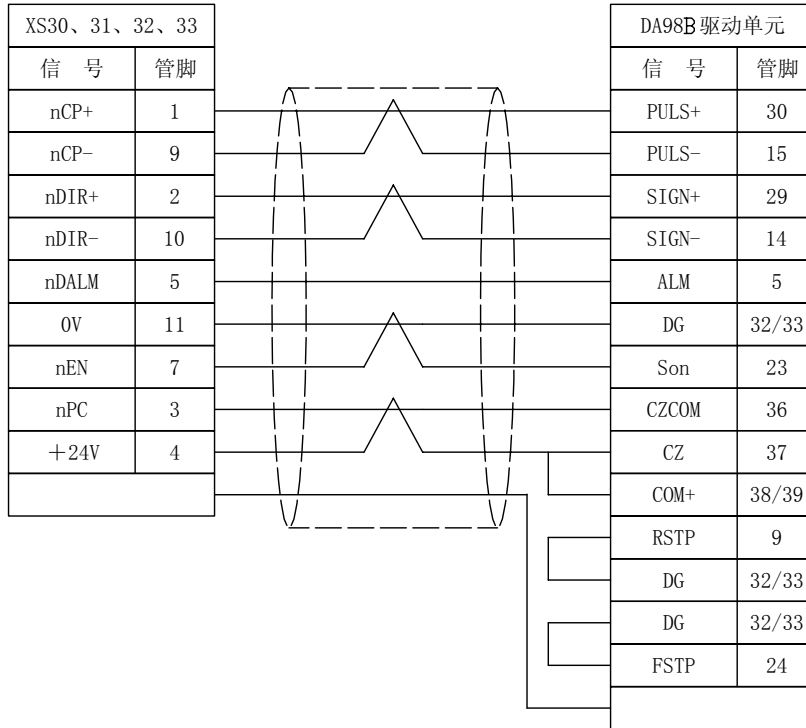

Fig. 2-2-4-3

4. The cable connection when the GSK218MC connects with the GS2000 series economy servo drive unit

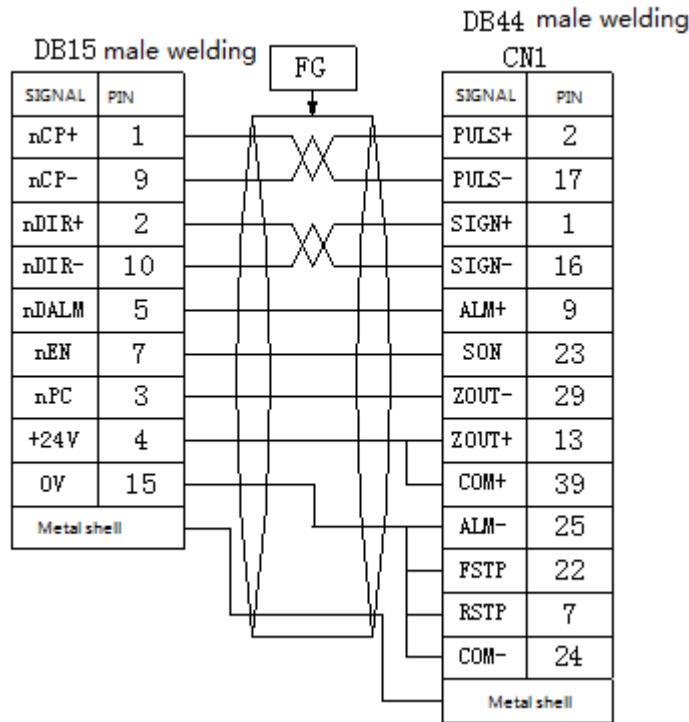

Fig. 2-2-4-4

2.2.5 GSK-LINK Cable Connection Figure

CNC side bus 1 interface

signal XS11:(DB9 female seat)

1	NULL	6	BTX+
2	NULL	7	BTX-
3	NULL	8	空
4	BRX-	9	空
5	BRX+		

Interface signal explanation:

- 1)BTX: Bus differential data send
- 2)BRX: Bus differential data receive
- 3)GND: signal ground

CNC side bus 2 interface

signal XS12:(DB9 male seat)

1	NULL	6	ATX-
2	NULL	7	ATX+
3	NULL	8	NULL
4	ARX+	9	NULL
5	ARX-		

Interface signal explanation:

- 1)ATX: Bus differential data send
- 2)ARX: Bus differential data receive
- 3)GND: signal ground

Fig. 2-2-5-1 CNC terminal bus interface definition

GT17 interface converts into DB9 female interface						
GT17VS-8DS-HU (Line-imposing) GE2000 Series BUS1			Connection	DB9 female (Welding cable) CNC XS12		
Series No.	Signal name	Reticle color		Series No.	Signal name	Reticle color
1	RX- (BI_DA-)	Orange white		7	RX- (BI_DA-)	Green white
2	RX+ (BI_DA+)	Orange		6	RX+ (BI_DA+)	Green
3	TX- (BI_DB-)	Green white		4	TX- (BI_DB-)	Orange white
4	TX+ (BI_DB+)	Green		5	TX+ (BI_DB+)	Orange
5	Reserved (BI_DC-)	Blue white		8	Reserved (BI_DC-)	Brown white
6	Reserved (BI_DC+)	Blue		9	Reserved (BI_DC+)	Brown
7	Reserved (BI_DD-)	Brown white		1	Reserved (BI_DD-)	Blue white
8	Reserved (BI_DD+)	Brown		2	Reserved (BI_DD+)	Blue

Fig. 2-2-5-2 The connection between the bus interface 2 of the CNC terminal and driver

GT17 interface converts into DB9 male interface						
GT17VS-8DS-HU(Line-imposing)			Connection	DB9 male (Welding cable)		
Series No.	Signal name	Reticle color		Series No.	Signal name	Reticle color
1	RX- (BI_DA-)	Orange white		6	RX- (BI_DA-)	Green white
2	RX+ (BI_DA+)	Orange		7	RX+ (BI_DA+)	Green
3	TX- (BI_DB-)	Green white		5	TX- (BI_DB-)	Orange white
4	TX+ (BI_DB+)	Green		4	TX+ (BI_DB+)	Orange
5	Reserved (BI_DC-)	Blue white		8	Reserved (BI_DC-)	Brown white
6	Reserved (BI_DC+)	Blue		9	Reserved (BI_DC+)	Brown
7	Reserved (BI_DD-)	Brown white		1	Reserved (BI_DD-)	Blue white
8	Reserved (BI_DD+)	Brown		2	Reserved (BI_DD+)	Blue

Fig. 2-2-5-3 The connection between the bus interface 1 of the CNC terminal and driver

GSK_LINK Industry Ethernet Cable (GT17 interface)						
GT17VS-8DS-HU (Line-imposing) GE2000 Series BUS2			Connection	GT17VS-8DS-HU(Line-imposing) GE2000 Series BUS1		
Series No.	Signal name	Reticle color		Series No.	Signal name	Reticle color
1	RX- (BI_DA-)	Orange white		1	RX- (BI_DA-)	Green white
2	RX+ (BI_DA+)	Orange		2	RX+ (BI_DA+)	Green
3	TX- (BI_DB-)	Green white		3	TX- (BI_DB-)	Orange white
4	TX+ (BI_DB+)	Green		4	TX+ (BI_DB+)	Orange
5	Reserved (BI_DC-)	Blue white		5	Reserved (BI_DC-)	Brown white
6	Reserved (BI_DC+)	Blue		6	Reserved (BI_DC+)	Brown
7	Reserved (BI_DD-)	Brown white		7	Reserved (BI_DD-)	Blue white
8	Reserved (BI_DD+)	Brown		8	Reserved (BI_DD+)	Blue

Fig. 2-2-5-4 The connection between drivers

2.2.6 External Wiring Figure of GL100 Bus Extension Module

There are 4 function modules of the GL100 bus extension cabinet: the power module is used for the power input of the extension cabinet; the feed axis module is used for the measure feedback equipment of the pulse multi-feed axis extension and optical-grating connection, etc.; the spindle module is used for the spindle extension; I/O module can be used for extending the I/O point.

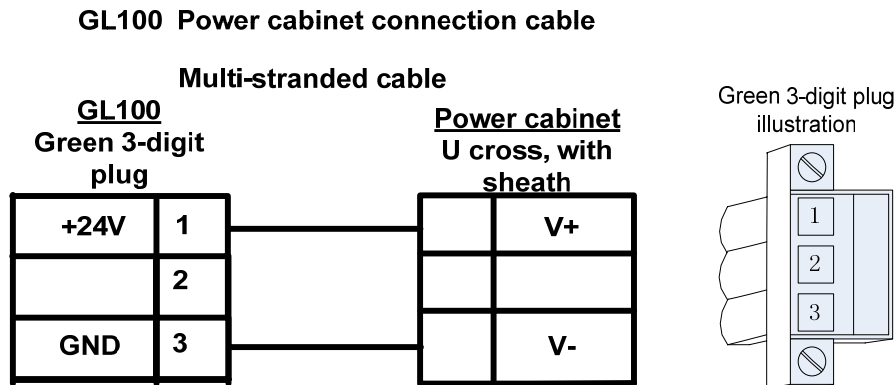

Fig. 2-2-6-1 Power input cable

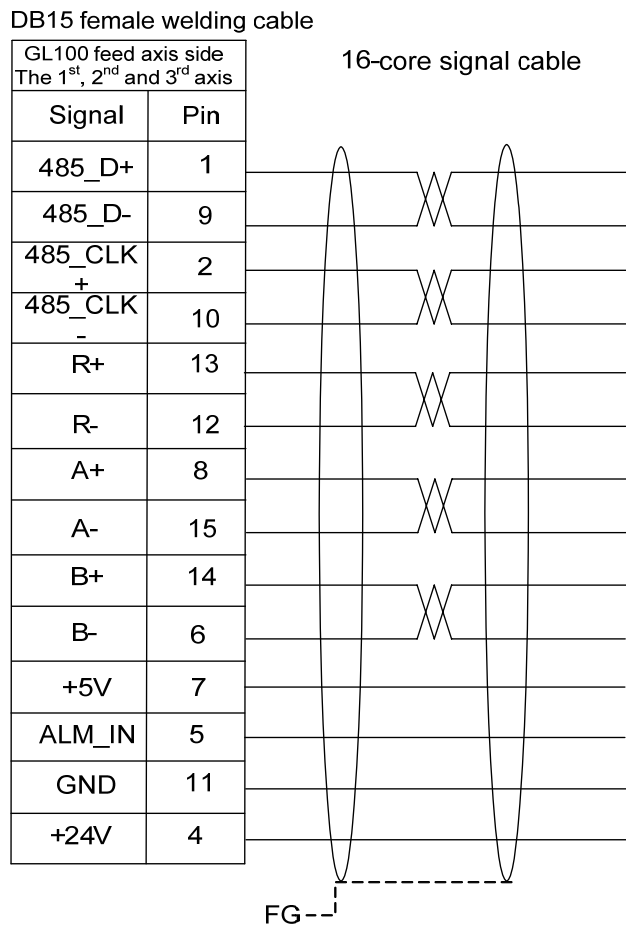

Fig. 2-2-6-2 The feedback encoder signal cable for connecting the optical-grating, etc.

The cable production method of the feed axis module is identical with the pulse driver; refer to

the Section 2.2.4 Cable Connection Figure for the feed axis driver of each axis.

Refer to the Section 2.5.3 Cable Connection Figure for the spindle driver of each type about the cable production method of the spindle module.

X0(Input1): Socket

0	user-d
1	user-d
2	user-d
3	user-d
4	user-d
5	user-d
6	user-d
7	user-d
GND	GND
24V	+24V

X1(Input2): Socket

0	user-d
1	user-d
2	user-d
3	user-d
4	user-d
5	user-d
6	user-d
7	user-d
GND	GND
24V	+24V

X2(Input3): Socket

0	user-d
1	user-d
2	user-d
3	user-d
4	user-d
5	user-d
6	user-d
7	user-d
GND	GND
24V	+24V

X3(Input4): Socket

0	user-d
1	user-d
2	user-d
3	user-d
4	user-d
5	user-d
6	user-d
7	user-d
GND	GND
24V	+24V

Y0(Output1): Socket

0	user-d
1	user-d
2	user-d
3	user-d
4	user-d
5	user-d
6	user-d
7	user-d
GND	GND
24V	+24V

Y1(Output2): Socket

0	user-d
1	user-d
2	user-d
3	user-d
4	user-d
5	user-d
6	user-d
7	user-d
GND	GND
24V	+24V

Y2(Output3): Socket

0	user-d
1	user-d
2	user-d
3	user-d
4	user-d
5	user-d
6	user-d
7	user-d
GND	GND
24V	+24V

Y3(Output4): Socket

0	user-d
1	user-d
2	user-d
3	user-d
4	user-d
5	user-d
6	user-d
7	user-d
GND	GND
24V	+24V

Fig. 2-2-6-3 The I/O module definition figure of the GL100 bus extension cabinet

2.3 RS232 Standard Series Interfaces

GSK218MC CNC system can be performed the communication (GSK218MC communication software must be equipped here) with the RS232-C series interface and the PC machine. Refer to the following connection figure:

The connection of the cable shows that the shielding cable connects with the GND, and the metal shell does not connect with the shielding cable:

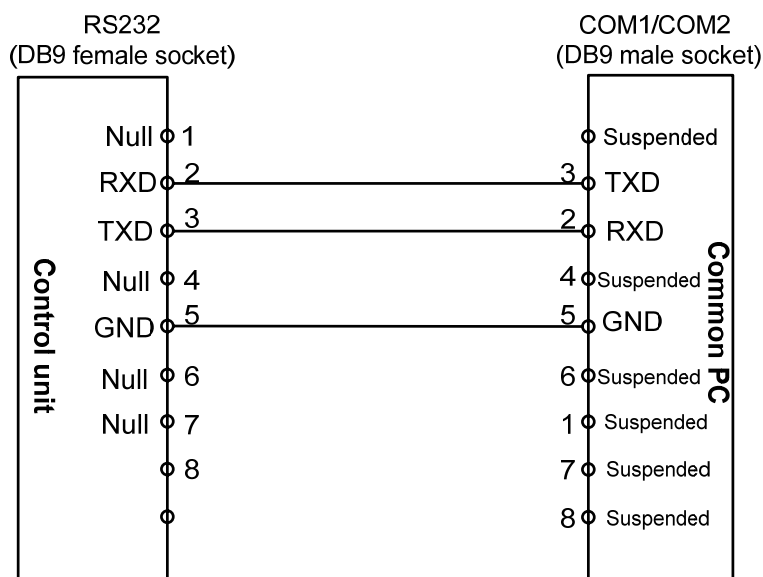

Fig. 2-3-1

2.4 Connection of MPG/Hand Unit

2.4.1 Interface Signal Figure

218MC system can be equipped the MPG or hand unit with difference or non-difference type, the interface signal is shown below:

XS22: (DB26 female plug)

1	HB+	10	GND	19	LED
2	HB-	11		20	
3	HA+	12		21	VCOM
4	HA-	13		22	ESP2
5	HX	14		23	HY
6	HZ	15	VDD5	24	HU
7	H ₋	16		25	H*1
8	H*10	17		26	H*100
9	ESP1	18			

Fig. 2-4-1-1

2.4.2 Explanation of Interface Signal

HA+, HA-, HB+ and HB-: It matches with the difference MPG or hand unit pulse signal (HA+, HB+ connects with +5V; HA- with the A of the MPG; and the HB- with the B of the MPG when it

equips with the non-difference MPG or Hand unit);

ESP1, ESP2: Hand unit ESP signal;

HX, HY, HZ, H4 and H5: They are respectively the axis selection signals of X, Y, Z, 4th and 5th;

H*1, H*10 and H*100: They are respectively the override signals of MPG pulse equivalent;

VCOM: Common port of Hand unit.

The connection diagram of 218MC with the internal MPG is shown below:

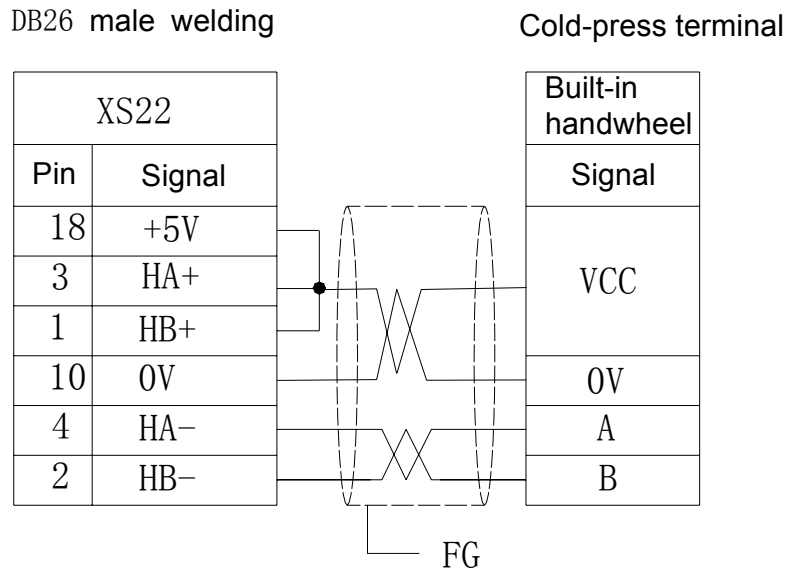

Fig. 2-4-2-1

The connection diagram of GSK218MC connecting with the difference type (L):

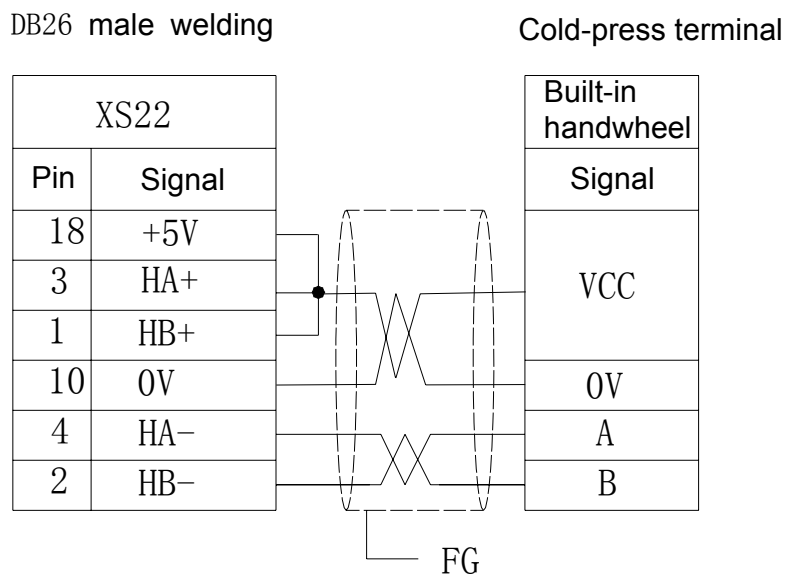

Fig. 2-4-2-2

The connection diagram of GSK218MC connecting with the voltage type (E) Hand unit

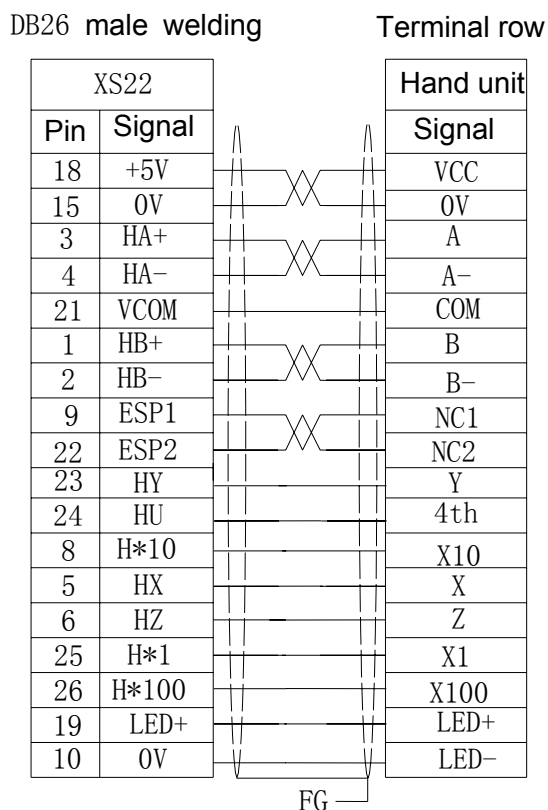

Fig. 2-4-2-3

2.5 Connection of Spindle Unit

2.5.1 Interface Signal Table

The system interface is DB44 pin socket, and its pin definitions are shown below:

XS23: (DB44 female plug)

1	PA-	16	PA+	31	GND
2	PB-	17	PB+	32	GND
3	PZ-	18	PZ+	33	SIGN+
4	ZOUT-	19	ZOUT+	34	SIGN-
5	SAR/PAR	20	ZSP	35	COM-
6	SECT	21	COIN	36	COM-
7	ALM	22	RDY	37	COM+
8	ARST	23	COM-	38	COM+
9	SFR	24	SON	39	COM+
10	SPO	25	SRV	40	SP1
11	STAO	26	SP2	41	SECO
12	VP	27	ZSL	42	PURS+
13	GE0	28	PULS-	43	GE1
14	VCMD+	29	AGND	44	VPO
15	VCMD-	30	AGND		

Fig. 2-5-1-1

2.5.2 Explanation of Interface Signal

- 1) VCMD+, VCMD-: Analog command input 0~10V or -10V~ +10V (It is determined by parameter);
- 2) Spindle output signal: SON spindle enabling, SFR spindle positive, SRV spindle negative, STAO spindle orientation, SPO positioning selection and VP velocity/position shifting;
- 3) Spindle input signal: SAR spindle velocity arrival, ZSP spindle zero velocity inspection, COIN spindle positioning completion, AxisALM alarm input and VPO velocity/position shifting completion;
- 4) PA+, PA-, PB+, PB-, PZ+ and PZ-: The pulse signal of the spindle encoder;
- 5) PULS+, PULS-: Position method pulse command output;
- 6) SIGN+, SIGN-: Position method direction command output;

2.5.3 Cable Connection Figure

1. The interface connection of the system matching with the DAP03 spindle driver control cable:

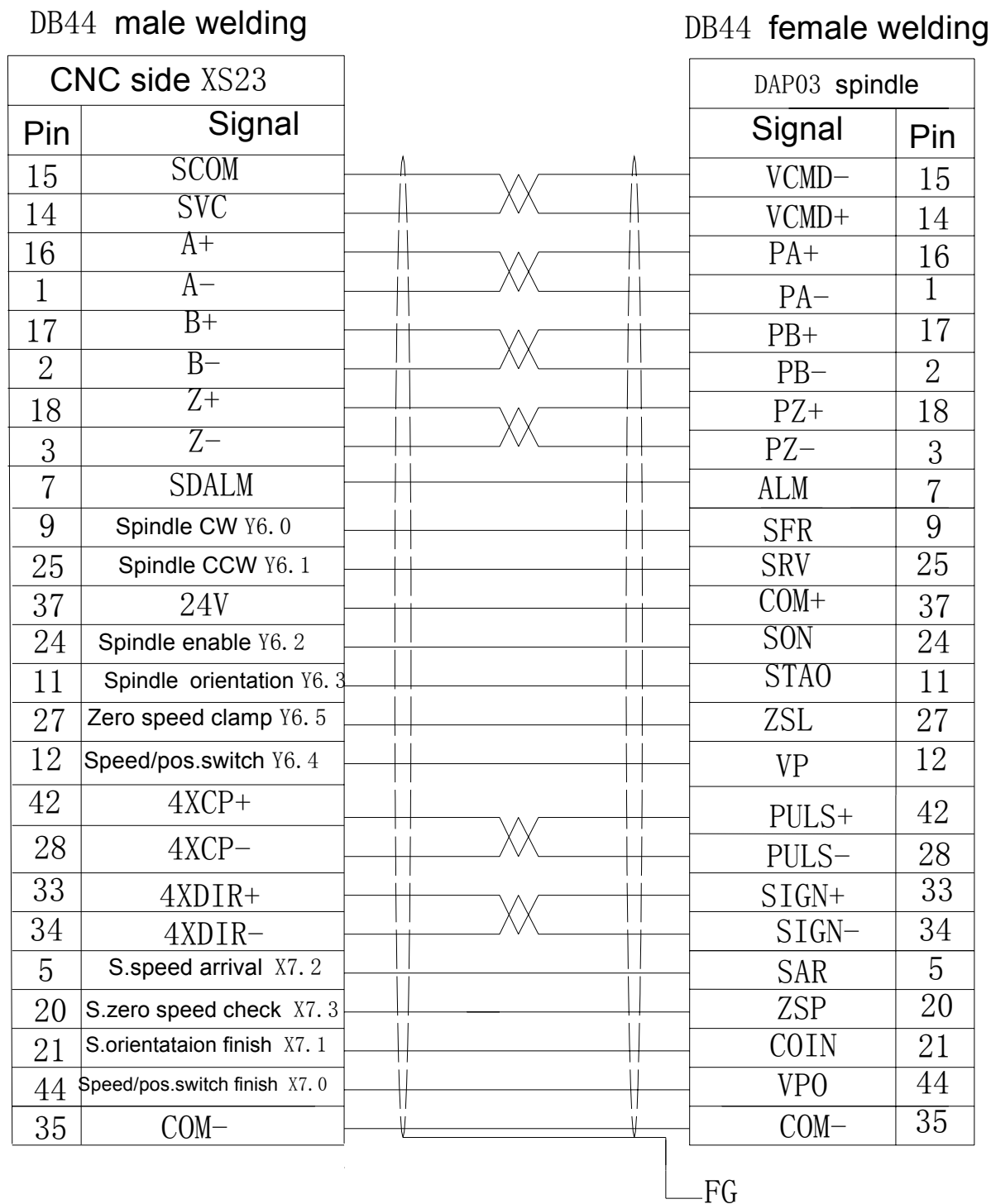

Fig. 2-5-3-1

2. The interface wiring of the system matching with GS3000 series economy spindle driver:

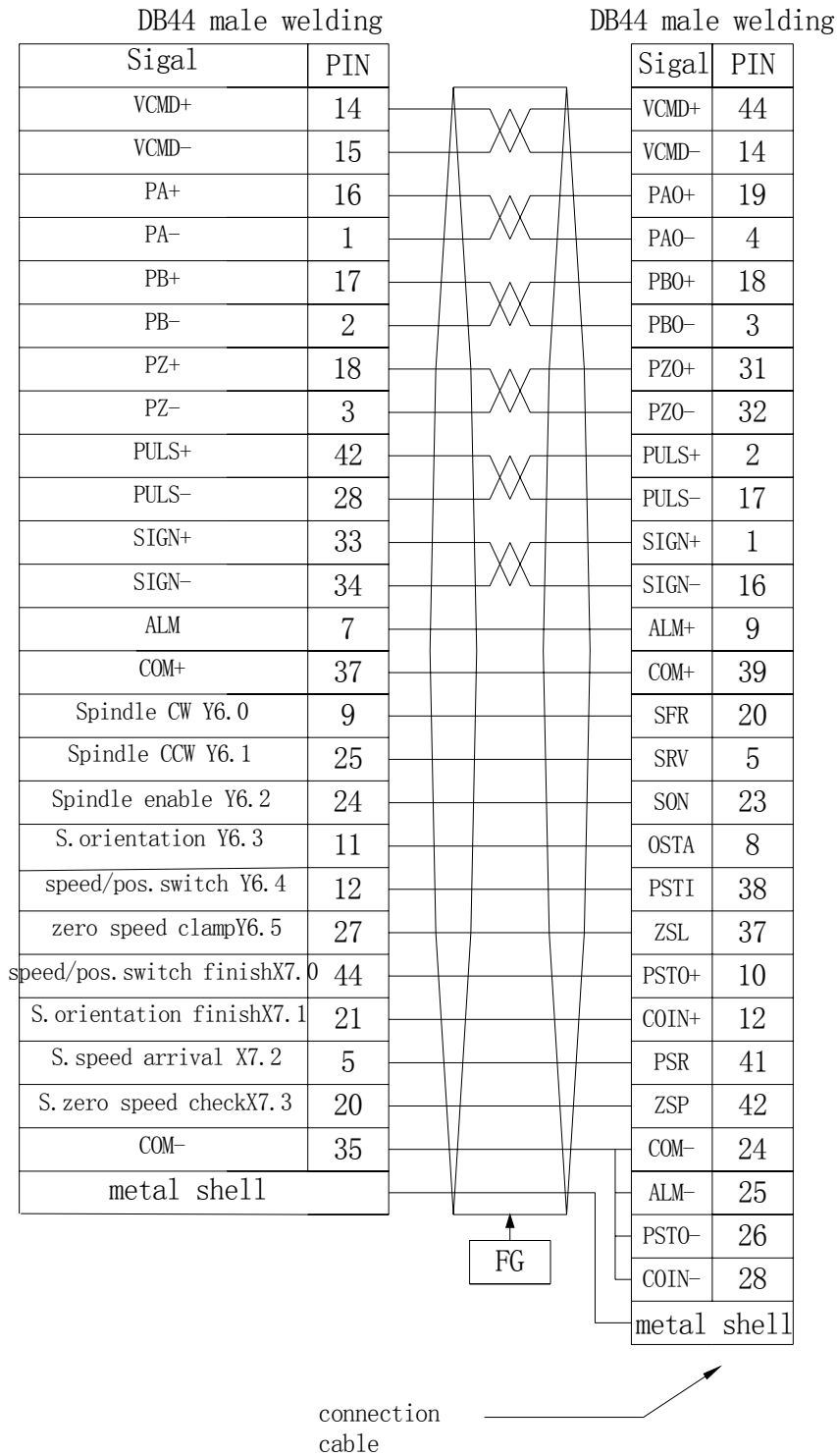

Fig. 2-5-3-2

2.6 System Power Interface

The input voltage of the system is +24V. And the power supply interface is as follows:

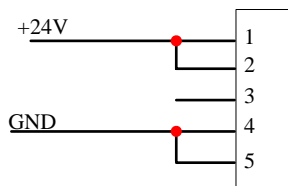

Fig. 2-6-1

2.7 External Power Control Interface

The external control interface on the 218MC-H and 218MC-V system operation panel is as follows:

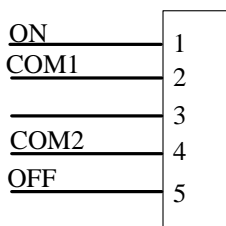

Fig. 2-7-1

System power ON: ON and COM1 are the ends of the normal-opened (NORM) switch.

System power OFF: ON and COM2 are the ends of the normal-closed (NORM) switch.

Note: The switch power should be directly connected with the DC 24V, instead of using the AC 110V or 220V; otherwise, the system will be burnt.

2.8 Connection of Communication Cable

The communication cable should be used the shielding cable.

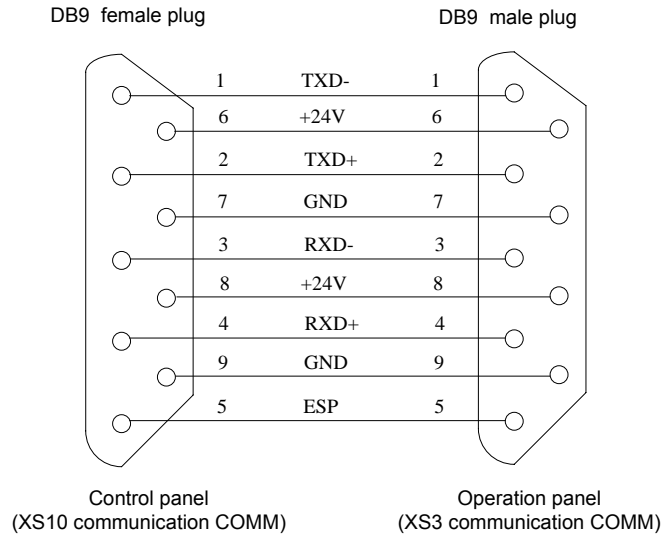

Fig. 2-8-1

CHAPTER THREE I/O INTERFACE OF MACHINE CONTROL

3.1 Interface Signal Table

XS40 (input 1): DB25 male plug

1	IN00	14	IN01
2	IN02	15	IN03
3	COM	16	COM
4	+24V	17	IN04
5	IN05	18	IN06
6	IN07	19	COM
7	COM	20	+24V
8	IN08	21	IN09
9	IN10	22	IN11
10	COM	23	COM
11	+24V	24	IN12
12	IN13	25	IN14
13	IN15		

XS41 (input 2): DB25 male plug

1	IN16	14	IN17
2	IN18	15	IN19
3	COM	16	COM
4	+24V	17	IN20
5	IN21	18	IN22
6	IN23	19	COM
7	COM	20	+24V
8	IN24	21	IN25
9	IN26	22	IN27
10	COM	23	COM
11	+24V	24	IN28
12	IN29	25	IN30
13	IN31		

XS42 (input 3): DB25 male plug

1	IN32	14	IN33
2	IN34	15	IN35
3	COM	16	COM
4	+24V	17	IN36
5	IN37	18	IN38
6	IN39	19	COM
7	COM	20	+24V
8	IN40	21	IN41
9	IN42	22	IN43
10	COM	23	COM
11	+24V	24	IN44
12	IN45	25	IN46
13	IN47		

XS43: output 1 DB25 female plug

1	D000	14	D001
2	D002	15	D003
3	COM	16	+24V
4	+24V	17	D004
5	D005	18	D006
6	D007	19	COM
7	+24V	20	+24V
8	D008	21	D009
9	D010	22	D011
10	COM	23	+24V
11	+24V	24	D012
12	D013	25	D014
13	D015		

XS44: output 2 DB25 female plug

1	D016	14	D017
2	D018	15	D019
3	COM	16	+24V
4	+24V	17	D020
5	D021	18	D022
6	D023	19	COM
7	+24V	20	+24V
8	D024	21	D025
9	D026	22	D027
10	COM	23	+24V
11	+24V	24	D028
12	D029	25	D030
13	D031		

XS45: output 3 DB25 female plug

1	D032	14	D033
2	D034	15	D035
3	COM	16	+24V
4	+24V	17	D036
5	D037	18	D038
6	D039	19	COM
7	+24V	20	+24V
8	D040	21	D041
9	D042	22	D043
10	COM	23	+24V
11	+24V	24	D044
12	D045	25	D046
13	D047		

cFig. 3-1-1

Wherein, XS40, XS41 and XS42 are input interfaces (DB25 male); XS43, XS44 and XS45 are output interfaces (DB25 female).

3.2 Interface Input

3.2.1 Interface Circuit Input

The DC input signal is the one from machine to CNC where is come from the button of the machine side, limit switch and contactor of relay, etc.

a) The contactor of the machine side should be suitable for the following conditions:

Contactor capacity: Above DC30V, 16mA

The leakage current among the contacts during the open-circuit: below 1mA (voltage 26.4V).

The potential drop among the contracts during the closed-circuit: below 2V (Current 8.5mA, the potential drop of the cable included)

b) The signal loop of this signal is depicted in Fig. 3-2-1-1

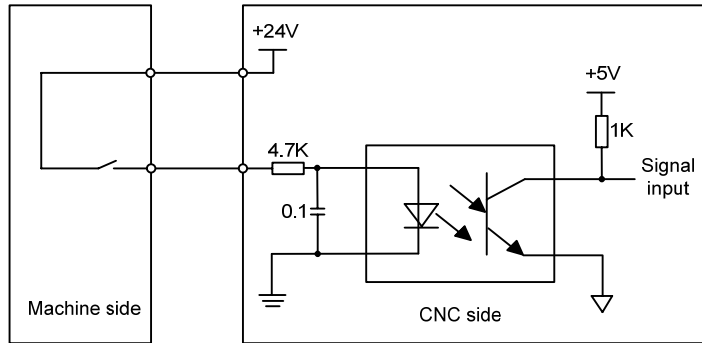

Fig. 3-2-1-1

3.2.2 Interface Circuit of Hand Unit

a) The Hand unit is only received the 0V Level input instead of the 24V input.

b) The axis selection and override signal loop are shown in the Fig. 3-2-2-1

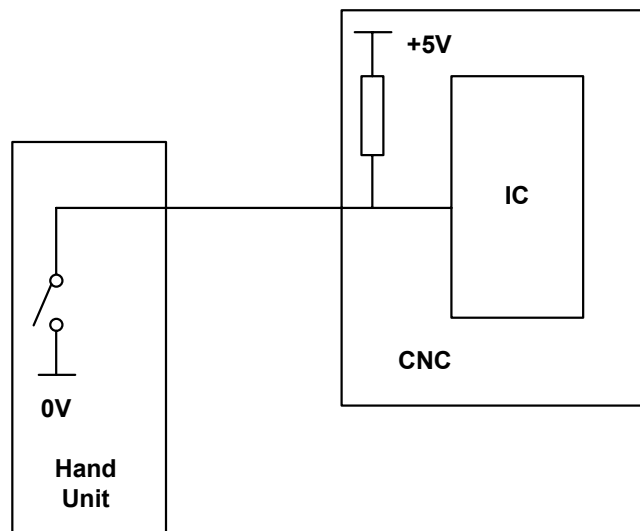

Fig. 3-2-2-1

3.2.3 Interface Definition of Signal Input

The definition of each pin for the input interface is shown in the following table:

Table 3-2-3-1

Add.	Signal interface	Interface pin	Definition		Contactor selection
			Cone tool-magazine	Disc tool-magazine	
X000.0	XS40	1	+ stroke limit signal along with the 1 st axis		NC contactor
X000.1	XS40	14	- stroke limit signal along with the 1 st axis		NC contactor
X000.2	XS40	2	+ stroke limit signal along with the 2 nd axis		NC contactor
X000.3	XS40	15	- stroke limit signal along with the 2 nd axis		NC contactor
X000.4	XS40	17	+ stroke limit signal along with the 3 rd axis		NC contactor
X000.5	XS40	5	- stroke limit signal along with the 3 rd axis		NC contactor
X000.6	XS40	18	+ stroke limit signal along with the 4 th axis		NC contactor
X000.7	XS40	6	- stroke limit signal along with the 4 th axis		NC contactor
X001.0	XS40	8	Zero-return deceleration signal along with the 1 st axis		NC contactor
X001.1	XS40	21	Zero-return deceleration signal along with the 2 nd axis		NC contactor
X001.2	XS40	9	Zero-return deceleration signal along with the 3 rd axis		NC contactor
X001.3	XS40	22	Zero-return deceleration signal along with the 4 th axis		NC contactor
X001.4	XS40	24	ESP switch (218MC integration)		NC contactor
X001.5	XS40	12	External cycle start		NORM contact
X001.6	XS40	25	External feed hold		NORM contact
X001.7	XS40	13	Lubrication pressure or grease level inspection		NORM contact
X002.0	XS41	1	Air-source air-pressure inspection		NORM contact
X002.1	XS41	14	Skip signal		NORM contact
X002.2	XS41	2	Index worktable releasing inspection		NORM

Add.	Signal interface	Interface pin	Definition		Contactor selection
			Cone tool-magazine	Disc tool-magazine	
					contact
X002.3	XS41	15	Index worktable clamping inspection		NORM contact
X002.4	XS41	17	External clamping/releasing control		NORM contact
X002.5	XS41	5	Releasing inspection		NORM contact
X002.6	XS41	18	Clamping inspection		NORM contact
X002.7	XS41	6	Spindle tool inspection switch	Undefined	Parameter specified
X003.0	XS41	8	Editing lock		NORM contact
X003.1	XS41	21	Operation lock		NORM contact
X003.2	XS41	9	Undefined	Manipulator brake signal	
X003.3	XS41	22	Undefined	Manipulator inspection signal with cutter	
X003.4	XS41	24	Undefined	Manipulator zero inspection signal	
X003.5	XS41	12	Undefined		
X003.6	XS41	25	Undefined		
X003.7	XS41	13	Undefined		
X004.0	XS42	1	Undefined		Parameter specified
X004.1	XS42	14	The 1 st gear spindle in-position		NORM contact
X004.2	XS42	2	The 2 nd gear spindle in-position		NORM contact
X004.3	XS42	15	The 3 rd gear spindle in-position		NORM contact
X004.4	XS42	17	Undefined		
X004.5	XS42	5	Safety door inspection switch		NORM contact
X004.6	XS42	18	Undefined		
X004.7	XS42	6	Undefined		
X005.0	XS42	8	The 5 th zero-return signal inspection		Parameter specified
X005.1	XS42	21	Tool-magazine forward in-position	Tool-case vertical inspection	Parameter specified

Add.	Signal interface	Interface pin	Definition		Contactor selection
			Cone tool-magazine	Disc tool-magazine	
X005.2	XS42	9	Tool-magazine backward in-position	Tool-case horizontal inspection	Parameter specified
X005.3	XS42	22	Tool magazine counting switch		Parameter specified
X005.4	XS42	24	Tool-magazine zero-return in-position	Undefined	Parameter specified
X005.5	XS42	12	Current cutter head tool inspection switch	Tool-magazine zero-return in-position	Parameter specified
X005.6	XS42	25	+ limit signal along with the 5 th axis		NC contactor
X005.7	XS42	13	- limit signal along with the 5 th axis		NC contactor
X007.0	XS23	44	Velocity/Position shifting completion		Parameter specified
X007.1	XS23	21	Spindle orientation completion		Parameter specified
X007.2	XS23	5	Spindle velocity arrival		Parameter specified
X007.3	XS23	20	Spindle zero velocity inspection		NC contactor

The definition of each pin for the Hand unit is shown in the following table:

Table 3-2-3-2

Add.	Signal interface	Interface pin	Definition	Contactor selection
X006.0	XS22	5	External MPG axis selection along with the 1 st axis	NORM contactor
X006.1	XS22	23	External MPG axis selection along with the 2 nd axis	NORM contactor
X006.2	XS22	6	External MPG axis selection along with the 3 rd axis	NORM contactor
X006.3	XS22	24	External MPG axis selection along with the 4 th axis	NORM contactor
X006.4	XS22	25	External MPG step length 0.001	NORM contactor
X006.5	XS22	8	External MPG step length 0.01	NORM contactor
X006.6	XS22	26	External MPG step length 0.1	NORM contactor
X006.7	XS22	ESP (9, 22)	External ESP	NC contactor

Add.	Signal interface	Interface pin	Definition	Contactor selection
X008.0	XS22	7	External MPG axis selection along with the 5 th axis	NORM contactor

3.3 Interface Output

3.3.1 Interface Circuit Output

a) The transistor specification for outputting:

- ① When the output is ON, the maximum load current including the instant current is below 200mA.
- ② When the output is ON, the maximum saturation voltage is 1.6V during 200mA, and its typical value is 1V.
- ③ When the output is OFF, the voltage withstand including the instant voltage is below 24+20%.
- ④ When the output is OFF, the leakage current is below 100μA.

b) Loop output:

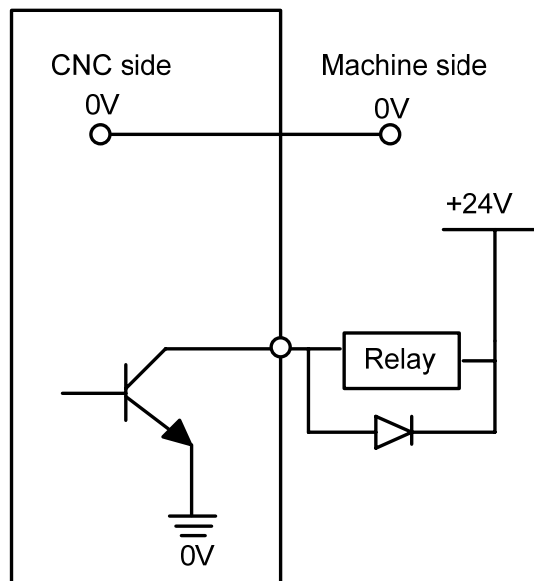

Fig. 3-3-1-1

The output signals of this system are all provided by Darlington transistor, and the corresponding transistors are conducted when the output is enabled.

3.3.2 Interface Definition of Signal Output

Table 3-3-2-1

Add.	Signal interface	Interface pin	Definition	
			Cone tool-magazine	Disc tool-magazine
Y000.0	XS43	1	Z axis brake	
Y000.1	XS43	14	Cooling	
Y000.2	XS43	2	Tool releasing/clamping	
Y000.3	XS43	15	Indefinite	
Y000.4	XS43	17	Spindle brake	
Y000.5	XS43	5	indefinite	
Y000.6	XS43	18	Red alarm indicator	
Y000.7	XS43	6	Yellow indicator	
Y001.0	XS43	8	Green indicator	
Y001.1	XS43	21	Chip-removal control	
Y001.2	XS43	9	Lubrication control	
Y001.3	XS43	22	Machine illumination control	
Y001.4	XS43	24	Hydraulic start	
Y001.5	XS43	12	Spindle blowing	
Y001.6	XS43	25	Index worktable releasing	
Y001.7	XS43	13	Index worktable clamping	
Y002.0	XS44	1	Undefined	
Y002.1	XS44	14	Undefined	
Y002.2	XS44	2	Undefined	
Y002.3	XS44	15	Undefined	
Y002.4	XS44	17	Undefined	
Y002.5	XS44	5	Undefined	Manipulator operation
Y002.6	XS44	18	Chip-punching water valve output	
Y002.7	XS44	6	Undefined	
Y003.0	XS44	8	Tool-magazine positive	
Y003.1	XS44	21	Tool-magazine negative	
Y003.2	XS44	9	Tool-magazine forward	Tool-case vertical
Y003.3	XS44	22	Tool-magazine backward	Tool-case horizontal
Y003.4	XS44	24	The 1 st gear of spindle (Frequency-conversionI/O point control)	
Y003.5	XS44	12	The 2 nd gear of spindle (Frequency-conversionI/O point control)	
Y003.6	XS44	25	The 3 rd gear of spindle (Frequency-conversionI/O point control)	
Y003.7	XS44	13	Undefined	
Y004.0	XS45	1	Undefined	
Y004.1	XS45	14	Undefined	
Y004.2	XS45	2	Undefined	

Add.	Signal interface	Interface pin	Definition	
			Cone tool-magazine	Disc tool-magazine
Y004.3	XS45	15	Undefined	
Y004.4	XS45	17	Undefined	
Y004.5	XS45	5	Undefined	
Y004.6	XS45	18	Undefined	
Y004.7	XS45	6	Undefined	
Y005.0	XS45	8	Undefined	
Y005.1	XS45	21	Undefined	
Y005.2	XS45	9	Undefined	
Y005.3	XS45	22	Undefined	
Y005.4	XS45	24	Undefined	
Y005.5	XS45	12	Undefined	
Y005.6	XS45	25	Undefined	
Y005.7	XS45	13	Undefined	
Y006.0	XS23	9	Spindle positive	
Y006.1	XS23	25	Spindle negative	
Y006.2	XS23	24	Spindle enabling	
Y006.3	XS23	11	Spindle orientation	
Y006.4	XS23	12	Velocity/position shifting	
Y006.5	XS23	27	Zero velocity clamping	

CHAPTER FOUR MACHINE DEBUGGING

This chapter introduces some methods and steps of installing, debugging and trial running of **GSK218MC** system. The machine can be operated correspondingly, after the following debugging steps are completed.

4.1 Debugging Preparation

Debugging **GSK218MC** can be operated as the following steps:

- Connection of the system: The correct connection is the base of the system debugging;
- PLC debugging: Enable the safety (such as the ESP, hard limit, etc) and operation functions.
- Setting the drive unit parameters: Set the parameters of the motor type and the control mode, etc.
- System parameter setting: set the control parameter and velocity parameter, etc.
- Data backup: After the system debugging is completed, the data backup, such as the parameter, compensation data, PLC program, etc. can be performed. It is necessary to notice the following items before debugging and operating the **GSK218MC**.
- Check the polarity of the fly-wheel diode of the relay, electromagnsim valve, etc. for ensuring the overall cables are correctly connected.
- Check the connection phase sequence of heavy current cables of the motor.
- Check the corresponding relationships among the position control cable, the encoder feedback cable and the motor heavy current cable of AC servo feed equipment.
- Confirm the analog voltage code type received by the spindle unit.
- Confirm the overall grounding cables are connected reliably.
- Confirm the availability of the ESP button and its circuit. Ensure the dynamic power of the motion components such as the feed and spindle drive equipments, etc. can be cut off, after the ESP button is controlled or the ESP circuit is cut off.
- Confirm the voltage of each circuit power supply is correct and the polar is connected right.
- Confirm the power supply specification in each circuit is correct.
- Confirm each transformer specification and its in/out direction in the circuit are correct.
- Confirm the power supply leading in/out direction of each breaker is correct.

4.2 System Power-ON

- Press the ESP button and make sure that the overall air switches are OFF.
- Switch on the main power air switch of the electric cabinet.
- Switch on the fuse or the air switch controlled by DC 24V; and check whether the DC24V power is normal.
- Check whether the reset of powers are normal.
- Turn on the GSK218MC CNC equipment

4.3 ESP and Limit

This system owns the software limit function, on the safe side, it is recommended to use the hardware limit measurement simultaneously, and install the +/-limit switch along with each axis.

About GSK218MC and 218MC-U1 systems, user can monitor and check the state of the ESP input signal through checking the NO: 1#4 (ESP) on [X signal] software interface of the <Diagnosis>. The overall air switches in the system should be cut off after the ESP button is controlled. Check the NO: 23#5 (MT-ESP) for GSK218MC-H and GSK218MC-V.

Verify the availability of the overtravel limit switch along with each axis, the correction of the alarm display and the effectiveness of the overtravel releasing button by slowly moving each coordinate axis in the Manual or MPG mode; the system alarm may occur when the overtravel issues or the ESP button is controlled; the system alarm may be released by the overtravel releasing button reversely.

- ESP signal

GSK218MC and 218MC-U1 parameter diagnosis (The input state on the system side)

State add.				X1.4				
Pin No.				XS40.24				

GSK218MC-H and GSK218MC-V parameter diagnosis (The input state on the system side)

State add.			X23.5					
Pin No.								

Note: If the system occurs: 0251: ESP alarm, check whether the state of the X1.4 of 218MC-U1 system is set to 1; check the X23.5 of the 218MC-H/-V system. 218MC system ESP switch sets as the external one, and 218MC-H/-V system ESP switch sets as the internal one, which is configured on the system's operation panel.

In order to correctly display the alarm of "some axis (the 1st, the 2nd or the 3rd axis) along with the

movement direction when the servo axis overtravel occurs. Simultaneously, preventing the overtravel alarm of some axis occurs, one axis can not be moved toward to the overtravel if the overtravel is free. GSK218MC series system provides two connection methods of the stroke limit switch for the customers' requirements.

A. There are two situations for the stroke limit switch:

(+ limit of one axis uses one stroke switch, - direction uses another one)

1. It is necessary to strictly connect it based upon the following table:

Table 4-3-1

Add.	Signal interface	Interface pin No.	Definition	Contact selection
X000.0	XS40	1	+ stroke limit signal along with the 1 st axis	NC contactor
X000.1	XS40	14	- stroke limit signal along with the 1 st axis	NC contactor
X000.2	XS40	2	+ stroke limit signal along with the 2 nd axis	NC contactor
X000.3	XS40	15	- stroke limit signal along with the 2 nd axis	NC contactor
X000.4	XS40	17	+ stroke limit signal along with the 3 rd axis	NC contactor
X000.5	XS40	5	- stroke limit signal along with the 3 rd axis	NC contactor
X000.6	XS40	18	+ stroke limit signal along with the 4 th axis	NC contactor
X000.7	XS40	6	- stroke limit signal along with the 4 th axis	NC contactor
X005.6	XS42	25	+ stroke limit signal along with the 5 th axis	NC contactor
X005.7	XS42	13	- stroke limit signal along with the 5 th axis	NC contactor

2. Alter the following parameter:

Table 4-3-2

Add.	Definition	State 0	State 1	Setting value
K006.0	Whether uses one limit switch	2pcs	1pc	0

B. When one stroke limit switch occurs:

(It means that the + and - limit of one axis are shared with one stroke switch)

1. It is necessary to strictly connect it based upon the following table:

Table 4-3-3

Add.	Signal interface	Interface pin No.	Definition	Contact selection
X000.0	XS40	1	Stroke limit signal along with the 1 st axis	NC contactor
X000.2	XS40	2	Stroke limit signal along with the 2 nd axis	NC contactor
X000.4	XS40	17	Stroke limit signal along with the 3 rd axis	NC contactor

X000.6	XS40	18	Stroke limit signal along with the 4 th axis	NC contactor
--------	------	----	---	--------------

2. Alter the following parameter

Table 4-3-4

Add.	Definition	State 0	State 1	Setting value
K006.0	Whether uses one limit switch	2pcs	1pc	1

State parameter

0	1	1	BFA	LZR						
---	---	---	-----	-----	--	--	--	--	--	--

LZR =1: Perform the stroke inspection after the power is turned on till to the manual reference position return.

=0: Do not perform the stroke inspection after the power is turned on till to the manual reference position return.

BFA =1: Alarm occurs after the overtravel when the overtravel command issues.

=0: Alarm occurs before the overtravel when the overtravel command issues.

System parameter No.

0	3	1			G13					
---	---	---	--	--	-----	--	--	--	--	--

G13 =1: It is set as G13 mode when switches on the power or cleans the state.

=0: It is set as G12 mode when switches on the power or cleans the state.

System parameter No.

0	6	1		LALM						
---	---	---	--	------	--	--	--	--	--	--

LALM =1: Regardless of the hard limit alarm

=0: Regard the hard limit alarm.

4.4 Gear Ratio Adjustment

When the distance between the machine movement and the shifting one of displayed in the system coordinate are inconsistent, the adjustment of the electric gear ratio can be altered by the system parameter **P160~ P164** and **P165~ P169** for adapting different mechanical drive ratio.

Set the frequency-conversion of the position code pulse (Electric gear)

It is very convenient to match each pulse source by setting the parameter for the user's ideal control resolution (Angle/pulse) in the position control mode

Calculation formula:

$$G = \frac{\text{Frequency-conversion numerator}}{\text{Frequency-conversion denominator}} = \frac{4C}{L/\zeta} \times \frac{Z_M}{Z_D}$$

G: Electric gear ratio;

L: Screw leading;

ζ: The least output code unit of the system (mm/pulse)

C: Photoelectric encoder resolution/revolution

Z_M : Screw terminal gear number } With variable gear
 Z_D : Motor terminal gear number }

System side:

Frequency-division nominator: System parameter No.160, No.161, No.162, No.163 and No.164 (Code frequency-multiplication coefficient)

Frequency-division: No.165, No.166, No.167, No.168 and No.169 (code frequency-division coefficient)

Digit servo side:

Frequency-division nominator: PA12 (Code frequency-multiplication coefficient)

Frequency-division denominator: PA13 (Code frequency-division coefficient)

[Example 1] If the screw leading is 8mm, the least output code unit of the system is 0.001mm, the resolution of the motor encoder is 2500, so:

$$G = \frac{4C}{L/\zeta} \times \frac{Z_M}{Z_D} = \frac{4 \times 2500}{8/0.001} \times \frac{1}{1} = \frac{5}{4}$$

Then, the data parameters No. 160 (CMRX) =5, No.165 (CMDX) =4;

The parameter setting of the system gear ratio is same as that of the digit servo gear ratio. If it is equipped with the digit servo with the electrical gear ratio function, the electrical gear ratio of the system is set as 1:1, and the calculated electrical gear ratio is set into the digit servo.

If the step drive is required, try to select the drive unit with the step subdivision function, select the mechanical transmission ratio properly, and try to set the system electrical gear ratio as 1:1, so the big difference between the numerator and the denominator of the electrical gear ratio can be avoided.

[Example 2] The formula of the gear ratio of the rotation axis:

$$G = \frac{N \times C \times 4}{P} = \frac{1 \times 2500 \times 4}{360 \times 1000 \times \text{deceleration ratio (drive/driven gear)}}$$

Note: Motor's photoelectric encoder resolution C=2500.

4.5 Backlash Compensation

The machining accuracy can be enhanced using the dial gauge, micrometer gauge or laser inspection measure, and backlash compensation with precision compensation; and therefore, it is not recommended that the screw backlash can not be measured by MPG or single step method. It is better to measure the backlash based upon the following method:

- Program editing:

```
O0001;
N10 G01 G91 X1 F800 ;
N20 X1 ;
N30 X1 ;
N40 X-1 ;
N50 M30 ;
```

- The backlash error compensation value is set as 0 before measuring;
- Single operation program, find a measure reference A after positioning twice, the record the current data; operation for 1mm along with the same direction, then operation 1mm to point B reversely, and lastly read the current data.

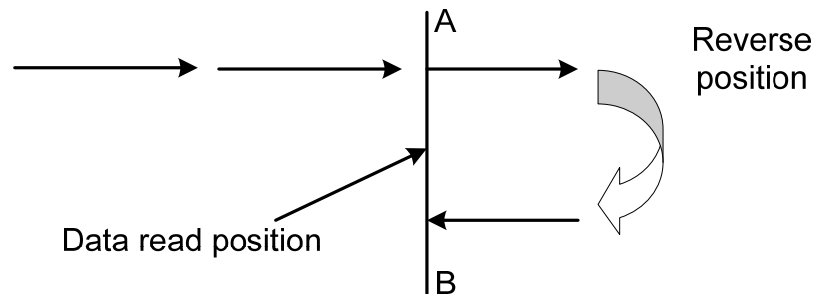

Fig. 4-5-1 Measuring method of the backlash

- The backlash error compensation value = | The data recorded by point A - the data recorded by point B |; The calculated data are input into the corresponding system parameters.

Data A: The data of dial gauge in Point A;

Data B: The data of dial gauge in Point B;

Pulse equivalent: 1 μm

Note 1: Data parameter P190~P194 set the backlash compensation value of each axis

Note 2: The backlash method and compensation frequency can be set by data parameter P195~P199.

Note 3: In order to guarantee the machine accuracy, inspect the backlash again after using the machine for 3 months.

System parameter number

0	1	8	RVCS							RVIT
---	---	---	------	--	--	--	--	--	--	------

- RVIT** =1: The next block is performed after the compensation is completed when the backlash is more than the interval allowance D-value.
 =0: The next block is performed before the compensation is completed when the backlash is more than the interval allowance D-value.
- RVCS** =1: Backlash compensation method: up/down velocity
 =0: Backlash compensation method: fixed frequency.

4.6 Setting Related with Drive unit

If the machine movement direction is inconsistent with the shifting code requirement, which can be altered the position parameter No: 3#1~ NO: 3#5.

System parameter number

0	0	3				DIR5	DIR4	DIR3	DIR2	DIR1
---	---	---	--	--	--	------	------	------	------	------

- DIR1** =1: - feed direction along with the 1st axis
 =0: + feed direction along with the 1st axis
- DIR2** =1: - feed direction along with the 2nd axis
 =0: + feed direction along with the 2nd axis
- DIR3** =1: - feed direction along with the 3rd axis
 =0: + feed direction along with the 3rd axis
- DIR4** =1: - feed direction along with the 4th axis
 =0: + feed direction along with the 4th axis
- DIR5** =1: - feed direction along with the 5th axis
 =0: = feed direction along with the 5th axis

Firstly, check whether the drive unit alarms, the connection of the drive unit is correct if the system displays the 1st, 2nd, 3rd, 4th, 5th or the spindle drive unit alarm when the power is turned on. If does not, the Level set by the system’s alarm parameter is unmatched with the one of the drive unit, which can be set the bit parameter **No.: 19#0 ~ No: 19#4** for whether the High Level is enabled or the Low Level one. As well, the bit parameters **No.: 19#0 ~ No: 19#4** are set as 0 when matching with the drive unit manufactured by GSK. Eliminate the system alarm by <RESETTING> after the parameters are altered. Simultaneously, on the safe side, it is better to set the parameter switch of the system as “OFF” state.

Do not connect this signal if the used drive unit does not provide a drive alarm signal;

simultaneously, the state parameter **No: 19#0 ~ No: 19#4** are set to 1. It is necessary to further judge the malfunction is on the side of the system or the drive unit when the system displays the drive unit alarm.

System parameter number

0	1	9			ALMS	ALM5	ALM4	ALM3	ALM2	ALM1
---	---	---	--	--	------	------	------	------	------	------

- ALM1** =1: It alarms when the 1st axis drive alarm signal is set to 1.
=0: It alarms when the 1st axis drive alarm signal is set to 0.
- ALM2** =1: It alarms when the 2nd axis drive alarm signal is set to 1.
=0: It alarms when the 2nd axis drive alarm signal is set to 0.
- ALM3** =1: It alarms when the 3rd axis drive alarm signal is set to 1.
=0: It alarms when the 3rd axis drive alarm signal is set to 0.
- ALM4** =1: It alarms when the 4th axis drive alarm signal is set to 1.
=0: It alarms when the 4th axis drive alarm signal is set to 0.
- ALM5** =1: It alarms when the 5th axis drive alarm signal is set to 1.
=0: It alarms when the 5th axis drive alarm signal is set to 0.
- ALMS** =1: It alarms when the spindle drive alarm signal is set to 1.
=0: It alarms when the spindle drive alarm signal is set to 0.

System parameter number

0	6	1	FALM			SALM				
---	---	---	------	--	--	------	--	--	--	--

- SALM** =1: Regardless of the spindle drive unit alarm.
=0: Regard for the spindle drive unit alarm.
- FALM** =1: Regardless of the feed axis drive unit alarm.
=0: Regard for the feed axis drive unit alarm.

4.7 Machine Tool Pitch Compensation

- **The precautions set by the pitch error compensation**

1. The set compensation amount is related with the position relationships between the zero and compensation point, the mechanical movement direction and compensation interval, etc.
2. The compensation amount of the compensation point N (N=0, 1, 2, 3,255) is determined by mechanical error of the area N, N-1. The compensation point number along with each axis can be set to 256.
3. The mechanical zero is regarded as the compensation origin, and the compensation data set by each axis is set as the parameter value.

4. The axes can be compensated: X, Y, Z and 4th
5. The range of the compensation amount: compensation value (-999 pulse equivalent~ +999 pulse equivalent) x the least compensation unit. (Metric system: 0.001mm; Inch system: 0.0001 inch; angle: 0.001deg).
6. The unit of the pitch error compensation of the rotation axis is deg.
7. The system ignores the compensation when pitch error compensation interval is set to 0. (The pitch error compensation is performed near the middle point of the compensation area)
8. After the related parameter of the pitch error compensation is set, and it can be enabled when its power restarts and the machinery zero performs.
9. The machinery zero of the tool can not be altered freely after the pitch compensation is performed, that is, the position of the pitch compensation may inconsistent with the one of the machine's actual compensation, and therefore, the machine accuracy is then decreased. If it is necessary to set the machinery zero again for some special reasons, the data of pitch error compensation should be inspected again accordingly.
10. The pitch error compensation data can be set for compensating the pitch error along with each axis, and therefore, enhance the machine accuracy, and its unit of the compensation value is the inspection unit. The pitch error is varied from one machine to another, so did the compensation data. In principle, the final user can not alter these data after the pitch error compensation data are set; and therefore, the machine accuracy may reduce by changing these data.

- **The relative parameters set by the pitch error compensation**

1. Whether to perform the pitch compensation is set by bit parameter **NO:37#0; (0: Do not compensate, 1: Compensation)**
2. Set the pitch error compensation interval of each axis by data parameter **P226~230;**
3. The pitch compensation number of the reference point along with each axis is set by data parameter **P216~220;**

The setting explanations of the pitch compensation number of the reference position along with each axis are shown below:

- ① The dimension of the pitch compensation number for each compensation point is corresponding to the one of the coordinate value by this point; that is, the bigger the compensation point of the machine coordinate value is, the bigger the corresponding compensation number is.
- ② When the pitch error compensation is set as required in one area, usually, the compensation number of its least compensation point which locates on the coordinate system of this area is regarded as 0. The pitch compensation number of reference point is determined by the position relationships between the reference point and the No.0 compensation point.

③ **For example:** It is supposed that the travel of the machine is 100mm, the compensation interval of the pitch error is 10mm, and the compensation number is from No.0 to No.10. And then, the pitch compensation number of the reference point is decided as follows:

A. The zero direction of the machine is the positive one. The least value of the machine coordinate system in this area is -100, then the compensation number on the -100 point treats as 0; and therefore, the compensation number of the reference point can be calculated as No.10 based upon the position relationships between the reference point and No.0 compensation point; refer to the Fig. 4-7-1:

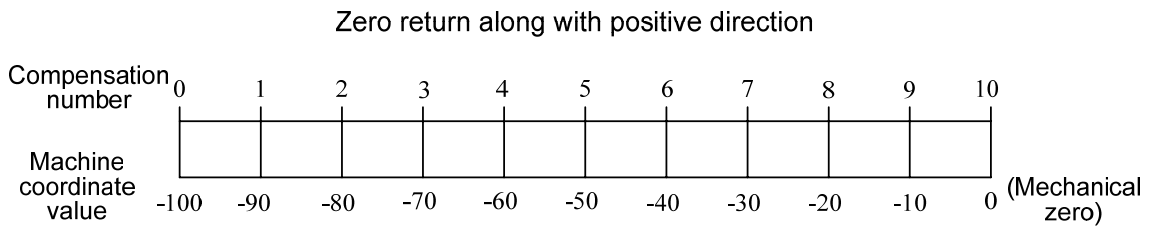

Fig. 4-7-1

B. The zero return direction is the negative one. The least value of the coordinate system in this area is 0, which can be calculated out the compensation number 0 of the reference position; refer to the Fig. 4-7-2:

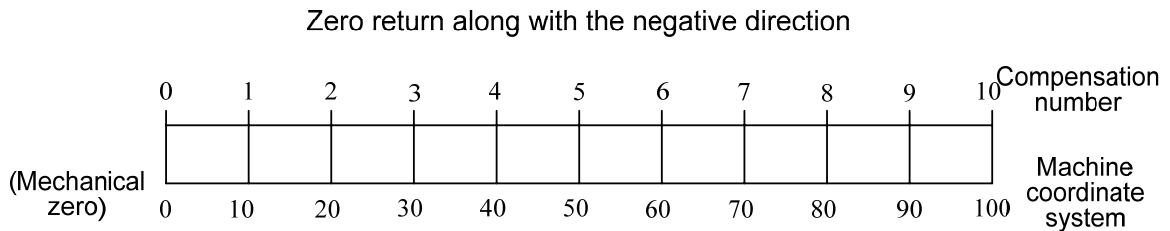

Fig. 4-7-2

C. The reference point locates on the middle of the machine, usually, it generates when using the absolute encoder. The least value of the coordinate system in this area is -50, then the compensation number of the -50 is 0; and therefore, the compensation number of the reference point is No.5 based upon the position relationships between the reference point and No.0 compensation point; refer to the Fig. 4-7-3:

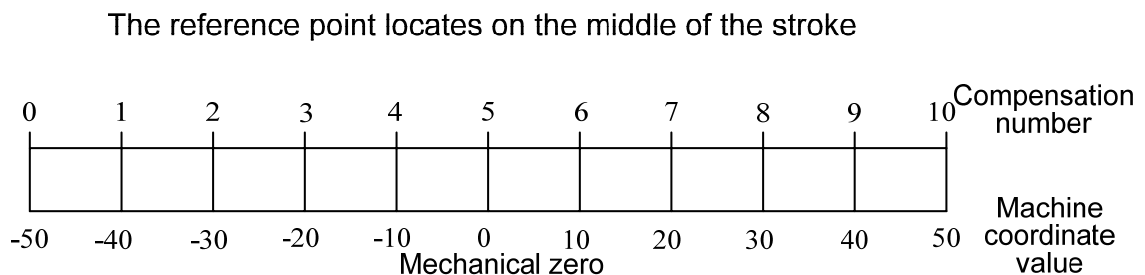

Fig. 4-7-3

Note: The relative parameter of each pitch error compensation should be strictly set based upon the actual situation when inspecting the pitch error; the machine accuracy may reduce if the setting error occurs.

- **The corresponding relationship between the pitch error compensation amount and the reference point compensation series number**

The corresponding relationship between the pitch error compensation amount and the compensation number is shown in the Fig. 4-7-4:

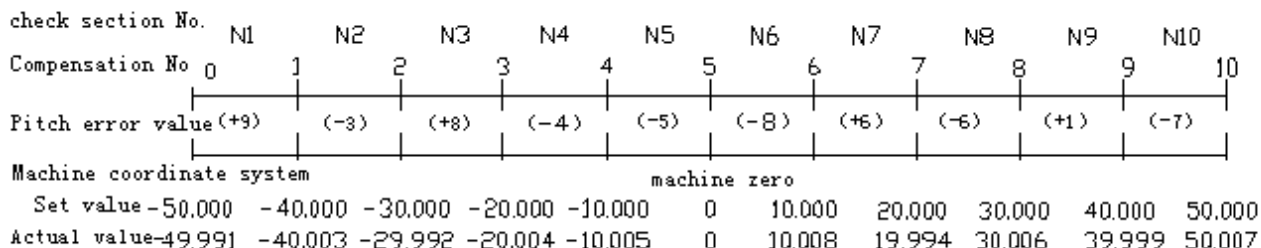

Fig. 4-7-4

The corresponding relationship between the pitch error compensation amount and the compensation number is shown in the Table. 4-7-1:

Table 4-7-1

Compensation number	0	1	2	3	4	5	6	7	8	9	10
Compensation amount	0	+9	-3	+8	-4	-5	-8	+6	-6	+1	-7

The error inspection can be performed after the distance between the least value and the most value of the machine worktable movement stroke is divided into N sections; the pitch error of each interval is fixed, regardless of the control of the worktable movement direction. For example, Fig. 4-7-4 shows that the error value in the N1 area should be input to the corresponding compensation series number “1” for the system, in this case, the system then can be correctly called the pitch error compensation value in the N1 area. The error value of N6 area in the Fig. 4-7-4 inputs to the corresponding position of compensation series number “6”, in this way, the system can be correctly called the pitch error compensation value in the N6 area. Therefore, its relationships that the pitch error value in each area is corresponding to the end position of its area along with positive movement.

- **The example set by the pitch error compensation**

The example of the linear axis pitch error compensation, X axis is regarded as an example, the setting method of other axes are identical.

A. Zero return along with positive direction, the error compensation is performed the inspection based upon that the mechanical zero regards as reference point.

It is supposed that the actual situation is: the pitch error compensation interval is 10mm, the stroke along with X axis is 100mm, and then the point number of compensation is 11, the compensation number of the reference point is 10, the relative data parameter setting is shown in the table 4-7-2:

Table 4-7-2

Parameter	Default setting value	Actual setting value
P216: The reference point compensation number along with the 1 st axis	0	10
P226: The pitch error compensation interval along with the 1 st axis	5	10

The actual measure value is as the Fig. 4-7-5:

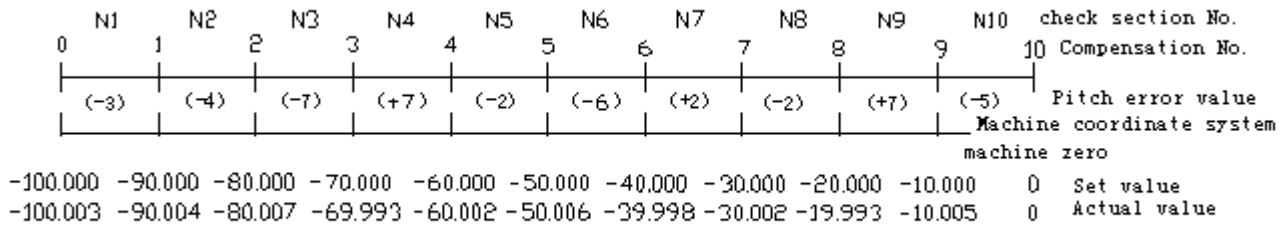

Fig. 4-7-5

In this case, the pitch error compensation value along with X axis in the system is shown in the table 4-7-3:

Table 4-7-3

Compensation number	0	1	2	3	4	5	6	7	8	9	10
Compensation value	0	-3	-4	-7	+7	-2	-6	+2	-2	+7	-5

B. Zero return along with the negative direction, the error compensation is performed the inspection based upon that the mechanical zero treats as reference point.

It is supposed that the actual situation is: the interval of the pitch error compensation is 10mm, the stroke along with X axis is 100mm, and the relative data parameter setting is shown in the Table 4-7-4:

Table 4-7-4

Parameter	Default setting value	Actual setting value
P216: the reference point compensation number along with the 1 st axis	0	0
P226: the pitch error compensation interval along with the 1 st axis	5	10

The actual measure value is shown in the Fig. 4-7-6:

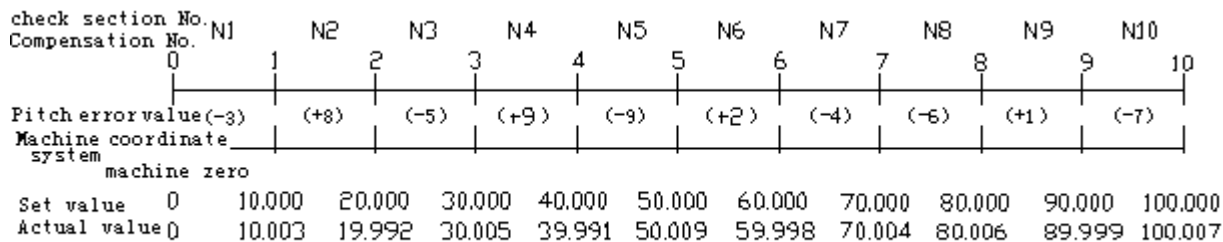

Fig. 4-7-6

In this case, the pitch error compensation value along with X axis in the system is set as the Table 4-7-5:

Table 4-7-5

Compensation number	0	1	2	3	4	5	6	7	8	9	10
Compensation value	0	-3	+8	-5	+9	-9	+2	-4	-6	+1	-7

C. The mechanical zero locates on the middle of the stroke, the error compensation performs inspection based upon that the mechanical zero treats as reference point.

It is supposed that the actual situation is: the pitch error compensation interval is 10mm, the positive limit value along with the negative is -50~+50, the relative data parameter setting is shown in the table 4-7-6:

Table 4-7-6

Parameter	Default setting	Actual setting
P216: The compensation number of the reference point along with the 1 st axis	0	5
P226: The pitch error compensation interval along with the 1 st axis	5	10

The actual measure value is shown as Fig.4-7-7:

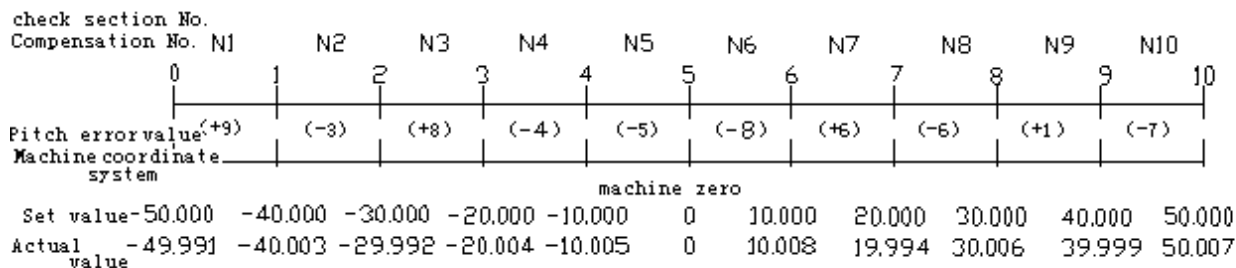

Fig. 4-7-7

In this case, the pitch error compensation value along with X axis in the system is set as the Table 4-7-7:

Table 4-7-7

Compensation number	0	1	2	3	4	5	6	7	8	9	10
Compensation value	0	+9	-3	+8	-4	+5	-8	+6	-6	+1	-7

Rotation axis pitch error example, the character of the rotation axis is overlapped of its start and end position, and its shifting value of each revolution is 360 degree, which is divided into N areas; refer to the Fig. 4-7-8:

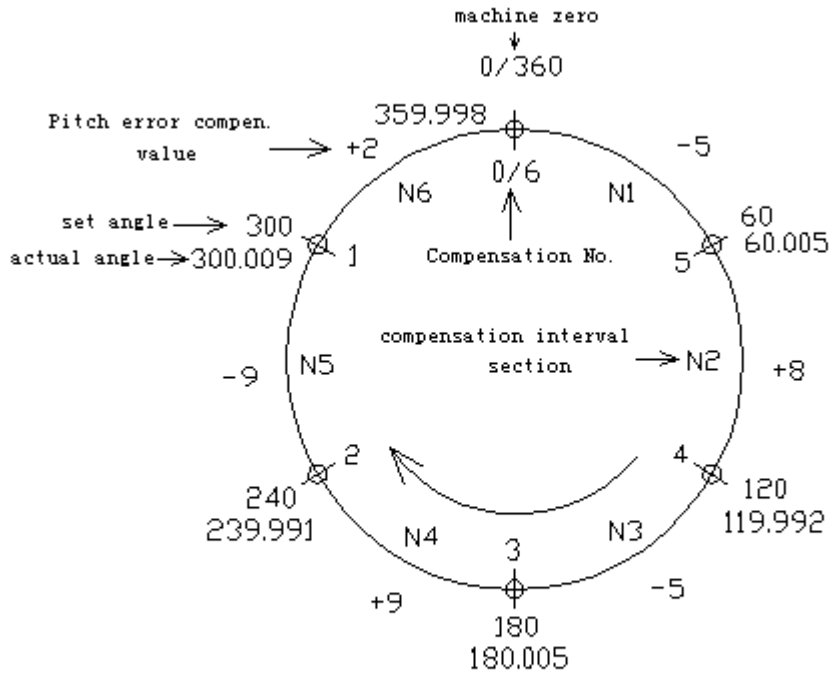

Fig. 4-7-8

The following figure (Fig. 4-7-9) shows after the Fig. 4-7-8 unfolded:

check section No.	N6	N1	N2	N3	N4	N5	N6	N1	N2	
Compensation No.	5	0/6	1	2	3	4	5	0/6	1	2
Pitch error value	(+2)	(-5)	(+8)	(-5)	(+9)	(-9)	(+2)	(-5)	(+8)	
Machine coordinate system	machine zero					machine zero				
Set value	300.000	0/360.000	60.000	120.000	180.000	240.000	300.000	0/360.000	60.000	120.000
Actual value	300.009	359.998	60.005	119.992	180.005	239.991	300.009	359.998	60.005	119.992

Fig. 4-7-9

In this case, the compensation amount of both the compensation start and end are shared with same area, and therefore, the start and end of the compensation value are set to same. The shifting value of each revolution is 360 degree based upon the character of the revolving axis; the compensation amount of the overall compensation areas are 0 (that is, $N1+N2+\dots+N6=0$), if they are not 0, the pitch error of each rotation will be accumulated, so that the position offset occurs. The more along with the equidirectional rotation is, the bigger of the position offset value is. Refer to the Fig. 4-7-9 for the pitch error compensation. In this moment, the parameter setting of the pitch error data in the system is shown in the Table 4-7-8:

Table 4-7-8

Parameter	Default setting	Actual setting
P219: The compensation number of the reference position along with the 4 th axis	0	0
P226: The pitch error compensation interval along with the 4 th axis.	5	60

In this case, the pitch error compensation value of the rotation axis (An axis) in the system is set as Fig. 4-7-9:

Table 4-7-9

Compensation number	0	1	2	3	4	5	6
Compensation value	+2	-5	+8	-5	+9	-9	+2

4.8 Mechanical Zero Return (Machine Zero Return)

The concept of mechanical zero point(machine zero point)

The machine coordinate system is the fixed one on the machine. And the origin of the machine coordinate system is called the mechanical zero point (or the machine zero point). It is also called as the reference point in this manual, which is the specified mechanical origin by machine manufacture. Usually, it installs at the Max. stroke along with positive of the X, Y, Z, the 4th and the 5th. We don't know the mechanical zero when the CNC equipment is turned on, generally, the Auto or Manual mechanical zero should be performed here.

The zero return mode is divided into two kinds: 1. After the block; 2. Before the block. They are set by parameter **No: 6#1**.

There are two zero return methods: 1. With one-turn signal; 2. Without one-turn signal. They are determined by parameter **NO: 6#6**.

When the zero return motor is without one-turn signal, the zero return method also can be divided into type A and B, which are set by parameter **NO: 6#7**.

4.8.1 Mechanical Zero Return in Pulse Method

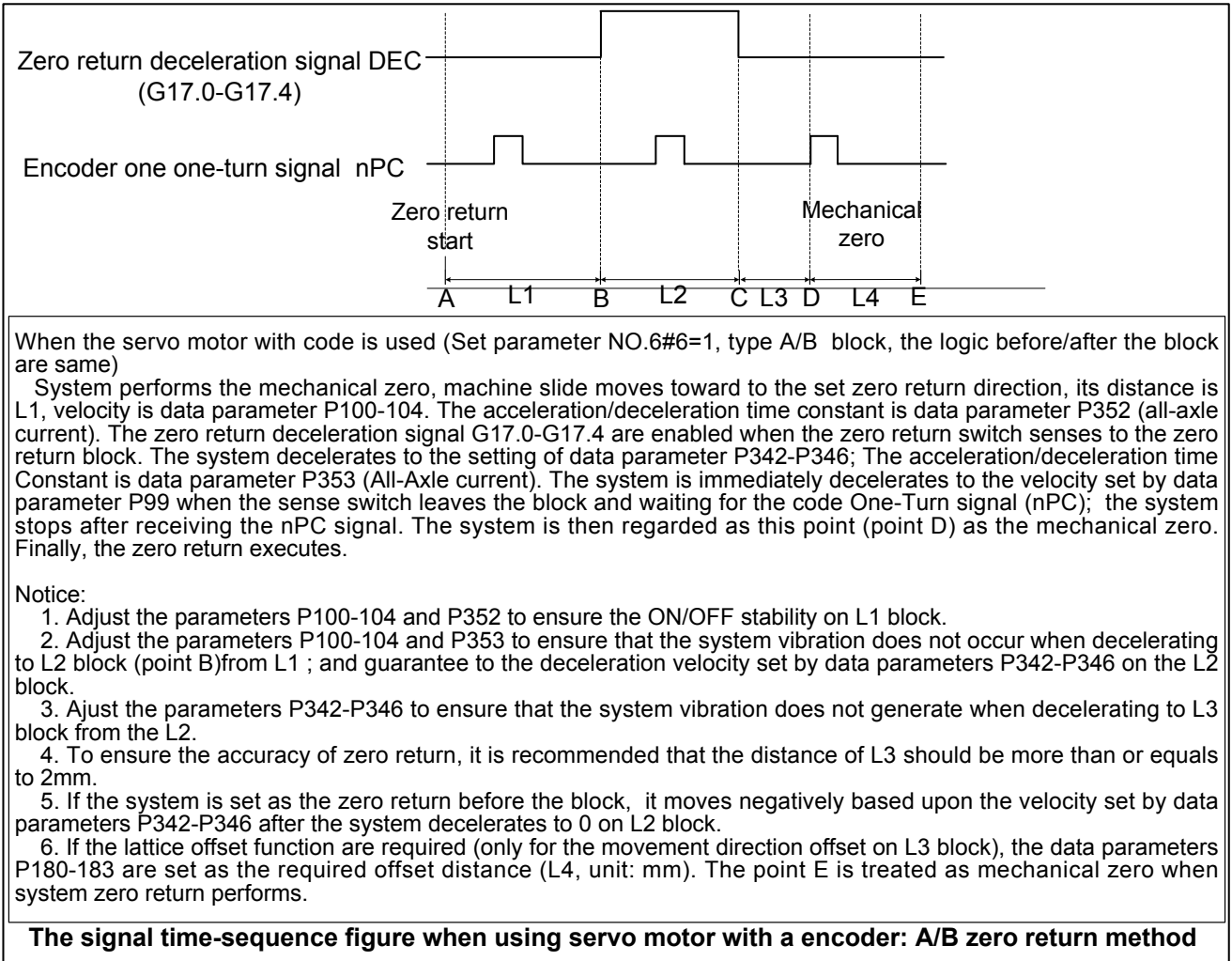

Fig. 4-8-1-1

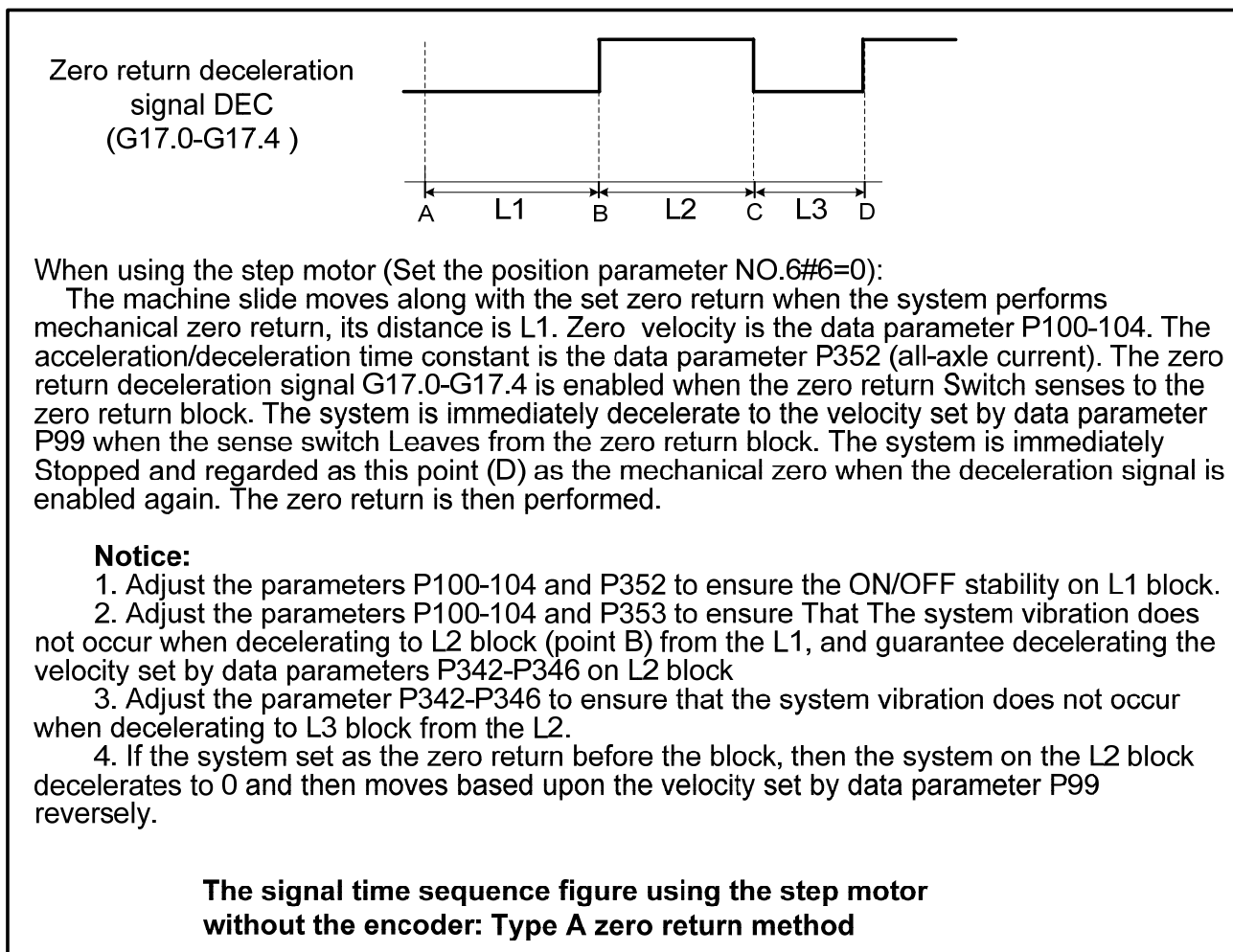
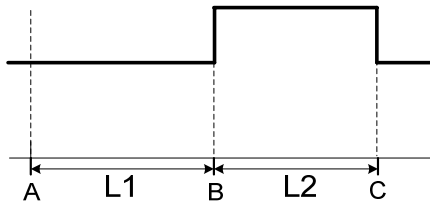

Fig. 4-8-1-2

Zero return deceleration signal DEC
(G17.0-G17.4)



When the step motor is used (Set position parameter NO.6#6=0):

The machine tool Slide moves toward the set zero direction when the system performs mechanical zero return, its distance is L1. The velocity is data parameter P100-104. The acceleration/deceleration time constant is the data parameter P352 (All axle current). The zero return deceleration signal G17.0-G17.4 is enabled when the zero return switch senses its block. The system decelerates to the velocity set by data parameter P342-P346. The acceleration time Constant is Data Parameter P353 (all axle current). The system is immediately stopped and regarded this point (C) as mechanical zero. Finally, the zero return is executed.

Notice:

1. Adjust the parameters P100-104 and P352 to ensure the ON/OFF stability on L1 block.
2. Adjust the parameters P100-104 and P353 to ensure that the system vibration does not occur when L1 decelerates to L2 block (point B). Guarantee decelerating to the velocity set by data parameters P342-P346 on L2 block.
3. Adjust the parameters P342-P346 to ensure that the system vibration does not occur when the L2 block decelerates to the L3 (point C).
4. It is suggested that the parameters P342-P346 are set to small as much as possible for guarantee the zero return accuracy, its recommended value is 40.
5. If the system set the zero return before the block, then the system decelerates to 0 and moves based upon the velocity set by data parameters P342-P346 reversely.

Signal time sequence figure using the step motor without encoder: Type B zero return method

Fig. 4-8-1-3

1. The operation steps of the pulse servo mechanical zero return



- (1) Enter the mechanical zero return operation method by , in this case, the “Mechanical zero” displays at the lower right corner on the LCD.
- (2) Select the X, Y, Z, 4th or 5th axis to be returned to the mechanical zero, and the zero return direction is determined by bit parameter **NO:7#0~NO:7#4**.
- (3) The machine moves along with the mechanical zero rapidly (The movement velocity is determined by parameters **P100~P104**) before the deceleration point. The data parameters **P342~P346** set the zero return velocity along with each axis after meeting the declaration switch, and then moves to mechanical zero (that is reference position) based upon the FL (It is set by data parameter P099) velocity after separating from the block. The coordinate axis stops movement after returning to the mechanical zero, the zero return indicator is then lighted up.

For example:

The common increment zero return along with the 1st axis is regarded as an example. Impact the

block with the higher velocity F4000 (data parameter P100 set as 4000) at the beginning of the 1st axis, pass through the block based upon the F500 (data parameter P342 set to 500) after touching the deceleration switch, and then check the one-turn pulse z signal of the servo based upon the very slow velocity F40 (data parameter P99 is set to 40), and lastly, it will immediately stop after capture; refer to the Fig. 4-8-1-4.

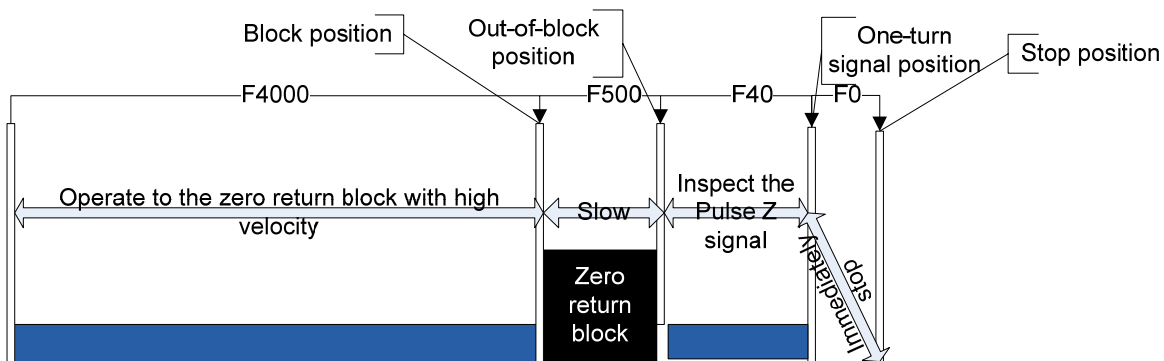

Fig. 4-8-1-4

2. The operation step using the program code mechanical zero return

The program code G28 zero return can be performed after the bit parameter **NO: 6#3** is set to 0, that is the reason, the inspection stroke block is shared the same efficiency with the manual mechanical zero return.

4.8.2 Servo Zero Return Function Setting of Bus Type

There are three zero return methods when system allocates with the bus servo, which is separately composed of common zero return, high velocity zero return and multi-coil absolute setting zero. These setting methods are separately introduced as follows:

I. Common zero return

Set the bit parameter **No: 0#0=1, No: 5#4=0**, system can select one-turn signal or non one-turn based upon the common zero return method of which this zero return method can used in the increment method version of the system configuration Da98B, GE2000. The zero return along with each axis is enabled in the zero return method.

The concrete operation steps are basic consistency with the pulse servo zero turn; refer to *the operation steps of pulse mechanical zero return in section 4.8.1.*

II. High velocity increment zero return

Set the bit parameter **No: 0#0=1, No: 5#4=1**, the system performs the zero return based upon the high velocity method, only the one-turn signal can be selected which can be used in the increment version of the system configuration GE2000.

Configure the bit parameter **No: 20#7=0, No: 20#6=1** and **No: 20#5=0** into GE2000 series

single-core absolute, multi-core absolute version. And set that the parameters **P347~P351** can be modified the single-core zero signal position of the absolute encoder. The zero return along with each axis is enabled in the zero return method.

Zero return step:



1. Enter mechanical zero operation method by  button, in this case, the “Mechanical zero” displays at the lower right corner on the LCD.
2. Select the X, Y, Z, 4th or 5th axis to be returned to the mechanical zero, and the zero return direction is determined by bit parameter **N0:7#0~N0:7#4**.
3. The machine moves along with the mechanical zero rapidly (The movement velocity is determined by parameters **P100~P104**) before the deceleration point. The data parameters **P342~P346** set the zero return velocity along with each axis after meeting the deceleration switch, and then inquires the pulse Z one-turn signal position continually based upon the velocity set by the data parameter **P342~P346**, after releasing from the block; it decelerates to stop after inspecting, and then return to the mechanical point (that is reference position) based upon the velocity set by data parameter **P354**. The coordinate axis stops movement after returning to the mechanical zero, the zero return indicator is then lighted up.

For example:

The common increment zero of the 1st axis is regarded as the example, the 1st axis begins to impact the block based upon the higher velocity F4000 (Data parameter **P100** sets to 4000); F500 (Data parameter **P342** sets to 500) passes through the block after touching the deceleration switch; search the one-turn Z pulse signal of the servo based upon the very slow velocity F40 (Data parameter **P99** sets to 40) after releasing from the block; it immediately stops after capturing; refer to the Fig. 4-8-1-4.

The common increment zero return along with the 1st axis is regarded as an example. Impact the block with the higher velocity F4000 (Data parameter **P100** sets as 4000) at the beginning of the 1st axis, pass through the block based upon the F500 (Data parameter **P342** sets to 500) after touching the deceleration switch, and then check the one-turn pulse z signal position based upon the F5000 velocity after releasing from the block; it decelerates to stop after inspecting, and then return to the mechanical zero based upon the F200 velocity (Data parameter **P354** sets to 200); refer to the Fig. 4-8-2-1:

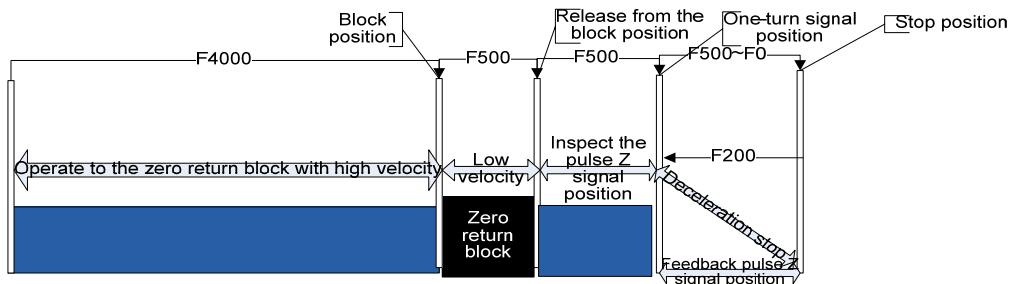

Fig. 4-8-2-1

III. Multi-core absolute zero setting

Set the bit parameter **No: 0#0=1**, **No: 20#7=1**, **No: 20#6=1**, **No: 20#5=1** into GE2000 series single-core absolute, multi-core absolute version. Move each axis to the considered machine zero position, and then set the 1st axis zero position of the bit parameter **No: 21#0=1** in the MDI mode, set the 2nd axis zero position of the **No: 21#1=1**, the 3rd axis of the **No: 21#2=1**, the 4th axis of the **No: 21#3=1**, and the 5th axis of **No: 21#4=1**. The zero return indicator of each axis lights up, the machine zero is then set successfully.

Zero return steps:



Enter the system page by , shift the sub-interface [Bus Configuration] display by corresponding software. Refer to the following figure for details (Fig. 4-8-2-2):

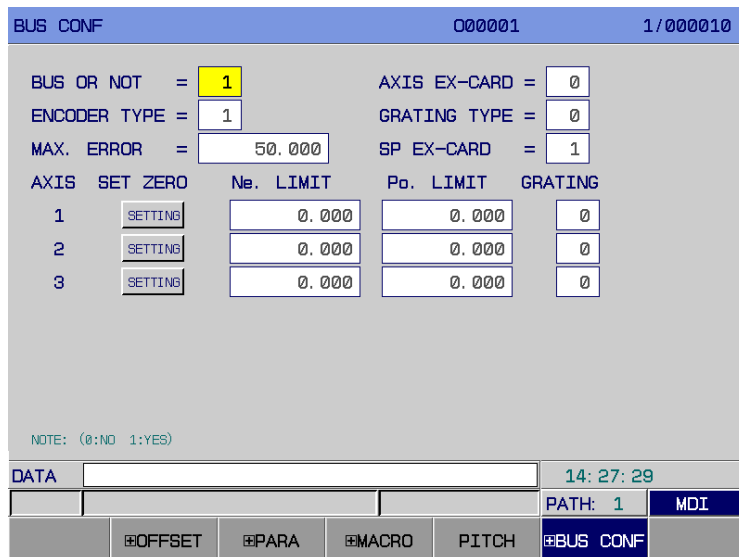



Fig. 4-8-2-2

Multi-core absolute zero setting:

- a) Firstly, set the gear ratio, feed axis direction and zero return direction of the system terminal, and the turn on the power again after power-off.

b) In MDI mode, the “Whether it is bus” on the bus configuration interface is set to 1, “Encoder type” set to 1, and set the machine zero position based upon each axis manually.

c) Move the cursor to the  , the zero return indicator lights on by pressing the <Input> twice, and the current position record of the motor’s absolute encoder along with each axis is regarded as machine zero. Still, the zero indicator lights on after the system is turn on again. Manually set the negative boundary and positive one based upon the actual Max. stroke of the machine, so that the current machine absolute coordinate offsets forward or backward a value; lastly, the bit parameter **No.61#6** is set to 1, the positive or negative limit is then enabled.

Setting range: -99999.9999~99999.9999, also, the positive/negative boundary of each axis can be directly set by parameters **P450~P459**.

d) Whether configure the grating or not. Set whether separately configure the grating along with each axis, 0: Without configured grating, 1: With configured grating. Also, it can be separately set by bit parameters **No: 1#3~1#7**.

INPUT

e) Confirm it by pressing the .

Note 1: After the machine zero is set, if the system that is altered the zero return direction along with each axis, the feed axis direction, the servo and system gear ratio will cause zero missing; and it is necessary to set the machine zero again.

Note 2: After the machine zero is set again, it will be affected other reference point, for example, the 2nd and the 3rd reference point should be set again.

For example:

The absolute encoder zero setting can be set the zero position based upon the absolute position of the motor’s feedback. Set the bit parameters #20.7=1, #20.6=1 and #20.5=1; refer to the Fig. 4-8-2-3.

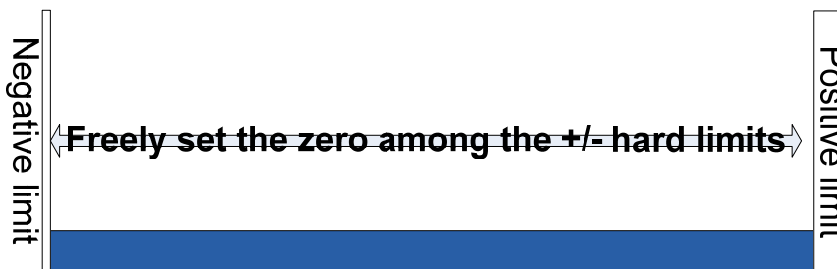

Fig. 4-8-2-3 Zero setting of the absolute encoder

Note 1: Never attempt to operation the mechanical zero if the machine tool does not install the zero deceleration switch or does not set the mechanical zero.

Note 2: The corresponding axis’s indicator lights up when ends of the mechanical zero return.

Note 3: The zero return indicator lights off when the corresponding axis does not on the mechanical zero.

Note 4: Mechanical point (that is the reference position) direction, refer to the machine user manual made by the

manufacture.

Note 5: Do not modify the zero return direction along with each axis, the feed axis direction and the dimension of the gear ratio after the mechanical zero is set.

● **Related signal**

DECX: Deceleration signal along with the X direction

DECY: Deceleration signal along with the Y direction

DECZ: Deceleration signal along with the Z direction

DEC4: Deceleration signal along with the 4th axis

DEC5: Zero return signal along with the 5th axis

Parameter diagnosis (Input state at the machine side)

State add.					X1.3	X1.2	X1.1	X1.0
Pin					XS40.22	XS40.09	XS40.21	XS40.08

State add.								X5.0
Pin								XS42.08

System parameter number

0	0	5			HSRZ			
----------	----------	----------	--	--	-------------	--	--	--

HSRZ =1: High velocity zero return enabled.
 =0: High velocity zero return disabled.

System parameter number

0	0	6	MAOB	ZPLS		SJZ		ZMOD	
----------	----------	----------	-------------	-------------	--	------------	--	-------------	--

ZMOD =1: Before the zero return mode selection block
 =0: After the zero return mode selection block

SJZ =1: Memorize the reference position
 =0: Do not memory the reference position

ZPLS =1: Zero return mode selection: with one-turn signal
 =0: Zero mode selection: without one-turn signal

MAOB =1: The zero return mode selects method B when there is no one-turn signal.
 =0: The zero return mode selects method A when there is no one-turn signal.

System parameter number

0	0	7			ZMI5	ZMI4	ZMI3	ZMI2	ZMI1
----------	----------	----------	--	--	-------------	-------------	-------------	-------------	-------------

- ZMI1** =1: Set the reference position direction return along with the 1st axis:
negative
=0: Set the reference position direction return along with the 1st axis:
positive
- ZMI2** =1: Set the reference position direction return along with the 2nd axis:
negative
=0: Set the reference position direction return along with the 2nd axis:
positive
- ZMI3** =1: Set the reference position direction return along with the 3rd axis:
negative
=0: Set the reference position direction return along with the 3rd axis:
positive
- ZMI4** =1: Set the reference position direction return along with the 4th axis:
negative
=0: Set the reference position direction return along with the 4th axis:
positive
- ZMI5** =1: Set the reference position direction return along with the 5th axis:
negative
=0: Set the reference position direction return along with the 5th axis:
positive

System parameter number

0	2	0	UHSM	APC	MAPC				
---	---	---	------	-----	------	--	--	--	--

- MAPC** =1: Select the multi-coil absolute encoder
=0: Select the single-coil absolute encoder
- APC** =1: Use the absolute encoder
=0: Do not use the absolute encoder
- UHSM** =1: Directly set the machine zero point by hand.
=0: Do not set the machine zero by hand.

Data parameter No.99

0	9	9	The (FL) velocity when gaining the pulse Z signal (All axle current)
---	---	---	--

Data parameters No.100~No.104

1	0	0	Reference position velocity return along with the 1 st axis
1	0	1	Reference position velocity return along with the 2 nd axis
1	0	2	Reference position velocity return along with the 3 rd axis
1	0	3	Reference position velocity return along with the 4 th axis
1	0	4	Reference position velocity return along with the 5 th axis

Data parameters No.342~No.346

3	4	2	Zero return low speed velocity along with the 1 st axis
3	4	3	Zero return low speed velocity along with the 2 nd axis
3	4	4	Zero return low speed velocity along with the 3 rd axis
3	4	5	Zero return low speed velocity along with the 4 th axis
3	4	6	Zero return low speed velocity along with the 5 th axis

Data parameters No.352~No.353

3	5	2	Acceleration/deceleration time constant of the zero return high velocity
3	5	3	Acceleration/deceleration time constant of the zero return low velocity

Data parameter No.354

3	5	4	The low velocity ratio of the machine zero when returning from the zero return deceleration stop
---	---	---	--

Data parameter No.180~No.183

1	8	0	The offset value of the grating or reference position along with the 1 st axis
1	8	1	The offset value of the grating or reference position along with the 2 nd axis
1	8	2	The offset value of the grating or reference position along with the 3 rd axis
1	8	3	The offset value of the grating or reference position along with the 4 th axis

Data parameter No.347~No.351

3	4	7	The reference position absolute position along with the 1 st axis using the absolute rotation encode.
3	4	8	The reference position absolute position along with the 2 nd axis using the absolute rotation encode.
3	4	9	The reference position absolute position along with the 3 rd axis using the absolute rotation encode.
3	5	0	The reference position absolute position along with the 4 th axis using the absolute rotation encode.
3	5	1	The reference position absolute position along with the 5 th axis using the absolute rotation encode.

4.9 Input/Output Signal Control of Spindle Positive/Negative

- Related signal
 - M03: Spindle positive
 - M04: Spindle negative
 - M05: Spindle stop
 - SON: Spindle enabling
 - SAR: Spindle velocity arrival
 - ZSP: Spindle zero detection
 - COIN: Spindle orientation in-position

Parameter diagnosis (output state at the system side)

State add.								Y6.1	Y6.0
Pin No.								XS23.25	XS23.09

Y6.0= the spindle positive signal output; Y6.1= the spindle negative signal output.

State add.								Y6.2	
Pin No.								XS23.24	

Y6.2= Spindle enabling.

Parameter diagnosis (input state at the machine side)

State add.					X7.3	X7.2			
Pin No.					XS23.20	XS23.05			

X7.2= spindle velocity arrival signal input; X7.3=spindle zero velocity detection signal input.

State add.								X7.1	X7.0
Pin No.								XS23.21	XS23.44

X7.0= Velocity/position shifting completion signal; X7.1= Spindle orientation completion signal

System parameter number

0	3	8	PG2	PG1					
----------	----------	----------	------------	------------	--	--	--	--	--

PG2 and PG1 The gear ratio between the spindle and the position encoder.

$$Gear\ ratio = \frac{Position\ encoder\ rotation\ ratio}{Spindle\ rotation\ ratio}$$

Gear ratio	PG2	PG1
×1	0	0
×2	0	1
×4	1	0
×8	1	1

System parameter number

0	4	4						VGR	
----------	----------	----------	--	--	--	--	--	------------	--

VGR =1: The gear ratio of the spindle and position encoder can be performed freely.

=0: Do not freely perform the gear ratio between the spindle and position encoder.

Data parameter No.257

2	5	7	Spindle rotation upper-limit during tapping cycle						
----------	----------	----------	---	--	--	--	--	--	--

Data parameter No.258

2	5	8	Spindle rotation upper-limit						
----------	----------	----------	------------------------------	--	--	--	--	--	--

Data parameters No.286~No.288

2	8	6	Gear number at the side of the spindle side (the 1 st shelf gear)
2	8	7	Gear number at the side of the spindle side (the 2 nd shelf gear)
2	8	8	Gear number at the side of the spindle side (the 3 rd shelf gear)

Data parameters No.290~No.292

2	9	0	Gear number at the side at the encoder side (the 1 st shelf gear)
2	9	1	Gear number at the side at the encoder side (the 2 nd shelf gear)
2	9	2	Gear number at the side at the encoder side (the 3 rd shelf gear)

● Motion time-sequence

Refer to the Fig. 4-9-1 for the spindle motion time-sequence:

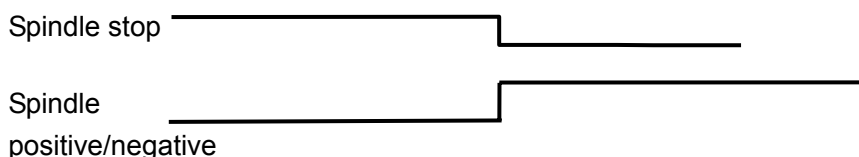

Fig. 4-9-1 Spindle negative time-sequence

● Control logic

- ① Spindle stops when the system power-on, M05 signal output hold;
- ② M3/M4 are enabled and held after performing the M3/M4 codes, and the M05 signal closes to output;

4.10 Spindle Automatic Gear-shift Control

● Relative signal

Y3.4~Y3.6: Spindle automatic gear-shift output signal

X4.1~X4.3: Spindle gear-shift in-position signal

This system supports 3 shelves spindle automatic gear-shift control and 3 shelves gear-shift in-position detection function when the spindle frequency-conversion control is performed (0~10V analog voltage output).

● Signal diagnosis

Parameter diagnosis (output state at the system side)

State add.		Y3.6	Y3.5	Y3.4				
Pin No.		XS44.25	XS44.12	XS44.24				

Y3.4=the spindle gear I output; Y3.5= the spindle gear II output; Y3.6= The spindle gear III output.

Parameter diagnosis (Input state at the machine side)

State add.					X4.3	X4.2	X4.1	
-------------------	--	--	--	--	-------------	-------------	-------------	--

Pin No.					XS42.15	XS42.02	XS42.14	
---------	--	--	--	--	---------	---------	---------	--

X4.1= the spindle gear I in-position; X4.2= the spindle gear II in-position; X4.3= the spindle gear III in-position.

- Control parameter

State parameter

0	0	1					SPT		
---	---	---	--	--	--	--	-----	--	--

- SPT** =1: The spindle control type: I/O point control.
=0: The spindle control type: frequency-conversion or other modes.

Data parameters No.246

2	4	6	The top rotation velocity corresponding the gear 1						
---	---	---	--	--	--	--	--	--	--

The spindle rotation velocity when the frequency transformer is corresponding to the 10V at the spindle gear 1.

Data parameters No.247

2	4	7	The top rotation velocity corresponding the gear 1						
---	---	---	--	--	--	--	--	--	--

The spindle rotation velocity when the frequency transformer is corresponding to the 10V at the spindle gear 2.

Data parameters No.248

2	4	8	The top rotation velocity corresponding the gear 1						
---	---	---	--	--	--	--	--	--	--

The spindle rotation velocity when the frequency transformer is corresponding to the 10V at the spindle gear 3.

Data parameters No.250

2	5	0	Motor velocity when shifting the spindle gear						
---	---	---	---	--	--	--	--	--	--

The velocity related to the data parameter 251

Data parameters No.251

2	5	1	The top rotation velocity of the motor when shifting the spindle gear						
---	---	---	---	--	--	--	--	--	--

The motor's velocity when the frequency transformer is corresponding to the 10V voltage.

- Note:**
1. K8.4 sets to 1 when the automatic shifting equipment is installed in the machine; otherwise, it sets to 0. The Max. rotation velocity of the gear 1 is regarded as default and guarantee $246 \geq 247 \geq 248$ when the automatic gear-shift function is disabled.
 2. K9.3 sets to 1, otherwise, 0 when there is no detection switch on the spindle gear inspection.
 3. K4.0 should be set to 1 when spindle is I/O point control.

4.11 External Cycle Start & Feed Hold

- Relative signal

ST: The external automatic cycle start signal is same to its function on the machine panel.

*SP: The feed hold signal is same to its function on the machine panel.

- Signal diagnosis

Parameter diagnosis (Input state at the system side)

State add.		X1.6	X1.5				
Pin No.		XS40.25	XS40.12				

X1.5=External cycle start; X1.6=External feed hold.

- Signal internal connection

*SP/ST signal internal circuit, refer to the Fig. 4-11-1:

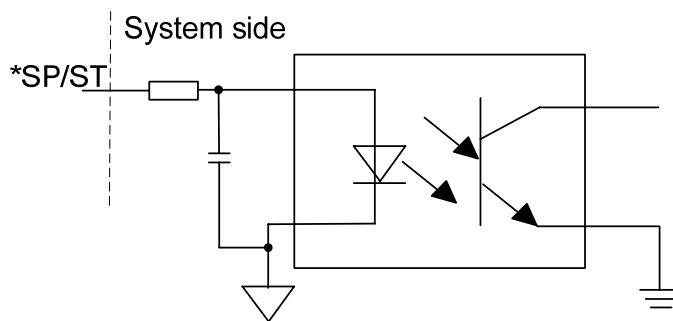

Fig. 4-11-1

- External connection circuit

*SP, ST single external connection shows in the Fig. 4-11-2.

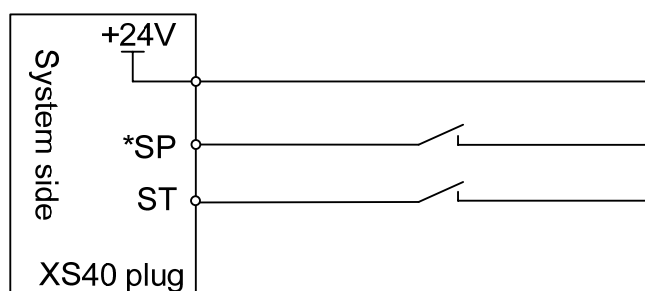

Fig. 4-11-2

- Modify the following parameters

Add.	Meaning	State 0	State 1	Setting value
K005.1	Whether the machine is with the external cycle start	Without	With	1

4.12 External Editing Lock and the External Operation Panel Lock

- Relative signal

LEDT: The external editing lock signal. When the signal is 1, the program can be edited, and it is same as the function of the program switch on the system.

LSYS: The external operation panel lock signal. When the signal is 1, the overall operation keys on the machine are locked.

Signal address

	#7	#6	#5	#4	#3	#2	#1	#0
G016	LSYS	LEDT						

Parameter diagnosis (Input state at the side of the system)

State add.							X3.1	X3.0
Pin No.							XS41.21	XS41.8

X3.0= External editing lock; X3.1= External operation panel lock.

System parameter number

0	5	9		LEDT	LOPT				
----------	----------	----------	--	-------------	-------------	--	--	--	--

- LOPT** =1: Use the external operation panel lock.
=0: Do not use the external operation panel lock.
- LEDT** =1:Use the external editing lock.
=0: Do not use the external editing lock.

4.13 Cooling, Lubrication and Chip-Removal Control

- Relative M code

- M08: Coolant ON
- M09: Coolant OFF
- M35: Chip-removal function ON
- M36: Chip-removal function OFF

- Signal diagnosis

Parameter diagnosis (Output state at the machine side)

State add.							Y0.1	
Pin No.							XS43.14	

Y0.1= Cooling switch control.

Parameter diagnosis (Output state at the machine side)

State add.						Y1.2	Y1.1	
Pin No.						XS43.9	XS43.21	

Y1.1= Chip-removal switch control, Y1.2=Lubrication switch control.

- The internal circuit is shown in the Fig. 4-13-1:

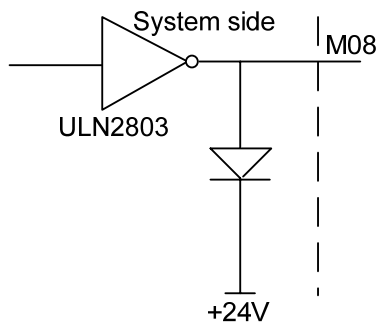

Fig. 4-13-1 M08 internal circuit

4.14 Setting Related to Feedrate

System parameter number

0	1	2	RDR	FDR	TDR	RFO			LRP	RPD
---	---	---	-----	-----	-----	-----	--	--	-----	-----

- RPD** =1: The manual rapid is enabled from the switch-on to the before of reference position return.
 =0: The manual rapid is disabled from the switch-on to the before of reference position return.
- LRP** =1: Positioning (G00) interpolation type is linear.
 =0: Positioning (G00) interpolation type is non-linear.
- RFO** =1: Rapid feed, It stops when its feedrate is F0.
 =0: Rapid feed, It holds when its feedrate is F0.
- TDR** =1: The dry run is enabled during tapping.
 =0: The dry run is disabled during tapping.
- FDR** =1: The dry run is enabled during cutting feed.
 =0: The dry run is disabled during cutting feed.
- RDR** =1: The dry run is enabled during rapid positioning.
 =0: The dry run is disabled during rapid positioning.

0086	Dry run velocity	5000
------	------------------	------

Setting range: 0~9999 (mm/min)

0087	Cutting feedrate when the power is turned on	300
------	--	-----

Setting range: 0~9999 (mm/min)

0088	G0 rapid traverse rate along with the 1 st axis	5000
------	--	------

Setting range: 0~9999 (mm/min)

0089	G0 rapid traverse rate along with the 2 nd axis	5000
------	--	------

Setting range: 0~9999 (mm/min)

0090	G0 rapid traverse rate along with the 3 rd axis	5000
------	--	------

Setting range: 0~9999 (mm/min)

0091	G0 rapid traverse rate along with the 4 th axis	5000
------	--	------

Setting range: 0~9999 (mm/min)

0092	G0 rapid traverse rate along with the 5 th axis	5000
------	--	------

Setting range: 0~9999 (mm/min)

0093	Fo velocity of the rapid traverse override along with each axis (all axle are in current)	30
------	---	----

Setting range: 0~1000 (mm/min)

0094	The Max. feedrate at the rapid positioning (all axle are in current)	8000
------	--	------

Setting range: 300~30000 (mm/min)

0095	The Min. feedrate at the rapid positioning (all axle are in current)	0
------	--	---

Setting range: 0~300 (mm/min)

0096	The Max. control velocity in the cutting feed (all axle are in current)	6000
------	---	------

Setting range: 300~9999 (mm/min)

0097	The Min. control velocity in the cutting feed (all axle are in current)	0
------	---	---

Setting range: 0~300 (mm/min)

0098	The feedrate in JOG consecutive feed along with each axis	2000
------	---	------

Setting range: 0~9999 (mm/min)

0099	FL velocity (All axle are in current) when capturing	40
------	--	----

	the pulse Z signal	
--	--------------------	--

Setting range: 1~60 (mm/min)

0100	Reference position return velocity along with the 1 st axis	4000
------	--	------

Setting range: 0~9999 (mm/min)

0101	Reference position return velocity along with the 2 nd axis	4000
------	--	------

Setting range: 0~9999 (mm/min)

0102	Reference position return velocity along with the 3 rd axis	4000
------	--	------

Setting range: 0~9999 (mm/min)

0103	Reference position return velocity along with the 4 th axis	4000
------	--	------

Setting range: 0~9999 (mm/min)

0104	Reference position return velocity along with the 5 th axis	4000
------	--	------

Setting range: 0~9999 (mm/min)

0170	Manual rapid positioning velocity along with the 1 st axis	5000
------	---	------

Setting range: 0~30000 (mm/min)

0171	Manual rapid positioning velocity along with the 2 nd axis	5000
------	---	------

Setting range: 0~30000 (mm/min)

0172	Manual rapid positioning velocity along with the 3 rd axis	5000
------	---	------

Setting range: 0~30000 (mm/min)

0173	Manual rapid positioning velocity along with the 4 th axis	5000
------	---	------

Setting range: 0~30000 (mm/min)

0174	Manual rapid positioning velocity along with the 5 th axis	5000
------	---	------

Setting range: 0~30000 (mm/min)

4.15 Setting Related with Tapping Parameter

Positioning parameter number

0	4	4			PCP	DOV			VGR	
---	---	---	--	--	-----	-----	--	--	-----	--

VGR =1: The gear ratio of the spindle and the position encoder can be random.

=0: The gear ratio of the spindle and the position encoder can not be random.

DOV =1: The override is enabled during the rapid tapping retraction.

=0: The override is disabled during the rapid tapping retraction.

PCP =1: The tapping is high velocity deep peck tapping cycle.

=0: The tapping is standard deep peck tapping cycle.

System parameter number

0	4	5				OVS	OVU	TDR		NIZ
---	---	---	--	--	--	------------	------------	------------	--	------------

NIZ =1: Perform the smooth processing for rigid tapping

=0: Do not perform the smooth processing for rigid tapping

TDR =1: Use the identical time constant when the rigid tapping performs infeed/retraction.

=0: Do not use the identical time constant when the rigid tapping performs infeed/retraction.

OVU =1: Rigid tapping retraction override 10%

=0: Rigid tapping retraction override 1%

OVS =1: The feedrate override selection and override cancellation signal in the rigid tapping are enabled.

=0: The feedrate override selection and override cancellation signal in the rigid tapping are disabled.

System parameter number

0	4	6			ORI				SSOG	
---	---	---	--	--	------------	--	--	--	-------------	--

SSOG =1: The spindle control mode is servo when the tapping starts.

=0: The spindle control mode is follow when the tapping starts.

ORI =1: The spindle performs the exact stop when tapping starts.

=0: The spindle does not perform the exact stop when tapping starts.

K parameter number

0	0	7	PAP							
---	---	---	------------	--	--	--	--	--	--	--

DGN =1: Use the spindle position mode.

=0: Do not use the spindle position mode.

It is set to 1 when using the rigid tapping, and set to 0 when using the flexible tapping.

Appendix: The setting method of rigid and flexible tapping when GSK218MC system matches with DAP03 spindle servo drive unit

Precautions:

(1) 218MC must be matched with the DAP03 spindle servo drive unit when it is performed the rigid tapping.

(2) 218MC should be correctly connected with the DAP03 spindle servo drive unit when it is performed the rigid tapping.

Setting processing:

A. Rigid tapping setting: Use the system default parameter; and only the following parameters can be altered.

1. Bit parameter: **NO:46#1** changes into 1 (Servo mode)
2. PLC parameter: **K7#7** changes into 1 (User the spindle position mode).
3. Data parameter: The upper limit velocity of the **P257** parameter set into consistent with the one of the spindle.
4. Data parameter: The P294 parameter tapping corresponding to the gear 1 velocity is set to the same with the tapping upper limit one.
5. The parameter PA4 in the DAP03 parameter is set to 5. (Velocity and position shifting mode)
6. The spindle's rotation direction is inconsistent with the one of the command when performing the rigid tapping command, it is better to set the PA15 in the DAP03 into 1.
7. Data parameter: The linear acceleration/deceleration time constant of both the P298 spindle and tapping axis are altered into 300.
8. Data parameter: The time constant both the spindle and tapping axis are altered into 300 when P302 retracts.
9. It is supposed to shift the position mode, when the spindle rotation velocity is inconsistent with the one of the command, the data parameter P323 and P326 can be modified, or alter the PA12 and PA13 in DAP03 parameter, and then calculate the electric gear ratio based upon the formula $P \cdot G = N \cdot C \cdot 4$.
 - P: Input the pulse number of the code
 - G: Electric gear ratio
 - N: The circles of the motor rotation
 - C: Photoelectric encoder resolution
10. When the gear ratio between the spindle and motor is not 1:1, the corresponding gear ratio that inputs the PA35, PA36 in the DAP03 should be calculated out.
11. The positive/negative of the spindle should be guaranteed consistent with the rotation direction of the tapping when tapping. The revolving wave should not be too much, and it is better to control the error within 3 rotations.

12. It is better to use the spiral tapping with the dedicated coolant for cutting some soft materials (such as the aluminum alloy, copper)

B. Flexible tapping setting: There are two methods to carry out the flexible tapping.

1. In the position control mode (that is, parameter **NO:46#1** turns into 1(servo mode), **K7#7** becomes 1 (Use the spindle position mode)), use the code M03/M04 can be carried out the flexible tapping.
2. In the velocity control mode (that is, parameter **NO:46#1** turns into 0 (following mode), **K7#7** becomes 0 (Do not use the spindle position mode)), it also uses the M03/M04 code, which can be carried out the flexible tapping.

During tapping, specify a tapping to the bottom of the hole in programming, it is better to dwell 1s or 2s.

Note: The above-mentioned are corresponding to the machine setting methods of the shifting without gears.

4.16 Setting for the 4th Axis

GSK218MC series owns 4-axis & 4-liange function.

The data parameter P5 sets to 4; the 4th axis function of the system is enabled after the system restarts again.

Relative bit parameter:

System parameter number

0	0	9								A4TP	RAB
---	---	---	--	--	--	--	--	--	--	-------------	------------

- RAB** =1: That each axis regards as the rotation axis rotates nearby
=0: That each axis regards as the rotation axis does not rotate nearby
- A4TP** =1: Set it as the 4-axis linkage system
=0: Do not set it as the 4-axis linkage system

System parameter number

0	0	8						AXS4			
---	---	---	--	--	--	--	--	-------------	--	--	--

- AXS4** =1: The 4th axis is set to rotation axis.
=0: The 4th axis is set to linear axis.

System parameter number

0	5	0		SIM		G90				REL	
---	---	---	--	------------	--	------------	--	--	--	------------	--

- REL** =1: The relative position display setting of the index worktable: within 360°.
REL
=0: The relative position display setting of the index worktable: without 360°.

- G90** =1: Index command: absolute command.
 =0: Index command: G90/G91 command
- SIM** =1: The index code and other control axis code alarm when they are shared with a same block.
 0: The index code and other control axis code are not alarm when they are shared with a same block.

Relative data parameter:

Table 4-16-1

Series No.	Default numerical No.	Resolution range	Parameter meaning
0005	4	3~5	CNC controllable axis number
0178	3	0~8	The program name of the 4 th axis (0~8: X,Y,Z,A,B,C,U,V,W)

The releasing/clamping function of the 4th axis

The index worktable clamping/releasing equipment is controlled by system PLC. When the index worktable clamping/releasing equipment is used, the corresponding K parameter can be set based upon the actual situations; refer to the following:

Relative K parameters:

Table 4-16-2

Add.	Definition	Default value	Setting value
K014.0	Whether use the index worktable clamping/releasing equipment	0 (Do not use the clamping/releasing equipment)	1 (Use the clamping/releasing equipment)
K014.1	Whether the worktable index is automatic clamping/releasing	0 (Without automatic releasing/clamping)	1 (Automatic clamping/releasing)
K014.2	Whether the worktable clamping/releasing is without detection switch	0 (With inspection switch)	1 (Without inspection switch)
K014.3	Index worktable prohibits the manual MPG single block	0 (Permit the manual MPG single step)	1 (Prohibit manual MPG single step)
K014.4	Whether the index releasing state allows to move the XYZ axes	0 (Prohibit moving XYZ axes)	1 (Permit moving XYZ axes)
K014.5	Whether the index worktable is out of output after it is released/clamped	0 (Hold output)	1 (Output OFF)

1. The system provides two methods to carry out when the 4th axis is with the automatic releasing/clamping function:

- ① The releasing/clamping control of the 4th axis can be carried out by M code.

Related definition:

M10 F0312 Axis A clamping

M11 F0313 Axis A releasing

- ② The automatic releasing/clamping of the 4th axis can be controlled by judging the operation command inside the system after modifying PLC parameter K14.1=1.

Processing: Perform A axis to command → System issues F signal, PLC that after retreatment outputs Y1.6 makes the worktable releasing, after the releasing is in-position → System perform axis A motion, after the axis A command performs → System issues the F signal, PLC that after retreatment outputs Y1.7 makes the worktable clamping, the system continues performing the following programming after the clamping in-position is completed.

2. PLC relative address:

Table 4-16-3

Definition	Diagnosis Add.	Diagnosis interface	Single interface	Interface pin
Index worktable releasing	Y001.6	Diagnosis (PLC→MT)	XS43	25
Index worktable clamping	Y001.7	Diagnosis (PLC→MT)	XS43	13
Index worktable releasing inspection	X002.2	Diagnosis (MT→PLC)	XS41	2
Index worktable clamping inspection	X002.3	Diagnosis (MT→PLC)	XS41	15

4.17 Setting About the Bus Servo

System parameter number

0	0	0		SVCD		MSP	CPB			PBUS
---	---	---	--	------	--	-----	-----	--	--	------

PBUS =1: The transmission method of driver: bus

=0: The transmission method of driver: pulse

CPB =1: Pulse and Ethernet are used at the same time.

=0: Pulse and Ethernet are not used at the same time.

MSP =1: Use the double spindle control
 =0: Do not use the double spindle control

SVCD =1: Use the axis extension card
 =0: Do not use the axis extension card

System parameter number

0	0	1	RAS5	RAS4	RAS3	RAS2	RAS1		SBUS	RASA
---	---	---	-------------	-------------	-------------	-------------	-------------	--	-------------	-------------

RASA =1: Use the absolute grating rule
 =0: Do not use the absolute grating rule

SBUS =1: Spindle driver is the bus control method
 =0: Spindle driver is not the bus control method

RAS1 =1: Set the 1st axis with the grating rule
 =0: Set the 1st axis without the grating rule

RAS2 =1: Set the 2nd axis with the grating rule
 =1: Set the 2nd axis without the grating rule

RAS3 =1: Set the 3rd axis with grating rule
 =1: Set the 3rd axis without the grating rule

RAS4 =1: Set the 4th axis with grating rule
 =0: Set the 4th axis without grating rule

RAS5 =1: Set the 5th axis with grating rule
 =0: Set the 5th axis without grating rule

System parameter number

0	0	5	DOUS							
---	---	---	-------------	--	--	--	--	--	--	--

DOUS =1: Dual-drive tool with grating position
 =0: Dual-drive tool without grating position

System parameter number

0	2	0	UHSM	APC	MAPC					
---	---	---	-------------	------------	-------------	--	--	--	--	--

MAPC =1: Select the multi-coil absolute encoder
 =0: Select the single-coil absolute encoder

APC =1: Use the absolute encoder
 =0: Do not use the absolute encoder

UHSM =1: Directly set the machine zero by hand

=0: It can not be directly set the machine zero by hand

System parameter number

0	2	1				APZ5	APZ4	APZ3	APZ2	APZ1
---	---	---	--	--	--	------	------	------	------	------

APZ1 =1: The current machine position along with the 1st axis is set as machine zero.
 =0: The current machine position along with the 1st axis does not set as machine zero.

APZ2 =1: The current machine position along with the 2nd axis is set as machine zero.
 =0: The current machine position along with the 2nd axis does not set as machine zero.

APZ3 =1: The current machine position along with the 3rd axis is set as machine zero.
 =0: The current machine position along with the 3rd axis does not set as machine zero.

APZ4 =1: The current machine position along with the 4th axis is set as machine zero.
 =0: The current machine position along with the 4th axis does not set as machine zero.

APZ5 =1: The current machine position along with the 5th axis is set as machine zero.
 =0: The current machine position along with the 5th axis does not set as machine zero.

Data parameter number

0008	Ethernet bus slave-station MDT data package size	16
------	--	----

Setting range: 2, 4, 6, 8, 10, 12, 14, 16 and 20

Note: Never attempt to modify this parameter other than the professionals.

0009	The Max. repeated times of the Ethernet bus	10
------	---	----

Setting range: 0~30

Note: Never attempt to modify this parameter other than the professionals.

0347	The absolute position of the 1 st axis reference point when using the absolute rotation encoder.	65000
------	---	-------

Setting range: 0~131071

0348	The absolute position of the 2 nd axis reference point when using the absolute rotation encoder.	65000
------	---	-------

Setting range: 0~131071

0349	The absolute position of the 3 rd axis reference point	65000
------	---	-------

	when using the absolute rotation encoder.	
--	---	--

Setting range: 0~131071

0350	The absolute position of the 4 th axis reference point when using the absolute rotation encoder.	65000
------	---	-------

Setting range: 0~131071

0351	The absolute position of the 5 th axis reference point when using the absolute rotation encoder.	65000
------	---	-------

Setting range: 0~131071

0380	Set the synchronism axis with the 4 th axis 0: Failure to synchronism with any axis 1: The 1 st axis 2: The 2 nd axis 3: The 3 rd axis	0
------	--	---

Setting range: 0~3

0381	The Max. permission error between the synchronism axes	200
------	--	-----

Setting range: 0~10000

0382	Set the dual-drive reference position D-value	200
------	---	-----

Setting range: 0~2000

0392	The movement distance when the servo optimizes	50
------	--	----

Setting range: 0~100

0393	The travel rate when the servo optimizes	2000
------	--	------

Setting range: 0~5000

0444	The Max. permission error between the machine coordinate along with each axis and the absolute encoder position	50
------	---	----

Setting range: 0~500

0445	Axis 1 configuration with grating accuracy	0.0010
------	--	--------

Setting range: 0~500

0446	Axis 2 configuration with grating accuracy	0.0010
------	--	--------

Setting range: 0~500

0447	Axis 3 configuration with grating accuracy	0.0010
------	--	--------

Setting range: 0~500

0448	Axis 4 configuration with grating accuracy	0.0010
------	--	--------

Setting range: 0~500

0449	Axis 5 configuration with grating accuracy	0.0010
------	--	--------

Setting range: 0~500

0450	Machine stroke detection: the absolute position at the boundary of the 1 st encoder along with negative direction	0
------	--	---

Setting range: -99999.9999~99999.9999

0451	Machine stroke detection: the absolute position at the boundary of the 1 st encoder along with positive direction	0
------	--	---

Setting range: -99999.9999~99999.9999

0452	Machine stroke detection: the absolute position at the boundary of the 2 nd encoder along with negative direction	0
------	--	---

Setting range: -99999.9999~99999.9999

0453	Machine stroke detection: the absolute position at the boundary of the 2 nd encoder along with positive direction	0
------	--	---

Setting range: -99999.9999~99999.9999

0454	Machine stroke detection: the absolute position at the boundary of the 3 rd encoder along with negative direction	0
------	--	---

Setting range: -99999.9999~99999.9999

0455	Machine stroke detection: the absolute position at the boundary of the 3 rd encoder along with positive direction	0
------	--	---

Setting range: -99999.9999~99999.9999

0456	Machine stroke detection: the absolute position at the boundary of the 4 th encoder along with negative direction	0
------	--	---

Setting range: -99999.9999~99999.9999

0457	Machine stroke detection: the absolute position at the boundary of the 4 th encoder along with positive direction	0
------	--	---

Setting range: -99999.9999~99999.9999

0458	Machine stroke detection: the absolute position at the boundary of the 5 th encoder along with negative direction	0
------	--	---

Setting range: -99999.9999~99999.9999

0459	Machine stroke detection: the absolute position at the boundary of the 5 th encoder along with positive direction	0
------	--	---

Setting range: -99999.9999~99999.9999

APPENDIX

APPENDIX I LADDER DIAGRAM USAGE GUIDE OF GSK218MC SERIES WITH CONE TYPE TOOL-MAGAZINE

I. Cautions When Using the Cone Type Tool-Magazine Ladder Diagram

1. It is necessary to strictly install the circuit based upon the requirements when using the ladder diagram.
2. It is important to correctly set the PLC parameter when using this ladder diagram, so that the ladder diagram is consistent with the machine equipment.
3. If the machine has the special control requirements, the program should be added in the ladder diagram, which requires the technicians have the electrical and PLC knowledge and learn the ladder diagram very well.
4. The ladder diagram is only suitable for the common CNC milling machine or the machining center with cone type tool-magazine. It may cause the unexpected hazard occur if other machine tools are equipped.
5. This ladder diagram is only for reference; the ladder diagrams are differed from the one machine to another.

II. Configuration and Definition of PLC I/O Address and Internal Software Components

Table 1 the definition of input signal interface

Add.	Signal interface	Interface pin	Definition	Contact selection
X000.0	XS40	1	+ stroke limit signal along with the 1 st axis	NC contact
X000.1	XS40	14	- stroke limit signal along with the 1 st axis	NC contact
X000.2	XS40	2	+ stroke limit signal along with the 2 nd axis	NC contact
X000.3	XS40	15	- stroke limit signal along with the 2 nd axis	NC contact
X000.4	XS40	17	+ stroke limit signal along with the 3 rd axis	NC contact
X000.5	XS40	5	- stroke limit signal along with the 3 rd axis	NC contact
X000.6	XS40	18	+ stroke limit signal along with the 4 th axis	NC contact
X000.7	XS40	6	- stroke limit signal along with the 4 th axis	NC contact

Add.	Signal interface	Interface pin	Definition	Contact selection
X001.0	XS40	8	Zero return deceleration signal along with the 1 st axis	NC contact
X001.1	XS40	21	Zero return deceleration signal along with the 2 nd axis	NC contact
X001.2	XS40	9	Zero return deceleration signal along with the 3 rd axis	NC contact
X001.3	XS40	22	Zero return deceleration signal along with the 4 th axis	NC contact
X001.4	XS40	24	ESP switch (218MC integration)	NC contact
X001.5	XS40	12	External cycle start	NORM contact
X001.6	XS40	25	External feed hold	NORM contact
X001.7	XS40	13	Lubrication press or grease level inspection	NORM contact
X002.0	XS41	1	Air resource pressure inspection	NORM contact
X002.1	XS41	14	Skip signal	NORM contact
X002.2	XS41	2	Index worktable releasing inspection	NORM contact
X002.3	XS41	15	Index worktable clamping inspection	NORM contact
X002.4	XS41	17	External clamping/releasing control	NORM contact
X002.5	XS41	5	Tool-releasing inspection	NORM contact
X002.6	XS41	18	Tool-clamping inspection	NORM contact
X002.7	XS41	6	Spindle tool inspection switch	Parameter appointment
X003.0	XS41	8	Edit lock	NORM contact
X003.1	XS41	21	Operation lock	NORM contact
X003.2	XS41	9	Undefined	
X003.3	XS41	22	Undefined	
X003.4	XS41	24	Undefined	
X003.5	XS41	12	Undefined	
X003.6	XS41	25	Undefined	
X003.7	XS41	13	Undefined	
X004.0	XS42	1	Undefined	
X004.1	XS42	14	Spindle gear I in-position	NORM contact
X004.2	XS42	2	Spindle gear II in-position	NORM contact
X004.3	XS42	15	Spindle gear III in-position	NORM contact
X004.4	XS42	17	Undefined	
X004.5	XS42	5	Safety door inspection switch	NORM contact
X004.6	XS42	18	Undefined	
X004.7	XS42	6	Undefined	
X005.0	XS42	8	Zero return signal inspection along with the 5 th axis	Parameter appointment
X005.1	XS42	21	Tool-magazine forward in-position	Parameter appointment
X005.2	XS42	9	Tool-magazine backward in-position	Parameter

Add.	Signal interface	Interface pin	Definition	Contact selection
				appointment
X005.3	XS42	22	Tool magazine counting switch	Parameter appointment
X005.4	XS42	24	Tool-magazine zero return in-position	Parameter appointment
X005.5	XS42	12	Current cutter-head tool inspection switch	Parameter appointment
X005.6	XS42	25	+ stroke limit signal along with the 5 th axis	NC contactor
X005.7	XS42	13	- stroke limit signal along with the 5 th axis	NC contactor
X006.0	XS22	5	The 1 st axle-selection of the external MPG	NORM contact
X006.1	XS22	23	The 2 nd axle-selection of the external MPG	NORM contact
X006.2	XS22	6	The 3 rd axle-selection of the external MPG	NORM contact
X006.3	XS22	24	The 4 th axle-selection of the external MPG	NORM contact
X006.4	XS22	25	External MPG step length 0.001	NORM contact
X006.5	XS22	8	External MPG step length 0.01	NORM contact
X006.6	XS22	26	External MPG step length 0.1	NORM contact
X006.7	XS22	ESP(9,22)	External ESP	NC contactor
X007.0	XS23	44	Velocity/position shifting completion	Parameter appointment
X007.1	XS23	21	Spindle orientation completion	Parameter appointment
X007.2	XS23	5	Spindle velocity arrival	Parameter appointment
X007.3	XS23	20	Spindle zero speed inspection	NC contactor
X008.0	XS22	7	The 5 th axle-selection of the external MPG	NORM contact

Appendix

Precautions:

1. Refer to the Chapter Four for the connection and caution of the PLC input part (X).
2. The contacts are classified into the four types: Normally open contact, NC contact, whether the contact is normally open or NC is set by the parameters. Among them, that the input points are connected with NORM or NC contacts are set by KAPA parameter in PLC. About the details, refer to KAPA parameter introduction.
3. User can add a new function (The ladder diagram should be modified when using the undefined part, it is better to carefully operate) to the undefined input part when using this ladder diagram.
4. Operation panel USER1 there are 3 functions when the button on the 218MC.
 - When K11.0=0:
 - a. If the 5th axis is opened, it is the 5th axis positive button.
 - b. If the 5th axis does not open, it is the Washing-chip control switch
 - When K11.0=1: The 1st reference position return by hand

USER 1 button has two functions on 218MC-V:

- When K11.0=0, it is the Washing-chip control switch
- When K11.0=1, The 1st reference position return by hand

USER 2 button has two functions on 218MC

- When K11.1=0:
 - a. If the 5th axis does not open, it is the Washing-chip control switch
 - b. If the 5th axis is opened, it is the 5th negative button
- When K11.1=1, The 2nd reference position return by hand

USER 2 button has two functions on 218MC-V:

- When K11.1=0, If the 5th axis does not open, it is the Washing-chip control switch
- When K11.1=1, The 2nd reference position return by hand

The function of the USER3 button: Spindle blowing automatic switch

Table 2 The definition of the output signal interface

Add.	Single interface	Interface pin	Definition
Y000.0	XS43	1	Z axis brake
Y000.1	XS43	14	Cooling
Y000.2	XS43	2	Cutter releasing/clamping
Y000.3	XS43	15	Undefined
Y000.4	XS43	17	Spindle brake
Y000.5	XS43	5	Undefined
Y000.6	XS43	18	Red alarm indicator
Y000.7	XS43	6	Yellow indicator
Y001.0	XS43	8	Green indicator
Y001.1	XS43	21	Chip-removal control
Y001.2	XS43	9	Lubrication control
Y001.3	XS43	22	Machine illumination control
Y001.4	XS43	24	Hydraulic start
Y001.5	XS43	12	Spindle blowing
Y001.6	XS43	25	Index worktable releasing
Y001.7	XS43	13	Index worktable clamping
Y002.0	XS44	1	Undefined
Y002.1	XS44	14	Undefined
Y002.2	XS44	2	Undefined
Y002.3	XS44	15	Undefined
Y002.4	XS44	17	Undefined
Y002.5	XS44	5	Undefined
Y002.6	XS44	18	Washing-chip output
Y002.7	XS44	6	Undefined

Add.	Single interface	Interface pin	Definition
Y003.0	XS44	8	Tool-magazine positive
Y003.1	XS44	21	Tool-magazine negative
Y003.2	XS44	9	Tool-magazine forward
Y003.3	XS44	22	Tool-magazine backward
Y003.4	XS44	24	Spindle gear I (Frequency conversion /IO point control)
Y003.5	XS44	12	Spindle gear II (Frequency conversion /IO point control)
Y003.6	XS44	25	Spindle gear III (Frequency conversion /IO point control)
Y003.7	XS44	13	Undefined
Y004.0	XS45	1	Undefined
Y004.1	XS45	14	Undefined
Y004.2	XS45	2	Undefined
Y004.3	XS45	15	Undefined
Y004.4	XS45	17	Undefined
Y004.5	XS45	5	Undefined
Y004.6	XS45	18	Undefined
Y004.7	XS45	6	Undefined
Y005.0	XS45	8	Undefined
Y005.1	XS45	21	Undefined
Y005.2	XS45	9	Undefined
Y005.3	XS45	22	Undefined
Y005.4	XS45	24	Undefined
Y005.5	XS45	12	Undefined
Y005.6	XS45	25	Undefined
Y005.7	XS45	13	Undefined
Y006.0	XS23	9	Spindle positive
Y006.1	XS23	25	Spindle negative
Y006.2	XS23	24	Spindle enabling
Y006.3	XS23	11	Spindle orientation
Y006.4	XS23	12	Spindle velocity/position shifting
Y006.5	XS23	27	Zero clamping

Precautions:

1. Refer to the Chapter Four for the connection and caution of the PLC input part (Y).
2. User can add a new function (The ladder diagram should be modified when using the undefined part, it is better to carefully operate) to the undefined input part by modifying the ladder diagram when using this ladder diagram.

Table 3 KPAR address definition

Add.	Definition	State 0	State 1
K000.0	PLC parameter modification permission	Prohibition	Permission

Add.	Definition	State 0	State 1
K000.1	PLC signal debugging permission	Prohibition	Permission
K000.2	Clear the overall Y signals when PLC enters the debugging mode.	Not clear	Clear
K000.3	Add. A signal editing permission	Prohibition	Permission
K000.4	Add. K signal editing permission	Prohibition	Permission
K000.5	Add. X signal editing permission	Prohibition	Permission
K000.6	Add. Y signal editing permission	Prohibition	Permission
K000.7	Command table operation permission	Prohibition	Permission
K001.0	Tool-magazine usage permission	Prohibition	Permission
K001.1	Whether automatically download the ladder diagram when conversion.	No	Yes
K001.2	Level selection of the spindle interface input signal	+24v enabling	0v enabling
K002.0	Whether use the 4 th axis	Unused	Used
K002.1	Whether use the 5 th axis	Unused	Used
K004.0	Whether the spindle is used the gear control (I/O point)	Unused	Used
K005.0	Whether the machine is with the external MPG.	Without	With
K005.1	Whether the machine is with the external cycle start	Without	With
K005.2	Whether the system enters the debugging mode	No	Yes
K006.0	Whether use 1 limit switch	2 pcs	1 pc
K006.4	Whether the zero return switch is selected the NORM	No	Yes
K007.3	Whether cancel the 4 th axis hard limit	No	Yes
K007.4	Whether cancel the 5 th axis hard limit	No	Yes
K007.5	Whether cancel the external ESP	No	Yes
K007.6	Whether the spindle outputs the +10V~-10V analog voltage	No	Yes
K007.7	Whether use the spindle position mode	Unused	Used
K008.0	Whether the spindle positioning inspection is NORM (Normally opened)	NC type	NORM type
K008.1	Whether the cutter clamping/releasing is controlled by panel button	External button	Panel button
K008.2	Whether not use the cutter clamping/releasing equipment	Used	Unused
K008.3	Whether use the safety door inspection equipment	NC	NORM
K008.4	Whether the spindle is with the shifting equipment	Without	With
K008.5	Whether the spindle velocity arrival inspection is NC type	NORM type	NC type
K008.6	Whether it is NC type when the spindle velocity mode executes	NORM type	NC type
K008.7	Whether the spindle mode conversion detects signal	With	Without
K009.0	Whether the spindle position arrival detects switch	With	Without
K009.1	Check whether the lubrication pressure or grease level is enabled	Disabled	Enabled
K009.2	Check whether the air source pressure is enabled	Not inspection	Inspection
K010.1	Check whether the tool-magazine is with zero return switch	Without	With

Add.	Definition	State 0	State 1
K010.2	Whether the tool-magazine zero return switch is selected the NC type	NORM type	NC type
K010.3	Whether the tool-magazine infeed switch is selected the NC type	NORM type	NC type
K010.4	Whether the tool-magazine retraction switch is selected the NC type	NORM type	NC type
K010.5	Whether the tool-magazine counting switch is selected the NC type	NORM type	NC type
K010.6	Whether the tool-magazine origin set by hand is enabled	Disabled	Enabled
K010.7	Whether the tool-magazine enters adjustment mode	No	Yes
K011.1	Manual return tool-change position permission	Prohibition	Permission
K011.2	Whether the tool-magazine forward in-position	Connection	Disconnection
K011.5	Whether output the positive signal when spindle is positioned	No	Yes
K012.0	Whether the spindle inspection with cutter is enabled	No	Yes
K012.1	Whether the spindle cutter inspection switch is NC type	No	Yes
K012.2	Whether the current tool-magazine cutter head inspection with cutter are enabled	No	Yes
K012.3	Whether the current cutter head inspection switch is NC type	No	Yes
K014.0	Whether use the index worktable clamping/releasing equipment	No	Yes
K014.1	Whether the worktable index is automatic releasing/clamping	No	Yes
K014.2	Whether the worktable releasing/clamping is without inspection switch	With	Without
K014.3	Index worktable prohibits manual MPG single block	No	Yes
K014.4	Whether the index table releasing state permits moving X Y Z axes	No	Yes
K014.5	Whether cut off the output after the index worktable release the clamping	No	Yes
K014.7	Index worktable enters the debugging mode	No	Yes

Precautions:

1. When the system is normally operated, it is necessary to confirm the states of K000.0, K000.1, K000.2, K000.3, K000.4, K000.5, K000.6, K000.7, K005.2 and K010.7 are 0; otherwise, the unexpected accident may happen.
2. The system can be enabled after its power is turned again until the parameter K001.0 is altered. K010.1, K010.2, K010.3, K010.4, K010.5, K010.6, K010.7, K011.1 and K011.2 are disenabled when K001.0=0 (That is, regardless of using the tool-magazine)
3. The K008.2 is disabled when K001.0=1 (That is, tool-magazine is enabled).

4. The K008.1 is disabled when K008.2=0 (That is, do not use the tool clamping/releasing equipment).
5. The precautions when K006.0 is set.
 - Install 2 stroke limit switches of each axis when K006.0 is set to 0.
 - For example:** install two stroke limit switches along with the X axis (+ limit switch connect with the X0. 0; - one connects with the X0. 1).
 - when K006.0 is set to 1, the stroke limit switch of each axis is only installed one.
 - For example:** install one stroke limit switch along with the X axis (It must be connected with the X0.0).
 - The other installation methods of each axis are identical.
6. The overall alarm interlocking are released when K005.2=1, the system is then entered the debugging mode, which is only use for the system testing. Normally, the parameter should be set to 0, otherwise, unexpected accident may occur.
7. The parameters such as the K010.1, K010.2, K010.3, K010.4, K010.5, K010.6, K010.7, K011.1 and K011.2 are related with the tool magazine; refer to the use of the tool magazine and maintenance at the part III.
8. The setting of the K008.4 (Whether the spindle is with the shifting equipment) is disabled when K004.0 (Whether the spindle is used the I/O point control) =1; that is, the spindle is without the shifting device.

Table four The definition of the PLC external alarm

PLC alarm No.	Add. A	Alarm content
1200	A000.0	Abnormal air pressure detection
1201	A000.1	Abnormal lubrication grease detection
1202	A000.2	Abnormal lubrication motor detection
1203	A000.3	Abnormal cooling motor detection
1204	A000.4	Abnormal chip-removal motor detection
1205	A000.5	Abnormal pressure oil-pump motor detection
1207	A000.7	Abnormal machine tool illumination lamp detection
1208	A001.0	Abnormal machine control cabinet temperature detection
1209	A001.1	Abnormal machine body temperature detection
1210	A001.2	Abnormal machine vibration frequency detection
1211	A001.3	Abnormal pressure grease temperature detection
1212	A001.4	Excessive low grease pressure
1213	A001.5	Fail to ready for the machine tool
1214	A001.6	Spindle shifting abnormal, fail to rotate
1215	A001.7	Firstly perform the T code when executing the M06 code
1216	A002.0	Cutter releasing, fail to rotate the spindle

PLC alarm No.	Add. A	Alarm content
1217	A002.1	Spindle rotates the cutter, fail to release
1218	A002.2	Tool magazine abnormal stop, confirm the tool number again
1219	A002.3	Tool magazine infeed position, fail to rotate the spindle
1220	A002.4	Abnormal spindle cutter clamping detection
1221	A002.5	Abnormal spindle cutter releasing detection
1222	A002.6	Abnormal spindle unit temperature detection
1223	A002.7	Abnormal spindle velocity detection
1224	A003.0	Abnormal spindle motor enabling detection
1225	A003.1	Abnormal spindle orientation in-position detection
1226	A003.2	Spindle gear abnormality
1227	A003.3	Fail to rotate the tool magazine out of the origin
1228	A003.4	Tool magazine in the infeed position, fail to cycle start
1229	A003.5	Set the spindle tool number
1230	A003.6	Failure to tool-change in spindle tool releasing state
1231	A003.7	Failure to tool-change because tool-magazine is out of the retraction place
1232	A004.0	Abnormal tool magazine rotation in-position detection
1233	A004.1	Abnormal tool magazine rotation motor detection
1234	A004.2	Program stops in the tool magazine infeed position
1235	A004.3	Abnormal tool magazine move in-position detection
1236	A004.4	Abnormal tool magazine zero return detection
1237	A004.5	Tool magazine origin position absent, find out it again
1238	A004.6	Abnormal infeed in-position detection
1239	A004.7	Abnormal retraction in-position detection
1240	A005.0	Tool magazine abnormality, zero return again
1241	A005.1	Abnormal tool magazine infeed detection
1242	A005.2	Abnormal tool magazine retraction detection
1243	A005.3	Enabled tool magazine zero position setting
1244	A005.4	Tool change abnormal stop to ensure the tool magazine normal
1245	A005.5	Without code tool number in the cutter table or tool number repeated.
1246	A005.6	Fail to infeed due to the tool magazine is out of the tool-change position
1247	A005.7	Tool magazine can not infeed due to the tool magazine positioning absent
1248	A006.0	Tool magazine can not retract when cutter in the releasing state
1249	A006.1	Spindle can not infeed but with the cutter
1250	A006.2	Fail to infeed because the current tool numbers between spindle and tool magazine are different.
1251	A006.3	Turn off the power
1252	A006.4	Tool clamping can not move the Z axis
1253	A006.5	Carefully operation the tool magazine adjustment mode
1254	A006.6	Do not cycle start the tool magazine adjustment mode

PLC alarm No.	Add. A	Alarm content
1255	A006.7	Fail to return to the origin position for the tool clamping
1256	A007.0	Fail to return to the tool-change position for the tool clamping
1257	A007.1	Fail to return to the tool-change position for the spindle absence positioning
1258	A007.2	Fail to return to the tool-change position for the tool magazine abnormality
1260	A007.4	Do not cycle start the manual return tool-change position state
1261	A007.5	Fail to retract due to out of the origin
1262	A007.6	Exceed the safety position
1264	A008.0	Abnormal spindle velocity position mode conversion
1265	A008.1	Abnormal spindle position velocity mode conversion
1267	A008.3	Abnormal tool magazine forward/backward detection
1268	A008.4	Abnormal spindle releasing/clamping detection
1269	A008.5	Abnormal spindle orientation time-sequence detection
1270	A008.6	Do not perform the tool-change when Z axis is not returned to the mechanical zero
1271	A008.7	Enforce to stop the rotation when the tool magazine abnormality
1272	A009.0	Spindle tool number detection abnormality
1273	A009.1	Fail to forward when current cutter head and tool number are with the cutters
1274	A009.2	Fail to forward the tool magazine due to the cutter head does not perform the in-position
1288	A011.0	Index worktable releasing/clamping detection is overtime
1289	A011.1	Abnormal index worktable releasing/releasing detection
1290	A011.2	Fail to use the index worktable clamping equipment
1291	A011.3	Fail to rotate the index worktable due to it is clamping
1292	A011.4	Fail to move the index worktable due to it is releasing
1293	A011.5	Do not cycle start the safety door due to it is open
1294	A011.6	Do not change the gear during rigid tapping, it is better firstly cancel the rigid tapping and then change the gear.
1360	A020.0	Low lubrication pressure or grease level

The alarms between the A0.0~A19.7 are the red interruption alarm for the system. The system stops after alarms. A20.0~A31.7 are the self-defined yellow prompt alarm by the user; the system continues to operate after the alarm occurs. Normally, the system can be operated as usual.

The details of PLC alarm diagnosis information:

Alarm information: 1200 Abnormal air pressure detection (A000.0)

Fault reason:

Troubleshooting: Detect the state of the X002.0

Alarm information: 1201 Abnormal lubricant detection (A000.1)

Fault reason: User self-defined

Troubleshooting:

Alarm information: 1202 Abnormal lubrication motor detection (A000.2)

Fault reason: User self-defined

Troubleshooting:

Alarm information: 1203 Abnormal cooling motor detection (A000.3)

Fault reason: User self-defined

Troubleshooting:

Alarm information: 1204 Abnormal chip-removal motor detection (A000.4)

Fault reason: User self-defined

Troubleshooting:

Alarm information: 1205 Abnormal pressure grease pump motor detection (A000.5)

Fault reason: User self-defined

Troubleshooting:

Alarm information: 1207 Abnormal machine tool illumination lamp detection

Fault reason: User self-defined

Troubleshooting:

Alarm information: Abnormal machine controllable cabinet temperature detection (A001.0)

Fault reason: User self-defined

Troubleshooting:

Alarm information: 1209 Abnormal machine body temperature detection

Fault reason: User self-defined

Troubleshooting:

Alarm information: 1210 Abnormal machine vibration frequency detection (A001.2)

Fault reason: User self-defined

Troubleshooting:

Alarm information: 1211 Abnormal pressure grease temperature detection

Fault reason: User self-defined

Troubleshooting:

Alarm information: 1212 Excessive low of the pressure grease

Fault reason: User self-defined

Troubleshooting:

Alarm information: 1213 Fail to ready for the machine tool (A001.5)

Fault reason: User self-defined

Troubleshooting:

Alarm information: 1214 Spindle shifting abnormal, fail to rotate (A001.6)

Fault reason: The spindle gear abnormality is detected when the spindle is performed rotation code.

Troubleshooting: The gear I in-position detection switch (X4.1) does not close within the setting time of the T0021 when the spindle changes the gear I (that is, Y3.4=1); adjust the time of the T0021 or check whether the X4.1 is closed. The gear I in-position detection switch (X4.2) does not close within the setting time of the T0022 when the spindle changes the gear II (that is, Y3.5=1); adjust the time of the T0022 or check whether the X4.2 is closed. The gear I in-position detection switch (X4.3) does not close within the setting time of the T0023 when the spindle is placed at the gear III (that is, Y3.6=1); adjust the time of the T0023 or check whether the X4.3 is closed.

Alarm information: 1215 Firstly perform T code before executing the M06 code (A001.7)

Fault reason: Fail to execute the enabled T code when perform M06 code.

Troubleshooting: Execute the M06 code after perform the enabled T code.

Alarm information: 1216 Cutter releasing, fail to rotate the spindle (A002.0)

Fault reason: The spindle rotation code is performed when tool is on the releasing state, for example: M03, M04 and M19 will cause the spindle rotation by pressing the spindle positive, negative, JOG, positioning or AUTO state in the manual mode.

Troubleshooting: Press the "Clamping/Releasing" button in the manual state, so that it is on the clamping state (that is: Y0.2=0); check whether the state of the cutter clamping detection switch (X2.6) is set to 1. This alarm will not occur when rotating the spindle in the state of 1.

Alarm information: 1217 Fail to release the tool when spindle rotation (A002.1)

Fault reason: Tool releasing code is performed when spindle is on the rotation state.

Troubleshooting: Performing the tool releasing code can be avoided this alarm when the spindle is on the stop state.

Alarm information: 1218 Tool magazine abnormal stop, confirm the tool number again (A002.2)

Fault reason: The alarm occurs or press the “Reset” button when executing the M06 code and tool magazine is being rotated, and therefore this alarm will be then generated.

Troubleshooting: 1. Tool magazine returns zero again.

2. Reset the tool numbers of the spindle and tool magazine.

(Refer to the details operation: Section Three The Usage and Maintenance of the GSK218MC Series with Cone Tool-magazine)

Alarm information: 1219 Fail to rotate the spindle for the tool magazine infeed position (A002.3)

Fault reason: Tool does not the retraction in-position, perform the operation of the spindle rotation.

Troubleshooting: Return to the tool magazine to the retraction position (The X5.2 state can be detected and check whether the tool magazine is on the retraction position).

Alarm information: 1220 Abnormal spindle tool clamping detection (A002.4)

Fault reason: Tool magazine clamping detection switch (X2.6) does not close within the setting time of the T010 when executing the tool clamping motion (that is: Y0.2=0).

Troubleshooting: 1. Check whether the tool magazine clamping switch is normal.

2. Check whether the Y0.2 is output.

3. Readjust the time of the T010

Alarm information: 1221 Abnormal spindle tool releasing detection

Fault reason: Tool magazine releasing detection switch (X2.5) does not close within the setting time of the T009 when performing the tool releasing motion (that is: Y0.2=1).

Troubleshooting: 1. Check whether the tool releasing detection switch is normal

2. Check whether the Y0.2 is output

3. Readjust the time of the T009

Alarm information: 1222 Abnormal spindle unit temperature detection (A002.6)

Fault reason: User self-defined

Troubleshooting:

Alarm information: 1223 Spindle velocity detection abnormality (A002.7)

Fault reason: User self-defined

Troubleshooting:

Alarm information: 1224 Abnormal spindle motor enabling detection (A003.0)

Fault reason: User self-defined

Troubleshooting: Without

Alarm information: 1225 Abnormal spindle orientation in-position detection (A003.1)

Fault reason: The spindle positioning detection switch (X7.1) does not cut off within the setting time of the T013 when it is performed the positioning motion (that is: Y2.1=1).

Troubleshooting: 1. Spindle drive unit or spindle encoder abnormality

2. Check whether the Y6.3 is output
3. Readjust the time of the T013.

Alarm information: 1226 Spindle gear abnormality (A003.2)

Fault reason: Check the abnormality of the spindle gear

Troubleshooting: The gear I in-position detection switch (X4.1) does not close within the setting time of the T0021 when the spindle changes the gear I (that is: Y3.4=1); and adjust the time of the T0021 or check whether X4.1 is closed. The gear I in-position detection switch (X4.2) does not close within the setting time of the T0022 when the spindle changes the gear II (that is: Y3.5=1); and adjust the time of the T0022 or check whether X4.2 is closed. The gear I in-position detection switch (X4.3) does not close within the setting time of the T0023 when the spindles the gear III (Y3.6=1); and adjust the time of the T0023 or check whether X4.3 is closed.

Alarm information: 1227 Fail to rotate the tool magazine because it is not at the origin (A003.3)

Fault reason: Tool magazine does not at the retraction position and the Z axis is not at the origin, an alarm may generate pressing the "Tool magazine positive" or "Tool magazine negative" button in the manual state.

Troubleshooting: Return the tool magazine to the retraction position or the Z axis returns to the origin position

Alarm information: 1228 Fail to cycle start when tool magazine in the infeed position (A003.4)

Fault reason: Tool magazine does not at the retraction position, an alarm may generate by pressing the "Start" button in the Auto, MDI or DNC mode.

Troubleshooting: Return the tool magazine to the retraction position.

Alarm information: 1229 Set the spindle tool number (A003.5)

Fault reason: When the spindle tool number is set to "0", an alarm may generate by pressing the "Clamping/releasing" button.

Troubleshooting: This alarm only prompts that when spindle tool number is set as 0, the tool can not be installed on the spindle, which can be shielded this alarm by modifying the K0.11.0.

Alarm information: 1230 Fail to perform the tool-change when spindle tool is on the releasing state.
(A003.6)

Fault reason: M06 or M50 code is performed when spindle tool is on the releasing state (Y0.2=1).

Troubleshooting: Put the spindle tool is on the clamping state (Y0.2=0)

Alarm information: 1231 Fail to perform the tool-change when the tool magazine does not at the retraction position (A003.7).

Fault reason: M06 or M50 is performed when tool magazine is not at the retraction position.

Troubleshooting: Put the tool magazine is on the retraction position

Alarm information: 1232 Abnormal tool magazine rotation in-position detection (A004.0)

Fault reason: User self-defined

Troubleshooting:

Alarm information: Abnormal tool magazine rotation motor detection (A004.1)

Fault reason: User self-defined

Troubleshooting:

Alarm information: 1234 Program stops operation at the tool magazine infeed position (A004.2)

Fault reason: The alarm occurs when tool magazine does not at the retraction position when the program is being operated.

Troubleshooting: Put the tool magazine at the retraction position and then perform the program again.

Alarm information: 1235 Abnormal tool magazine movement in-position detection (A004.3)

Fault reason: User self-defined

Troubleshooting:

Alarm information: 1236 Abnormal tool magazine zero return detection (A004.4)

Fault reason: User self-defined

Troubleshooting:

Alarm information: 1237 Tool magazine origin position lost, return to zero again (A004.5)

Fault reason: This alarm occurs when the zero return abnormality stop when the tool magazine is performed the zero return.

Troubleshooting: Tool magazine returns to the zero position again.

(Refer to the details operation: Section Three The Usage and Maintenance of the GSK218MC Series with Cone Tool-magazine)

Alarm information: 1238 Abnormal infeed in-position detection (A004.6)

Fault reason: User self-defined

Troubleshooting:

Alarm information: 1239 Abnormal retraction in-position detection (A004.7)

Fault reason: User self-defined

Troubleshooting:

Alarm information: 1240 Tool magazine abnormality, zero return again (A005.0)

Fault reason: 1. Detect the tool-magazine counting switch (X5.3) abnormality so that pulse signal occurs when tool magazine stops the rotation setting time of the T102.

2. Detecting the tool magazine counting switch is 0 or 1 which exceeds the setting time of the T103 when the tool magazine rotates.

Troubleshooting: 1. The output section (Y3.0 and Y3.1) are abnormal when tool magazine is positive or negative.

2. Tool magazine counting switch abnormality.
3. Reset the values of T102 and T103.

(Refer to the details operation: Section Three The Usage and Maintenance of the GSK218MC Series with Cone Tool-magazine)

Alarm information: 1241 Abnormal tool magazine infeed detection (A005.1)

Fault reason: Tool magazine infeed detection switch (X5.1) does not operation within the setting time of the T104 when the tool magazine performs the infeed motion (that is: Y3.2=1)

Troubleshooting: 1. Check whether the tool magazine infeed detection switch.

2. Check whether the Y3.2 is output.
3. Readjust the time of the T104.

Alarm information: 1242 Abnormal tool magazine retraction detection (A005.2)

Fault reason: The tool magazine infeed detection switch (X5.2) does not operated within the setting time of the T105 when tool magazine performs the retraction motion (that is: Y3. 3=1).

Troubleshooting: 1. Check whether the tool magazine infeed detection switch is normal.

2. Check whether the Y3.3 is output.
3. Readjust the time of the T105.

Alarm information:1243 Enabled setting of the tool magazine zero return position (A005.3)

Fault reason: This alarm occurs when K010.6=1 in the case of the tool magazine is without the zero return switch (that is: K010.1=0), and then the tool magazine zero position is enabled.

Troubleshooting: Set the K010.6 to 0.

(Refer to the details operation: Section Three The Usage and Maintenance of the GSK218MC Series with Cone Tool-magazine)

Alarm information: 1244 Tool-change abnormally stops, ensure the tool magazine is normal (A005.4)

Fault reason: Tool magazine is being automatically performed the tool-change. Tool-change stops or it can not detect that the tool magazine is not at the retraction position when starting the system when the abnormality occurs, and then the alarm generates. This alarm is only prompted that the operator tool magazine and the tool number on the spindle may disorder. The tool magazine may still abnormal after cleaning this alarm, it is better to reset the tool magazine and the tool number on the spindle. (Refer to the details operation: Section Three The Usage and Maintenance of the GSK218MC Series with Cone Tool-magazine).

Troubleshooting: 1. Immediately clear this alarm by “Reset” button.

2. Readjust the tool magazine and confirm the tool number on the spindle is consistent, which includes the tool magazine returning to the retraction position, spindle on the clamping state, as well, the current tool case is consistent with the current value of the CTR100, the tool number on the spindle is consistent with the D245 and ensure that there is no tool on the spindle when the value of the D245 is set to 0.

Alarm information: 1245 There is code tool number in the tool table or code tool number repeated (A005.5)

Fault reason: There is no specified tool number from the T code in tool table (D001-D099) or the tool number specified from T code is repeated in the tool table.

Troubleshooting: Modify the tool number value in the tool table.

Alarm information: 1246 Fail to perform the infeed because it is not in the tool-change position (A005.6)

Fault reason: Tool magazine infeed motion is performed when Z axis is not at the tool-change position.

Troubleshooting: Perform the G91 G30 Z0 code so that the Z axis returns to the tool-change position.

Alarm information: 1247 Tool magazine can not perform the infeed because the spindle is under

positioning (A005.7)

Fault reason: There is no positioning for the spindle, perform the operation of the tool magazine infeed.

Troubleshooting: Perform the spindle positioning.

Alarm information: 1248 Tool magazine can not be retracted in the tool releasing state (A006.0)

Fault reason: Perform the tool retraction operation in the state of the spindle tool releasing.

Troubleshooting: Clamp the spindle tool and then retract it.

Alarm information: 1249 Spindle is with cutter instead if infeed (A006.1)

Fault reason: Z axis is at the origin, and there is cutter (D245 is not set to 0) on the spindle, the tool magazine infeed operation is then performed.

Troubleshooting: Disassemble the cutter on the spindle, set the D245 to 0.

Alarm information: 1250 Fail to infeed because the current tool number between the spindle and tool magazine is different. (A006.2)

Fault reason: Z axis is at the tool-change position, the tool number on the spindle is different from the one on the current tool case; the tool magazine infeed operation is executed.

Troubleshooting: Rotate the tool magazine so that the tool number on the current tool case is identical with the one on the spindle.

Alarm information: 1251 Turn off the power (A006.3)

Fault reason: That the parameter can be enabled after the system is restarted again is altered.

Troubleshooting: Restart the system.

Alarm information: 1252 Clamp the tool, do not move the Z axis (A006.4)

Fault reason: When the tool magazine is on the infeed position, and the spindle tool is on the clamping state, the Z axis movement is then performed.

Troubleshooting: 1. Put the tool magazine is on the retraction position
2. Make the spindle tool is on the releasing state.

Alarm information: 1253 Carefully operate the tool magazine adjustment mode (A006.5)

Fault reason: This alarm occurs when K010.7 is set to 1, in this case, only prompts that the tool magazine enters the debugging mode; it is necessary to carefully operate it because the alarm and interlocking signal related with the tool magazine is fully released; otherwise, the abnormality may occur, as well the machine may be damaged.

Troubleshooting: Clear this alarm by "Reset" button (Note: Clear this alarm means not that the system is not on the tool magazine debugging mode. It is necessary to set the

K010.7 as 0 after retreating from the tool magazine debugging mode).

Alarm information: 1254 Do not cycle start in the tool magazine debugging mode (A006.6)

Fault reason: When the value of the K010.7 is set to 1, this alarm occurs by pressing the “Start” button in the Auto, MDI or DNC mode.

Troubleshooting: Set the K010.7 to 0.

Alarm information: 1255 Tool clamping can not return to the origin (A006.7)

Fault reason: When the tool magazine is at the infeed position, and the spindle tool is on the clamping state, perform the operation of the Z axis origin return.

Troubleshooting: 1. Make the tool magazine on the retraction position
2. Make the spindle tool is on the releasing state.

Alarm information: 1256 Tool clamping can not return to the tool-change position (A007.0)

Fault reason: When the tool magazine is at the infeed position, and the spindle tool is on the clamping state, perform the operation of the Z axis tool-change return.

Troubleshooting: 1. Make the tool magazine is at the retraction position.
2. Make the spindle tool is on the releasing state.

Alarm information: 1257 Spindle can not return to the tool-change position because it is under positioning (A007.1)

Fault reason: When the tool magazine is at the infeed position, and the spindle does not position, perform the operation of the Z axis tool-change return.

Troubleshooting: 1. Make the tool magazine is at the retraction position
2. Spindle positioning

Alarm information: 1258 Fail to return to the tool-change position because the tool magazine is abnormal (A007.2)

Fault reason: User self-defined

Troubleshooting:

Alarm information: 1260 Do not perform the cycle start in the manual tool-change position return state (A007.4)

Fault reason: When K011.1=1 (When the manual tool-change position return operation is enabled), this alarm will be generated pressing the “Start” button in the Auto, MDI and DNC mode.

Troubleshooting: Set the K011.1 to 0.

Alarm information: 1261 Fail to retract due to out of the origin (A007.5)

Fault reason: When the tool magazine is at the infeed position, and the Z axis is not at the origin, perform the operation of the tool magazine retraction.

Troubleshooting: Make the Z axis returning to the origin and then retract the tool.

Alarm information: 1262 Exceed the safety position (A007.6)

Fault reason: Tool is at the infeed position, when moving the Z axis, which exceeds the tool-change position.

Troubleshooting: Make the Z axis coordinate is placed at between the tool-change position and origin by moving the Z axis.

Alarm information: 1264 Abnormal spindle position mode conversion (A008.0)

Fault reason: Fail to receive the spindle position mode completion signal within the setting time of the T24 when executing the M29 code.

Troubleshooting: Adjust the setting time by T24 or check whether the spindle position mode completion signal is output.

Alarm information: 1265 Abnormal spindle velocity mode conversion (A008.1)

Fault reason: Fail to receive the spindle velocity mode completion signal within the setting time of the T28 when executing the M 28 code.

Troubleshooting: Adjust the setting time by T28 or check whether the spindle position mode completion signal is output.

Alarm information: 1267 Abnormal tool magazine forward/backward detection (A008.3)

Fault reason: System detects the tool magazine forward in-position signal and tool magazine retraction in-position signal at the same time.

Troubleshooting: Detect whether the signals both X5.1 and X5.2 are normal, and whether the type selection of the switch is correct.

Alarm information: 1268 Abnormal spindle releasing/clamping detection (A008.4)

Fault reason: System detects the tool releasing signal and tool clamping signal at the same time.

Troubleshooting: Detect whether the signals both X2.5 and X2.6 are normal, and whether the type selection of the switch is correct.

Alarm information: 1269 Abnormal spindle orientation time-sequence detection (A008.5)

Fault reason: System has been detected the spindle orientation completion signal before the spindle orientation operation.

Troubleshooting: Detect whether the signal X7.1 is normal, and whether the type selection of the switch is correct.

Alarm information: 1270 Do not perform the tool-change when Z axis is not returned to the mechanical zero (A008.6)

Fault reason: The system performs the M06 or M50 code without executing the Z axis mechanical zero return operation after it is power on or ESP.

Troubleshooting: Firstly perform the Z axis zero return operation, and then perform the tool-change

operation.

Alarm information: 1271 Enforce to stop the rotation when the tool magazine abnormality (A008.7)

Fault reason: 1. The pulse signal generated from the tool magazine counting switch (X5.3) does not detect within the T109 setting time after tool magazine delivers the rotation command.

2. The state in the tool magazine counting switch 0 or 1 is detected and exceeds the setting time of the T103 when the tool magazine rotates.

Troubleshooting: 1. Abnormal tool magazine positive or negative output section (Y3.0 and Y3.1).

2. Abnormal tool magazine counting switch.

3. Reset the values of the T109 and T103.

(Refer to the details operation: Section Three The Usage and Maintenance of the GSK218MC Series with Cone Tool-magazine)

Alarm information: 1272 Abnormal spindle tool number detection (A009.0)

Fault reason: When the tool detection equipment is installed on spindle and K12.0 is set to 1, the spindle is at the releasing/clamping state and the spindle tool number is 0, but the system detects that the spindle is with a tool, and then perform the M06 or M50 code.

Troubleshooting: Check whether the signal of the X2.7 is normal, disassemble the tool from the spindle, and then perform the M06 tool-change code.

Alarm information: 1273 Fail to forward because the current cutter head number is with tool (A009.1)

Fault reason: When the tool detection equipment is installed on tool magazine and K12.0 is set to 1. There is a tool on spindle, the system detects that the tool on the tool magazine when performing the tool magazine forward.

Troubleshooting: 1. Check whether the signal of X5.5 is normal.

2. Readjust the tool magazine and confirm whether the tool number on the spindle is consistent, which includes the tool magazine retraction position return, spindle on the tool-clamping state, whether the current tool case number is consistent with the current value of CTR100, whether the tool number on the spindle is consistent with the value of the D245 and ensure that there is no tool on the spindle when the value of D245 is set to 0. If they are inconsistent, it is better perform the tool magazine zero return operation.

(Refer to the details operation: Section Three The Usage and Maintenance of the GSK218MC Series with Cone Tool-magazine)

Alarm information: 1274 Fail to forward the tool magazine because the cutter head is not in-position (A009.2)

Fault reason:

Troubleshooting:

Alarm information: 1288 Index worktable releasing/clamping detection overtime (A011.0)

Fault reason: Fail to receive the detection signal within the delay time.

Troubleshooting: Check the signal circuit and ensure the releasing/clamping signal input is normal.

Alarm information: 1289 Index worktable releasing/clamping detection abnormality (A011.1)

Fault reason: Input the releasing/clamping signal at the same time.

Troubleshooting: Check the signal circuit and ensure the releasing/clamping signal input is normal.

Alarm information: 1290 Fail to use the index worktable clamping equipment (A011.2)

Fault reason: When the index worktable clamping equipment does not use (that is, K12.4=0), the index worktable releasing or clamping motion command is performed.

Troubleshooting: Perform the index worktable releasing or clamping motion command after the K12.4 is set to 1.

Alarm information: 1291 Fail to rotate because the index worktable does not release (A011.3)

Fault reason: The index worktable rotation is performed when it is on releasing state.

Troubleshooting: Perform the index worktable rotation after it is clamped; or adjust the index worktable to the debugging mode (that is, K12.6 is set to 1), and then perform the index worktable rotation operation.

Alarm information: 1292 Fail to move because the index worktable does not clamp (A011.4)

Fault reason: When the index worktable is on releasing state, the feed axis is then performed the movement operation.

Troubleshooting: Perform the feed axis movement operation after the index worktable is clamped; or adjust the index worktable to the debugging mode (that is, K12.6 is set to 1), and then the feed axis is performed the movement operation.

Alarm information: 1293 Do not cycle start because the safety door opens (A011.5)

Fault reason: The cycle start button is controlled in the case of the safety door does not close when the safety door detection equipment is used (that is, K8.3=1).

Troubleshooting: Perform the cycle start after closing the safety door.

Alarm information: 1294 Fail to shift in the rigid tapping, firstly cancel the rigid tapping and then shift (A011.6)

Fault reason: Use the spindle shift equipment; do not perform M29 tapping command when the shifting is not in-position.

Troubleshooting: Firstly cancel the rigid tapping and then perform the shift.

Alarm information: 1360 Low lubrication pressure or grease level (A020.0)

Fault reason:

Troubleshooting: Detect the state of X001.7

Precaution:

The alarm of the “User self-defined” in the fault reason does not design in the ladder diagram, user should add it by altering the ladder diagram.

Table 5 The definition of the TMR parameter

Add.	Note	Initial value (ms)	User setting value (ms)
T001	Spindle positive completion delayer	500	
T002	Spindle negative completion delayer	500	
T003	Spindle shift completion delay time	500	
T004	Spindle positioning completion delayer	0	
T005	Miscellaneous function completion delayer	0	
T006	Spindle shift delayer	500	
T007	Spindle tool releasing completion delayer	500	
T008	Spindle tool clamping completion delayer	500	
T009	Spindle tool releasing in-position detection time	8000	
T010	Spindle tool clamping in-position detection time	8000	
T011	Pulse signal 1 time for 1 second	50	
T012	Pulse signal 2 time for 1 second	50	
T013	Spindle positioning detection time setting	8000	
T014	Spindle positive detection time setting	500	
T015	Spindle negative detection time setting	500	
T016	Lubrication OFF time setting (Unit: minute)	30	
T017	Lubrication ON time setting (Unit: second)	10	
T018	Spindle positioning delay detection time setting	2000	
T019	Spindle JOG delayer	500	
T020	Program restart delayer	10	
T021	Spindle gear I delay detector	10000	
T022	Spindle gear II delay detector	10000	
T023	Spindle gear III delay detector	10000	
T024	Spindle velocity position mode conversion detection time	10000	
T025	M29 execution completion time (It is enabled without detection signal)	4000	
T026	The positioning completion time in the spindle position mode (It is enabled without the detection signal)	2000	
T027	M28 execution completion time (It is enabled without detection signal)	2000	
T028	Spindle position velocity mode conversion detection time	10000	
T029	Spindle brake time	1000	
T030	The shift delay time when the spindle gear 1 is without the detection switch	3000	

Add.	Note	Initial value (ms)	User setting value (ms)
T031	The shift delay time when the spindle gear 2 is without the detection switch	3000	
T032	The shift delay time when the spindle gear 3 is without the detection switch	3000	
T033	The gear cancels the delay completion time when spindle gear control is without detection switch	3000	
T034	M5 completion delay time	500	
T035	Spindle shift completion delay OFF	800	
T036	Index worktable releasing completion delay	500	
T037	Index worktable clamping completion delay	500	
T038	Index worktable releasing delay detection	5000	
T039	Index worktable clamping delay detection	5000	
T100	Manual rotation delay time 1 for the cone tool magazine	2000	
T101	Manual rotation delay time 2 for the cone tool magazine	2000	
T102	Delay detection time setting stop for the cone tool magazine	2000	
T103	Rotation delay detection time setting for the cone tool magazine	3000	
T104	Infeed delay detection time setting for the cone tool magazine	5000	
T105	Retraction delay detection time setting for the cone tool magazine	5000	
T106	Infeed completion delayer for the cone tool magazine	0	
T107	Retraction completion delayer for the cone tool magazine	0	
T108	Rotation delay detection time setting 2 for the cone tool magazine	3000	
T109	Enforcement stop time setting for the abnormal tool magazine rotation	5000	

Table 6 The definition of the DATA parameter

Definition	Note	User setting value
D000	Spindle tool number display	Fail to set
D001	The No.1 tool number	
D002	The No.2 tool number	
⋮	⋮	

D098	The No.98 tool number	
D099	The No.99 tool number	
D100	Tool magazine capacity	
D241	T code tool number	Fail to set
D243	Current tool case number	Fail to set
D245	Spindle tool number	

Precautions:

1. The setting value of the D100 should be less than 100, which should be same with the one of the CTR100; otherwise the abnormality may occur.
For example: When D100=16, D001-D016 in the data table are enabled.
 When D100=24, D001-D024 in the data table are enabled.
2. D000 only displays the spindle tool number, and the spindle tool number can not be modified in the D000, it is better to alter it at the D245 when the spindle tool number should be altered.
3. The value of the D241 can not be modified.
4. D240~D247 are used by system, so user can not self-defined.
5. Refer to the Section three for details.

Table 7 The definition of the CTR parameter

Add.	Note	Initial value	User setting value
C100	Tool magazine capacity setting	16	

Precaution:

1. The setting value of the CTR 100 should be less than 100, which should be same with the one of the D100; otherwise the abnormality may occur.
 For example: CTR100=16, the tool case number of the tool magazine is 16.
 CTR100=24, the tool case number of the tool magazine is 24.

Table 8 The definition of the M code

M code	F signal	Function	Remark
M00	F031.7	Program stop	
M01	F030.4	Selection stop	
M02	F030.5	Program end	
M03	F030.0	Spindle positive	
M04	F030.1	Spindle negative	
M05	F030.2	Spindle stop	
M06	F030.3	Automatic tool-change	
M08	F031.0	Coolant ON	
M09	F031.1	Coolant OFF	

M code	F signal	Function	Remark
M10	F031.2	A axis clamping	
M11	F031.3	A axis releasing	
M16	F026.0	Spindle releasing command	
M17	F026.1	Spindle clamping command	
M18	F028.3	Cancel the spindle exact stop	
M19	F026.2	Spindle exact stop command	
M20	F032.5	Spindle neutral position command	
M21	F026.3	Tool-homing command in tool-return	
M22	F026.4	Tool-homing command in capturing the new tool	
M26	F027.5	Start the chip-removal valve	
M27	F027.6	Close the chip-removal valve	
M28	F032.3	Cancel the rigid tapping	
M29	F032.2	Rigid tapping command	
M30	F028.0	Program end	
M35	F028.1	Start the chip-removal promotion transmitter	
M36	F028.2	Close the chip-removal promotion transmitter	
M44	F026.7	Spindle blowing start	
M45	F027.0	Spindle blowing stop	
M50	F027.1	Automatic tool-change start	
M51	F027.2	Automatic tool-change end	
M53	F027.3	Judge whether the tool is correct after the tool-change is performed	Reserved
M55	F027.4	Judge whether the spindle is with the tool.	Reserved

Precautions:

1. The M codes marked with "F*** **" in the F signal column and with "Reserved" in the remark can be used.
2. M16 M17 M21 M22 M23 M24 are only enabled in the tool-change, which can not be used alone.

III. The Usage and Maintenance of the Cone Tool Magazine**1. Tool magazine installation and the relative PLC parameter setting**

Operation purpose: The ladder diagram is suitable for the configuration of the tool magazine.

A. Requirements for machine tool when the ladder diagram equips with the cone tool magazine:

1. The spindle tool automatic clamping/releasing equipment on the machine tool is installed the NORM in-position detection switch.
2. There is positioning function on spindle, and its positioning angle can be adjusted.
3. The capacity of the tool magazine is less than 100.
4. Tool magazine can be performed the positive or negative.

5. The tool magazine is with the counting switch, forward in-position detection switch and backward in-position detection switch.
6. Tool magazine with zero return switch (Optional)

B. The circuit connection related with the tool magazine:

1) Input section

Add.	Note	Remark
X002.2	Index worktable releasing detection	NORM contactor
X002.3	Index worktable clamping detection	NORM contactor
X002.4	External clamping/releasing control	Optional
X002.5	Releasing detection	NORM contactor
X002.6	Clamping detection	NORM contactor
X005.1	Tool magazine forward in-position	NORM or NC
X005.2	Tool magazine backward in-position	NORM or NC
X005.3	Tool magazine counting switch	NORM or NC
X005.4	Tool magazine zero return switch	Optional
X005.5	Current cutter head tool detection switch	Optional
X007.1	Spindle orientation in-position	NC contactor

2) Output Section

Add.	Note	Remark
Y000.2	Tool releasing/clamping	
Y001.6	Index worktable releasing	
Y001.7	Index worktable clamping	
	Tool magazine positive	
Y003.0	Tool magazine positive	
Y003.1	Tool magazine negative	
Y003.2	Tool magazine forward	
Y003.3	Tool magazine backward	
Y006.2	Spindle enabling	
Y006.3	Spindle orientation	

C. The selection of the tool magazine switch type

Add.	Definition	State 0	State 1
K010.1	Whether the tool magazine is with the zero return switch	Without	With
K010.2	Whether the tool magazine zero return switch is selected the NC type	NORM	NC
K010.3	Whether the tool magazine infeed switch is selected the NC type	NORM	NC
K010.4	Whether the tool magazine retraction switch is selected the NC type	NORM	NC

Add.	Definition	State 0	State 1
K010.5	Whether the tool magazine counting switch is selected the NC type	NORM	NC

For example: There is one tool magazine is without zero return switch, other detection switches are NORM, and its corresponding parameters are set as: K010.1=0 K010.2=0 K010.3=0 K010.4=0 K010.5=0.

D. The setting of the tool magazine capacity

Input the tool magazine capacity in the DATA100 and CTR100.

Precautions:

1. Tool magazine capacity is the tool case numbers in the tool magazine.
2. The setting value both DATA100 and CTR100 should be less than 100.

For example: When the tool magazine capacity is 16, set the DATA100 to 16, CTR100 to 16.

E. The setting of tool number in the tool magazine:

D001--D099 in the data table are separately corresponding to the No.1—No.99 tool case in the tool magazine, and the setting in the D001--D099 data table are separately corresponding to the tool number No.1-No.99 of the tool case in the tool magazine, D245 is the tool number on the spindle.

Precautions:

1. Same tool number (other than 0) in the D001--D099 can not be set, otherwise, the system alarms when performing the tool-change.
2. The setting range of the tool number should be available for the setting requirement of the data parameter 0206; otherwise, the system alarms when performing the T code.

For example: When the tool magazine capacity is 16:

If set the 1—16 as the D1—D16 in turn, when performing the T8 M6, the No.8 tool case will perform the tool change after rotating to the tool-change position;

If set the 0, 20, 30.....160 as the D1—D16 in turn, when performing the T8 M6, the No.8 tool case will perform the tool change after rotating to the tool-change position;

If both the D1 and D2 are set to 8, the system may alarm when performing the T8 M6.

F. The time parameter (TMR) setting related with the tool magazine

Add.	Note	Setting range	Initial value (ms)
T004	Spindle positioning completion delayer	Greater than or equal to 0	0

Add.	Note	Setting range	Initial value (ms)
T007	Spindle tool releasing completion delayer	Greater than or equal to 0	0
T008	Spindle tool clamping completion delayer	Greater than or equal to 0	0
T009	Spindle tool releasing detection time setting	Greater than the releasing time	8000
T010	Spindle tool clamping detection time setting	Greater than the clamping time	8000
T013	Spindle positioning detection time setting	Greater than the positioning time	8000
T018	Spindle positioning delay detection time setting	It is related with the positioning width	2000
T036	Index worktable releasing completion delay	Greater than or equal to 0	500
T037	Index worktable clamping completion delay	Greater than or equal to 0	500
T038	Index worktable releasing delay detection	Greater than or equal to 0	5000
T039	Index worktable clamping delay detection	Greater than or equal to 0	5000
T040	Index worktable releasing delay completion	Greater than or equal to 0	4000
T041	Index worktable clamping delay completion	Greater than or equal to 0	4000
T100	Manual rotation delay 1 of cone tool magazine	Greater than a tool position rotation time	2000
T101	Manual rotation delay 2 of cone tool magazine	Greater than a tool position rotation time	2000
T102	Stop the delay detection time of cone tool magazine	Greater than a tool position rotation time	2000
T103	Rotate the delay detection time of cone tool magazine	Greater than a tool position rotation time	3000
T104	Tool infeed delay detection time of cone tool magazine	Greater than the tool infeed time	5000
T105	Tool retraction delay detection time of cone tool magazine	Greater than the tool retraction time	5000
T106	Tool infeed completion delayer of cone tool magazine	Greater than or equal to 0	0
T107	Tool retraction completion delayer of cone tool magazine	Greater than or equal to 0	0
T108	Rotation delay detection time setting 2 of cone tool magazine	Greater than a tool position rotation time	3000
T109	Enforce to stop the time setting because the tool magazine abnormality	Greater than a tool position rotation time	5000

Precautions:

1. The above-mentioned parameters (TMR) are related with the performances, such as the type and the rotation velocity of the tool magazine.
2. If the above-mentioned parameters (TMR) are set incorrect, the alarm may occur and the tool-change can not be normally performed.

The ladder diagram is coincident with the configuration of the tool magazine based upon the basis operation from A to F steps; however, the tool magazine can not be normally operated. The tool magazine only can be positive, negative, infeed and retraction by the setting and operation on the Section Two, so that check each step of the tool magazine is normal.

2. The manual and zero return operation of the tool magazine

Operation purpose: Check each step of the tool magazine is normal.

The detailed operation steps are shown below:

A. Tool magazine usage enabled.

1. User the Ladder01.grp ladder diagram in the system default state, that is, the cone tool magazine ladder diagram. Bit parameter NO: 53 #0=1, NO: 53 #1=0, NO: 53 #2=0 and NO: 53 #3=0.
2. The KPAR parameter K001.0 of the PLC is set to 1.

B. Confirm the tool rotation direction:



In the manual mode, press the  button, the tool magazine rotates following with the



addition of the tool number; press the , the tool magazine rotates following with the decrease of the tool number; otherwise, the tool magazine counting may disorder, so that tool-change is incorrect. Solve this problem by adjusting the tool magazine and rotating the motor's phase-sequence.

C. The zero return operations of the tool magazine:



The zero return operation of the tool magazine can be divided into: with zero return switch and without the zero return switch.



1. Tool magazine with the zero return switch: Press the  in the "Mechanical zero return", the zero return is completed (the indicator flashes means that the tool magazine is being performed the zero return) when "Tool magazine zero return indicator" ON.

2. When the tool magazine is without zero return switch, set the tool magazine zero point based upon the following steps:



a. In the manual mode, press the  or , so that the tool magazine No.1 tool case rotates to the tool-change position.

b. In the MDI mode, set the K010.6 to 1.



c. In the mechanical zero return mode, press then  till to the “Tool magazine zero return indicator” ON.

d. Set the K010.6 to 0.

3. The adjust of the spindle positioning angle and tool-change coordinate position

A. The adjust of the spindle positioning angle (Refer to the User Manual for the Spindle Drive Unit)

The adjust steps of the spindle positioning angle (Examples):





1) Input the system debugging password. Press the , then enter the “Set (Password)” interface by [Password] soft-key. In the MDI mode, input the system debugging password, and then



press the . The “password correct” shows at the left corner.



2) Press the  key on MDI keyboard, press [KPAR] software in the  interface, and then enter the viewing and setting interface of the non-volatile relay. Position the cursor to the K010.7 (Whether the tool magazine enters the adjust mode) by the four direction buttons on the

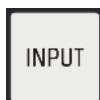

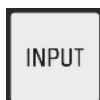
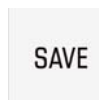
keyboard; press the number “1”, then , and then the , the data column prompts: “KPAR download successful!”, it means the storage is executed, and the tool magazine adjust mode is then enabled (The tool magazine can perform the forward or backward freely). In this case, the system alarm: 1253 Carefully operate the tool magazine adjust mode, cancel this alarm by resetting button.

3) Prepare a tool handle, disassemble the nail.

4) Perform the Z axis zero return operation in the zero return mode.



5) In the system manual mode, press , so that the tool magazine is performed at the forward position.

6) Install the tool handle without nail on the tool magazine, and the adjust it.

7) In the system MPG mode, move the Z axis up and down (Carefully operate it!). in this case, directly revolve the motor's rotor or connect to the spindle on the motor's rotor, cycle it for more than one circle, and then adjust the spindle position by hand, till the key on the spindle enters the groove of the tool handle.

8) Set the positioning angle in the spindle drive. (Refer to the Appendix: The Setting Method of the DAP03 Positioning Angle for details.)

B. The adjustment of the tool-change coordinate position

1. Move the spindle to the safety position in the manual mode after the orientation adjustment is performed based upon the above-mentioned methods, then perform the spindle orientation, and then perform the tool releasing motion; install the nail on the tool handle (in this case, the tool magazine is still on the infeed position). Adjust the tool-change coordinate position (It is important to ensure that the tool is already on the releasing state) by moving the Z axis up and down in the system's MPG method. Lastly, record the adjusted machine coordinate of the Z axis (For example: -120.000).

2. Perform the tool clamping motion, so that the tool magazine returns to the tool-retraction



position (It is important to ensure that the tool is already on the clamping system) by

3. In the MDI mode, Set the K010.7 to 0 in terms of the above-mentioned methods.

4. The recorded Z axis machine coordinate before is set at the data parameter 0052, it is necessary to set this parameter correctly; otherwise, the unexpected hazard may occur to cause the machine damage.

The correct tool-change operation can be operated based upon the above-mentioned two steps. The operation descriptions for performing the T and M codes are shown below:

TxxM6; The execution effect is same as the Txx; M6;

T0M6; The tool on the spindle will not return to the tool magazine.

Notice: When the spindle tool number is treated as 0, do not install the tool on the spindle; otherwise, the unexpected accident may occur when tool-changing, it may be damaged the machine, too!



Attachment: The setting method of the DAP03 positioning angle

1) Turn on the power of the controllable equipment, LED default display: r 0;

2) Enter the monitoring mode by , then display: dP-SPd;

3) There are 25 display states of the monitoring method, select the desired state by  .

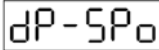

Find out the  (Here, when the motor and spindle encoders are regarded as the

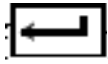
positioning encoder, then find out the );  then displays by



4) In this case, the motor is on the free state, directly revolve the motor's rotor or connect to the spindle of the motor's rotor; rotate the motor's rotor one cycle at least, the drive unit may automatically search the correct position of the motor's encoder; the monitoring display becomes  after finding the correct position.

5) After the motor rotates one circle at least, and then adjust the motor (spindle) rotor positioning position is at the positioning point. Stop the operation to observe the absolute position of the rotor. In this case, the monitoring displays . The numerical value will be saved in the parameter PA58, which is regarded as the positioning place.

Note: Suppose that the monitoring displays , mark "E" means that the motor's rotor is on the incorrect positioning place, and its value can not regarded as the positioning place reference value. Rotate the motor's rotor one cycle at least, the drive unit may automatically search the correct position of the motor's encoder; the monitoring display becomes  after finding the correct position.

4. The correct troubleshootings of the ESP, OFF & RESET and Alarm during tool magazine operation

1. When the tool-change specified in MDI mode or the tool-change method in the Auto mode, and when the tool magazine is at the forward limit position, the spindle falls to the tool-clamping position, and then clamp the tool; when the tool magazine will to retract but hold it, the machine tool should be used continuously if the ESP, OFF & Alarm, REST are generated. Retreat from the tool



magazine by the  on the system in the Manual mode, so that the tool can be departed from the current tool magazine position, and then use it (Notice: in this moment, do not release the spindle, retreat from the tool magazine by lifting up the Z axis, so that the tool magazine position of the current spindle is installed the tool; it will become the hidden trouble when performing the tool-change next time).

2. When the tool-change specified in MDI mode or the tool-change method in the Auto mode,

and when the tool magazine is at the forward limit position; the spindle has been released the tool, and Z axis will lift but hold it, or the Z axis does not rotate the cutter head yet after lifting, it should be used continuously if the ESP, OFF & Alarm, RSET are generated; Press the “Tool-releasing” button on the spindle in the Manual mode, so that the tool is on the releasing state, and then lift up the Z axis



in the Manual or MPG mode to the safety position; retreat from the tool magazine by  on the system. (Notice: The tool magazine position of the current spindle is installed with the tool, but there is no tool on the spindle, the system should be display “T0000”), and therefore, the system can be normally used.

3. When the tool-change specified in MDI mode or the tool-change method in the Auto mode, and when the tool magazine is at the forward limit position; the Z axis is already lifted at the 1st reference point; The current tool number may inconsistent with the actual one if the ESP, OFF & Alarm and RESET when the cutter head is being rotated. The system alarm occurs: “1218 Confirm the tool number again because the tool magazine abnormally stops” or “1244 Ensure the tool magazine is normal when tool-change abnormality stop” etc. If you want to use it continuously, retreat



from the tool magazine by the  on the system in the Manual mode; the system can be used normally after the tool magazine zero return again and after the spindle and tool magazine tool numbers are reset. (Refer to the Section Three The usage and maintenance with the cone tool magazine for the GSK218MC CNC system).

IV. The Macro Note Matching with the Cone Tool Magazine

O91001;	(Program name)
G65 H81 P50 Q#1003 R1;	(Miscellaneous lock, machine lock, rotate the N50 program to the end when spindle tool number =T code tool number)
G65 H81 P30 Q#1002 R1;	(Rotate the N30 instead of executing the tool-searching code when T code tool number=0)
G69 G50 G15 G80 G40;	(Cancel the relative modal)
M50;	(Tool-change begins, check whether the tool-change is suitable, if does not, the alarm may occur)
G65 H81 P20 Q#1000 R1;	(Spindle tool number=0 that is, without tool on the spindle, rotate the N20 instead of performing the tool-return code)
M19 G00 G91 G49 G30 Z0;	(Spindle positioning, return to the tool-change coordinate point)

M21;	(Tool-return -> tool magazine rotation Tool forward Spindle tool-releasing)
N20 M19 G91 G49 G28 Z0;	(Return to the mechanical origin)
M22;	(Tool-searching -> tool magazine rotation Tool forward Spindle tool-releasing)
G91 G30 G49 Z0;	(Return to the tool-change coordinate)
N30 M17;	(Spindle tool-clamping)
M24;	(Tool magazine backward)
N50 M51;	(Tool-change end)
M99;	(Program end)
%	

APPENDIX II LADDAR DIAGRAM USE GUIDE OF GSK218MC SERIES MATCHING WITH DISC TOOL MAGAZINE

I. The application precautions of the disc tool magazine

- 1) Confirm each operation should be executed during tool-change, and then the next operation can be performed.
- 2) Do not perform the tool-pivoting before the tool magazine positioning inductor does not confirm.
- 3) Fail to start the motor of the tool magazine and rotate the cutter head if the tool-pivoting does not complete during performing.
- 4) Do not perform the tool-change before the tool-pivoting does not confirm.
- 5) Do not perform the tool-change when the machine spindle does not return to the tool-change point.
- 6) Do not perform the tool-change before the spindle positioning does not perform.
- 7) Fail to complete the tool-change operation, and do not move the spindle head before the tool arm does not return to the origin.
- 8) The overload protective relay should be firstly turned off avoiding the motor being burnt.
- 9) It is better to perform the tool-change with the manual method firstly, after checking the tool-case pivoting, tool-change mechanical operation and spindle tool-releasing/clamping, etc. are correct, and then perform the CNC automatic sequence program control.
- 10) Only the input/output signal (X and Y address) should be modified in the ladder diagram programming during debugging, the debugging requirement then can be completed. Do not modify others without any assurance to prevent the accident from generating.

II. The Configuration and Definition of the PLC I/O Address and Internal Soft Component

Table 1 The definition of input signal interface

Add.	Signal interface	Interface pin	Definition	Contact selection
X000.0	XS40	1	+ stroke limit signal along with the 1 st axis	NC contactor
X000.1	XS40	14	- stroke limit signal along with the 1 st axis	NC contactor

Add.	Signal interface	Interface pin	Definition	Contactor selection
X000.2	XS40	2	+ stroke limit signal along with the 2 nd axis	NC contactor
X000.3	XS40	15	- stroke limit signal along with the 2 nd axis	NC contactor
X000.4	XS40	17	+ stroke limit signal along with the 3 rd axis	NC contactor
X000.5	XS40	5	- stroke limit signal along with the 3 rd axis	NC contactor
X000.6	XS40	18	+ stroke limit signal along with the 4 th axis	NC contactor
X000.7	XS40	6	- stroke limit signal along with the 4 th axis	NC contactor
X001.0	XS40	8	The 1 st axis zero return deceleration signal	NC contactor
X001.1	XS40	21	The 2 nd axis zero return deceleration signal	NC contactor
X001.2	XS40	9	The 3 rd axis zero return deceleration signal	NC contactor
X001.3	XS40	22	The 4 th axis zero return deceleration signal	NC contactor
X001.4	XS40	24	ESP switch (218MC integration)	NC contactor
X001.5	XS40	12	External cycle start	NORM contactor
X001.6	XS40	25	External feed hold	NORM contactor
X001.7	XS40	13	Lubrication level or pressure detection	NORM contactor
X002.0	XS41	1	Air resource pressure detection	NORM contactor
X002.1	XS41	14	Skip signal	NORM contactor
X002.2	XS41	2	Index worktable releasing detection	NORM contactor
X002.3	XS41	15	Index worktable clamping detection	NORM contactor
X002.4	XS41	17	External tool clamping/releasing control	NORM contactor
X002.5	XS41	5	Tool-releasing detection	NORM contactor
X002.6	XS41	18	Tool-clamping detection	NORM contactor
X002.7	XS41	6	Undefined	NORM contactor
X003.0	XS41	8	Edit lock	NORM contactor
X003.1	XS41	21	Operation lock	NORM contactor
X003.2	XS41	9	Manipulator brake signal	Parameter specified
X003.3	XS41	22	Manipulator tool-hold detection signal	Parameter specified
X003.4	XS41	24	Manipulator zero detection signal	Parameter specified
X003.5	XS41	12	Undefined	NC contactor
X003.6	XS41	25	Undefined	NC contactor
X003.7	XS41	13	Undefined	NC contactor
X004.0	XS42	1	Undefined	
X004.1	XS42	14	Spindle gear I in-position	NORM contactor
X004.2	XS42	2	Spindle gear II in-position	NORM contactor
X004.3	XS42	15	Spindle gear III in-position	NORM contactor
X004.4	XS42	17	Undefined	
X004.5	XS42	5	Safety door detection switch	NORM contactor
X004.6	XS42	18	Undefined	
X004.7	XS42	6	Undefined	
X005.0	XS42	8	The 5th axis zero return signal detection	Parameter

Add.	Signal interface	Interface pin	Definition	Contact selection
				specified
X005.1	XS42	21	Tool case vertical detection	Parameter specified
X005.2	XS42	9	Tool case horizontal detection	Parameter specified
X005.3	XS42	22	Tool magazine counting switch	NORM contactor
X005.4	XS42	24	Undefined	NORM contactor
X005.5	XS42	12	Tool magazine zero return in-position detection	Parameter specified
X005.6	XS42	25	+ stroke limit signal along with the 5 th axis	NORM contactor
X005.7	XS42	13	- stroke limit signal along with the 5 th axis	NORM contactor
X006.0	XS22	5	The 1 st axis selection of the external MPG	NORM contactor
X006.1	XS22	23	The 2 nd axis selection of the external MPG	NORM contactor
X006.2	XS22	6	The 3 rd axis selection of the external MPG	NORM contactor
X006.3	XS22	24	The 4 th axis selection of the external MPG	NORM contactor
X006.4	XS22	8	External MPG step length 0.001	NORM contactor
X006.5	XS22	4	External MPG step length 0.01	NORM contactor
X006.6	XS22	9	External MPG step length 0.1	NORM contactor
X006.7	XS22	ESP (9, 22)	External ESP	NORM contactor
X007.0	XS23	44	Velocity/position shift completion	Parameter specified
X007.1	XS23	21	The completion of the spindle orientation	Parameter specified
X007.2	XS23	5	Spindle velocity arrival	Parameter specified
X007.3	XS23	20	Spindle zero velocity detection	NORM contactor
X008.0	XS22	7	The 5 th axis selection of the external MPG	NORM contactor

Precautions:

1. Refer to the Chapter Four for the connection and precaution of the PLC input section (X address).
2. The contactor selections are divided into: NORM, NC, Parameter determination (This input point that connects with the NORM or NC contactor is determined by the KAPA parameter in the PMC). Refer to the KAPA parameter introduction.
3. User can add new function to the undefined input section when using this ladder diagram (It is important to carefully operate it, and the ladder diagram should be modified when using the undefined section).
4. Operation panel USER1 button has 3 functions on 218MC:

When K11.0=0:

- a. When opening the 5th axis, it is the positive button

- b. If the 5th axis does not open, it is the chip-removal watering valve control switch

When K11.0=1: Manually return to the 1st reference position

USER1 button has two functions on 218MC-V:

When K11.0=0, it is the chip-removal watering valve control switch

When K11.0=1, Manually return to the 1st reference position

USER2 button has two functions on 218MC:

When K11.1=0:

- a. If the 5th axis does not open, it is the chip-removal watering valve control switch

- b. When opening the 5th axis, it is the negative button

When K11.1=1, Manually return to the 2nd reference position

USER2 button has two functions on 218MC-V:

When K11.1=0, If the 5th axis does not open, it is the chip-removal watering valve control switch

When K11.1=1, Manually return to the 2nd reference position

The function of the USER3 button: Spindle blowing start switch

Table 2 The definition of output signal interface

Add.	Signal interface	Interface pin	Definition
Y000.0	XS43	1	Z axis brake
Y000.1	XS43	14	Cooling
Y000.2	XS43	2	Tool releasing
Y000.3	XS43	15	Undefined
Y000.4	XS43	17	Spindle brake
Y000.5	XS43	5	Undefined
Y000.6	XS43	18	Red alarm indicator (It outputs when system alarms)
Y000.7	XS43	6	Yellow indicator (It outputs when system without alarm and operation)
Y001.0	XS43	8	Green indicator (It outputs when program operates)
Y001.1	XS43	21	Chip-removal control
Y001.2	XS43	9	Lubrication control
Y001.3	XS43	22	Machine illumination control
Y001.4	XS43	24	Hydraulic start
Y001.5	XS43	12	Spindle blowing
Y001.6	XS43	25	Index worktable releasing
Y001.7	XS43	13	Index worktable clamping
Y002.0	XS44	1	Undefined
Y002.1	XS44	14	Undefined
Y002.2	XS44	2	未定义 Undefined

Add.	Signal interface	Interface pin	Definition
Y002.3	XS44	15	Undefined
Y002.4	XS44	17	Undefined
Y002.5	XS44	5	Manipulator operation
Y002.6	XS44	18	Chip-removal watering valve output
Y002.7	XS44	6	Undefined
Y003.0	XS44	8	Tool magazine positive
Y003.1	XS44	21	Tool magazine negative
Y003.2	XS44	9	Tool case vertical
Y003.3	XS44	22	Tool case horizontal
Y003.4	XS44	24	Spindle gear I (Frequency-conversion\IO point control)
Y003.5	XS44	12	Spindle gear II (Frequency-conversion\IO point control)
Y003.6	XS44	25	Spindle gear III (Frequency-conversion\IO point control)
Y003.7	XS44	13	Undefined
Y004.0	XS45	1	Undefined
Y004.1	XS45	14	Undefined
Y004.2	XS45	2	Undefined
Y004.3	XS45	15	Undefined
Y004.4	XS45	17	Undefined
Y004.5	XS45	5	Undefined
Y004.6	XS45	18	Undefined
Y004.7	XS45	6	Undefined
Y005.0	XS45	8	Undefined
Y005.1	XS45	21	Undefined
Y005.2	XS45	9	Undefined
Y005.3	XS45	22	Undefined
Y005.4	XS45	24	Undefined
Y005.5	XS45	12	Undefined
Y005.6	XS45	25	Undefined
Y005.7	XS45	13	Undefined
Y006.0	XS23	9	Spindle positive
Y006.1	XS23	25	Spindle negative
Y006.2	XS23	24	Spindle enabling
Y006.3	XS23	11	Spindle orientation
Y006.4	XS23	12	Spindle velocity/position shift
Y006.5	XS23	27	Zero clamping

Precautions:

1. Refer to the Chapter Four for the connection and precaution of the PLC input section (Y address).
2. User can add new function to the undefined section by altering the ladder diagram when using this ladder diagram (It is important to carefully operate it, and the ladder diagram should

be modified when using the undefined section).

Table 3 The definition of KPRA address

Addr.	Definition	State 0	State 1	User setting value
K000.0	PLC parameter modification permission	Prohibition	Prohibition	
K000.1	PLC signal debugging permission	Prohibition	Permission	
K000.2	The overall Y signals are clear to 0 when PLC enters to the debugging mode	Reservation	Clear	
K000.3	A address information editing permission	Prohibition	Permission	
K000.4	K address information editing permission	Prohibition	Permission	
K000.5	X address information editing permission	Prohibition	Permission	
K000.6	Y address information editing permission	Prohibition	Permission	
K000.7	Command table operation permission	Prohibition	Permission	
K001.0	Tool magazine use permission	Prohibition	Permission	
K001.1	Whether it automatically downloads the ladder diagram when converting	No	Yes	
K001.2	The Level selection of spindle interface input signal	+24v enabling	0v enabling	
K002.0	Whether use the 4 th axis	Not use	Use	
K002.1	Whether use the 5 th axis	Not use	Use	
K004.0	Whether the spindle uses the shift control (I/O point)	Not use	Use	
K005.0	Whether the machine tool is with external MPG	Without	With	
K005.1	Whether the machine tool is with external cycle start	Without	With	
K005.2	Whether the system enters the debugging mode	No	Yes	
K006.0	Whether use 1 limit switch	2 pcs	1 pcs	
K006.4	Whether the zero return switch is selected the NORM type	No	Yes	
K007.3	Whether cancel the 4 th axis hart limit	No	Yes	
K007.4	Whether cancel the 5 th axis hart limit	No	Yes	
K007.5	Whether cancel the external ESP	No	Yes	
K007.6	Whether the spindle is output the +10V~-10V	No	Yes	
K007.7	Whether use the spindle position mode	Not use	Use	
K008.0	Whether the spindle positioning detection is NORM	NC	NORM	
K008.1	Whether the tool clamping/releasing is controlled by panel button	External button	Panel button	
K008.2	Whether not use the tool clamping/releasing equipment	Use	Not use	
K008.3	Whether use the safety door detection equipment	NC	NORM	
K008.4	Whether the spindle is with shift equipment	Without	With	
K008.5	Whether the spindle velocity arrival is NC type	NORM	NC	
K008.6	Whether it is the NC type when the spindle is velocity mode	NORM	NC	

Add.	Definition	State 0	State 1	User setting value
K008.7	Whether the spindle mode conversion is without detection signal	With	Without	
K009.0	Whether the spindle position arrival is without detection switch	With	Without	
K009.1	Whether the lubrication pressure or grease level detection is enabled	Not detection	Detection	
K009.2	Whether the air source pressure detection is enabled	Not detection	Detection	
K009.3	Whether the spindle gear detection is without detection switch	With	Without	
K010.1	Whether the tool magazine is with zero return switch	Without	With	
K010.2	Whether the tool magazine zero return switch is selected the NC type	NORM	NC	
K010.3	Whether the tool magazine infeed switch is selected the NC type	NORM	NC	
K010.4	Whether the tool magazine retraction switch is selected the NC type	NORM	NC	
K010.5	Whether the tool magazine counting switch is selected the NC type	NORM	NC	
K010.6	Whether the tool magazine origin set by manual is enabled	Disabled	Enabled	
K010.7	Whether the tool magazine enters the adjustment mode	No	Yes	
K011.5	Whether output the positive signal when spindle positioning	No	Yes	
K012.0	Whether the manipulator brake signal is selected the NC type	NORM	NC	
K012.1	Whether the manipulator tool-hold signal is selected the NC type	NORM	NC	
K012.2	Whether the manipulator zero return signal is selected the NC type	NORM	NC	
K012.3	Whether the current cutter head detection switch is NC type	No	Yes	
K012.7	Whether the manipulator enters the adjustment mode	No	Yes	
K014.0	Whether use the index worktable clamping/releasing equipment	No	Yes	
K014.1	Whether the worktable index is automatic clamping/releasing	No	Yes	
K014.2	Whether the worktable clamping/releasing is without detection switch	With	Without	
K014.3	Index worktable prohibits the manual MPG single block	Permission	Prohibition	

Add.	Definition	State 0	State 1	User setting value
K014.4	Whether the index worktable releasing state is permitted moving the X, Y and Z axes.	No	Yes	
K014.5	Whether cut off the output after the index worktable releasing/clamping is performed.	No	Yes	
K014.7	Index worktable enters the debugging mode	No	Yes	

Precautions:

1. Ensure the state of the K000.0, K000.1, K000.2, K000.3, K000.4, K000.5, K000.6, K000.7, K005.2、 K010.7 and K012.7 are set to 0 when the system is on the normal operation; otherwise, the unexpected accident may occur.
2. The modified K001.0 can be enabled after the system is restarted again. When K001.0=0 (that is: fail to use the tool magazine), the setting of the K010.1, K010.2, K010.3, K010.4, K010.5, K010.6 and K010.7 are disabled.
3. When K001.0=1 (that is: tool magazine enabled), K008.2 is disabled.
4. When K008.2=0 (that is, do not use the tool clamping/releasing equipment), K008.1 is disabled.
5. The precautions for setting the K006.0:

When K006.0 = 0 is enabled, there are two stroke limit switches along with each axis are installed.

For example: There are two stroke limit switches of the X axis are installed (+ limit switch connects with X0. 0; - limit switch connects with X0. 1).

When K006.0=1 is enabled, only one stroke limit switch of each axis is mounted.

For example: Only one stroke limit switch of the X axis is installed (It should be connected with the X0. 0).

Other installation methods of the limit switches of each axis are same as the above-mentioned.

6. When K005.2=1, the overall interlocking alarms are released, and then the system enters the debugging mode for using the test of the system; this parameter should be set to 0 if it is normally used; otherwise, otherwise, the unexpected accident may occur.
7. Refer to the Section Three for the usage and maintenance of tool magazine.
8. K004.0=1 (Whether the spindle is used the I/O point control); K008.4 is disabled (Whether the spindle is with the gear-shifting equipment), that is, the spindle gear-shifting equipment is disabled.
9. K012.7=1, the manipulator is on the unconditional movement state, it is better to move the Z axis to the machine zero position; in this case, do not put the cutter on the manipulator; it is better to disassemble it manually and then operate it. The previous method is only suitable for

the position of the manipulator debugging. In this moment, the data does not change, use it carefully.

Table 4 The definition of the PLC external alarm

PMC alarm No.	A add.	Alarm Content
1200	A000.0	Air pressure detection abnormality
1201	A000.1	Lubrication detection abnormality
1202	A000.2	Lubricating motor detection abnormality
1203	A000.3	Cooling motor overload
1204	A000.4	Chip-removal motor detection abnormality
1205	A000.5	Pressure grease pump motor detection abnormality
1207	A000.7	Machine illumination lamp detection abnormality
1208	A001.0	Machine controllable cabinet temperature detection abnormality
1209	A001.1	Machine body temperature detection abnormality
1210	A001.2	Machine vibration frequency detection abnormality
1211	A001.3	Pressure grease temperature detection abnormality
1212	A001.4	Excessive low of the pressure grease
1213	A001.5	Fail to ready the machine
1214	A001.6	Fail to rotate the spindle because its shift is abnormal
1215	A001.7	Firstly perform the T code and then execute the M06 code
1216	A002.0	Fail to rotate the spindle in the tool releasing state
1217	A002.1	Spindle rotation tool can not be released
1218	A002.2	Tool magazine abnormal stop, confirm the tool number again
1219	A002.3	Fail to rotate the spindle because the manipulator is out of the origin
1220	A002.4	Spindle tool clamping detection abnormality
1221	A002.5	Spindle tool releasing detection abnormality
1222	A002.6	Spindle unit temperature detection abnormality
1223	A002.7	Spindle velocity detection abnormality
1224	A003.0	Spindle motor enabling detection abnormality
1225	A003.1	Spindle orientation in-position detection abnormality
1226	A003.2	Spindle shift abnormality
1227	A003.3	Failure to cycle start because the manipulator is out of the origin position
1228	A003.4	Failure to cycle start because the tool case is in the vertical position.
1229	A003.5	Firstly perform the mechanical zero return when executing the M06 code
1230	A003.6	Fail to perform the tool-change when the spindle tool is in the releasing state
1231	A003.7	Fail to perform the tool-change when the tool case is not in the horizontal position
1232	A004.0	Tool magazine rotation in-position detection abnormality
1233	A004.1	Tool magazine rotation motor overload

PMC alarm No.	A add.	Alarm Content
1234	A004.2	Manipulator motor overload
1235	A004.3	Tool magazine motion in-position detection abnormality
1236	A004.4	Tool magazine zero turn detection abnormality
1237	A004.5	Tool magazine origin position lost, return to the zero again
1238	A004.6	Tool case horizontal/vertical detection abnormality
1239	A004.7	Fail to rotate the spindle because the tool case is out of the horizontal position
1240	A005.0	Tool magazine abnormality, return to the zero again
1241	A005.1	Tool case vertical direction detection abnormality
1242	A005.2	Tool case horizontal direction detection abnormality
1243	A005.3	Tool magazine zero position setting enabled
1244	A005.4	Tool-change abnormal stop to sure the normal tool magazine
1245	A005.5	There is no code tool number in the table or code tool number is repeated
1246	A005.6	Spindle releasing/clamping detection abnormality
1247	A005.7	Spindle orientation time-sequence detection abnormality
1248	A006.0	Adequate condition for T code tool number
1249	A006.1	Fail to infeed but the spindle is with tool
1250	A006.2	Fail to infeed because the current tool number is different between the spindle and tool magazine
1251	A006.3	Turn off the power
1252	A006.4	Do not move the Z axis when tool clamping
1253	A006.5	Carefully operate the tool magazine debugging mode
1254	A006.6	Do not cycle start in the tool magazine debugging mode
1255	A006.7	Fail to return to the origin when tool clamping
1256	A007.0	Fail to the tool-change position when tool clamping
1257	A007.1	Fail to return to the tool-change position because the spindle under positioning
1258	A007.2	Fail to return to the tool-change position because the tool abnormality
1260	A007.4	Do not cycle start in the manual tool-change position return
1261	A007.5	Fail to retract due to out of the origin
1262	A007.6	Exceed the safety position
1263	A007.7	Carefully operate the manipulator debugging mode
1264	A008.0	Spindle velocity position mode conversion abnormality
1265	A008.1	Spindle position velocity mode conversion abnormality
1267	A008.3	Fail to operated because the tool case does not vertical to the manipulator
1268	A008.4	Fail to operate because the manipulator does not at the origin
1269	A008.5	Manipulator operation abnormality interruption
1270	A008.6	Manipulator tool inspection abnormality
1271	A008.7	Fail to operate the manipulator because the spindle does not orientate
1272	A009.0	Fail to operate the manipulator because the spindle tool does not

PMC alarm No.	A add.	Alarm Content
		release
1273	A009.1	Fail to operate the manipulator because the spindle tool does not clamp
1274	A009.2	Do not perform the tool-pivoting because the manipulator does not at the origin
1275	A009.3	Do not perform the tool-retraction because the manipulator does not at the origin
1276	A009.4	Do not rotate the cutter-head because the manipulator does not at the origin
1277	A009.5	Do not rotate the cutter-head because the tool case does not put on the horizontal place
1278	A009.6	The manipulator can not be operated because the Z axis does not return to the 2 nd reference position.
1279	A009.7	Manipulator origin detection abnormality
1280	A010.0	Enforce to stop the rotation because the tool magazine rotation abnormality
1288	A011.0	Index worktable releasing/clamping detection overtime
1289	A011.1	Index worktable clamping/releasing detection abnormality
1290	A011.2	Fail to use the index worktable clamping equipment
1291	A011.3	Fail to rotate because the index worktable does not release
1292	A011.4	Fail to move because the index worktable does not clamp
1293	A011.5	Do not cycle start because the safety door opens
1294	A011.6	Do not shift in the rigid tapping, it is necessary to cancel the rigid tapping and then shift.
1360	A020.0	Low lubrication pressure grease level

The alarms between A0.0~A19.7 are the red interruption alarms of the system; the system stops after alarm. A20.0~A31.7 are the yellow prompt alarms for the user self-defined; the system continues after alarm without affecting the normal use.

The details of PMC section alarm diagnosis information:

Alarm information: 1200 Air pressure detection abnormality (A000.0)

Fault reason:

Troubleshooting: Detect the state of the X002.0

Alarm information: 1201 Lubrication detection abnormality (A000.1)

Fault reason: User self-defined

Troubleshooting:

Alarm information: 1202 Lubrication motor detection abnormal (A000.2)

Fault reason: User self-defined

Troubleshooting:

Alarm information: 1203 Cooling motor overload (A000.3)

Fault reason: Cooling motor overload

Troubleshooting: Check whether the cooling motor is normal, close the overload protective switch again after removing it.

Alarm information: 1204 Chip-removal motor detection abnormality (A000.4)

Fault reason: User self-defined

Troubleshooting:

Alarm information: 1205 Pressure grease pump motor detection abnormality (A000.5)

Fault reason: User self-defined

Troubleshooting:

Alarm information: 1207 Machine illumination lamp detection abnormality (A000.7)

Fault reason: User self-defined

Troubleshooting:

Alarm information: 1208 Machine control cabinet temperature detection abnormality (A001.0)

Fault reason: User self-defined

Troubleshooting:

Alarm information: 1209 Machine body temperature detection abnormality (A001.1)

Fault reason: User self-defined

Troubleshooting:

Alarm information: 1210 Machine vibration frequency detection abnormality (A001.2)

Fault reason: User self-defined

Troubleshooting:

Alarm information: 1211 Pressure grease temperature detection abnormality (A001.3)

Fault reason: User self-defined

Troubleshooting:

Alarm information: 1212 Excessive low of the pressure grease (A001.4)

Fault reason: User self-defined

Troubleshooting:

Alarm information: 1213 Machine does not ready (A001.5)

Fault reason: User self-defined

Troubleshooting:

Alarm information: 1214 Spindle shifting abnormal, fail to rotate (A001.6)

Fault reason: Detect the spindle shift abnormality when the spindle is performed the rotation code.

Troubleshooting: The gear I in-position detection switch (X004.1) does not close within the setting time of the T0021 when spindle changes the gear I (that is, Y3.4=1); adjust the time of the T0021 or check whether the X004.1 is closed. The gear I in-position detection switch (X004.2) does not close within the setting time of the T0022 when spindle changes the gear II (that is, Y3.5=1); adjust the T0022 time or check whether the X004.2 is closed. The gear I in-position detection switch (X004.3) does not close within the T0023 setting time when spindle changes the gear III (that is 3.6=1); adjust the T0023 time or check whether the X004.3 is closed.

Alarm information: 1215 Firstly perform the T code before executing the M06 code (A001.7)

Fault reason: Fail to perform the enabled T code when executing the M06 code.

Troubleshooting: Perform the M06 code after executing the enabled T code.

Alarm information:1216 Fail to rotate the spindle in the tool releasing state (A002.0)

Fault reason: Perform the spindle rotation code when the tool is on the releasing state. For example:

Press the spindle positive, negative, JOG and positioning in the manual mode or the spindle will be rotated by performing the M03, M04 and M19 in Auto state.

Troubleshooting: Press the “tool-clamping/tool-releasing” button to the tool-clamping state in the manual state (that is: Y0.2=0); check whether the state of the tool-clamping inspection switch (X2.6) is 1, if it does, this alarm will not generate by rotating the spindle.

Alarm information: 1217 Fail to release the tool when spindle rotates (A002.1)

Fault reason: The tool-releasing code is performed when the spindle is on the rotation state.

Troubleshooting: Perform the tool-releasing code to avoid this alarm when the spindle is on the stopping state.

Alarm information: 1218 Tool magazine abnormal stop, confirm the tool number again (A002.2)

Fault reason: This alarm will be generated after the alarm occurs or the "Reset" button is controlled when performing the Txx code and the tool magazine is being rotated.

Troubleshooting: 1. Tool magazine zero return again.

2. Reset the tool numbers both spindle and tool magazine.

(Refer to the details operation: Section Three The Usage and Maintenance of the GSK218MC Series with Disk Tool-magazine)

Alarm information: 1219 Fail to rotate the spindle because the manipulator is not at the origin (A002.3)

Fault reason: Perform the spindle rotation because the manipulator is not at the origin position.

Troubleshooting: 1. Manipulator returns to the origin position (Check whether the manipulator is on the origin position by inspecting the state of the X3.4).

2. It is convenient to debug when the manipulator is abnormally stopped during the operation; the manipulator can be performed the orientation in the mechanical zero. it is necessary to perform the mechanical zero return firstly when manipulator is not at the origin, and then perform the orientation.

(Refer to the details operation: Section Three The Usage and Maintenance of the GSK218MC Series with Disk Tool-magazine)

Alarm information: 1220 Spindle tool clamping detection abnormality (A002.4)

Fault reason: When performing the tool-clamping motion (that is: Y0.2=0), the tool magazine clamping detection switch (X2.6) does not close within the setting time of the T010.

Troubleshooting: 1. Check whether the tool-clamping detection switch is normal.

2. Check whether the Y0.2 is output.

3. Readjust the time of T010.

Alarm information: 1221 Spindle tool-releasing detection abnormality (A002.5)

Fault reason: When performing the tool-releasing motion ((that is: Y0.2=1), the tool magazine releasing detection switch (X2.5) does not close within the setting time of the T009.

Troubleshooting: 1. Check whether the tool magazine releasing inspection switch is normal.

2. Check whether the Y0.2 is output.

3. Readjust the time of T009.

Alarm information: 1222 Spindle unit temperature detection abnormality (A002.6)

Fault reason: User self-defined

Troubleshooting:

Alarm information: 1223 Spindle velocity detection abnormality (A002.7)

Fault reason: User self-defined

Troubleshooting:

Alarm information: 1224 Spindle motor enabling detection abnormality (A003.0)

Fault reason: User self-defined

Troubleshooting:

Alarm information: 1225 Spindle orientation in-position detection abnormality (A003.1)

Fault reason: When the spindle performs the positioning motion (that is: Y2.1=1), the spindle positioning detection switch (X7.1) is still connected within the setting time of the T013.

- Troubleshooting:
1. Spindle drive unit or spindle encoder abnormality.
 2. Check whether the Y6.3 is output.
 3. Readjust the time of the T013.

Alarm information: 1226 Spindle gear abnormality (A003.2)

Fault reason: Check the spindle gear abnormality

Troubleshooting: The gear I in-position detection switch (X004.1) does not close within the setting time of the T0021 when the spindle changes the gear I (that is: Y3.4=1), adjust the time of the T0021 or check whether the X004.1 is closed. The gear I in-position detection switch (X004.2) does not close within the setting time of the T0022 when the spindle changes the gear II (that is: Y3.5=1), adjust the time of the T0022 or check whether the X004.2 is closed. The gear I in-position detection switch (X004.3) does not close within the setting time of the T0023 when the spindle changes the gear I (that is: Y3.6=1), adjust the time of the T0023 or check whether the X004.3 is closed.

Alarm information: 1227 Do not to perform the cycle start because the manipulator does not at the origin position (A003.3)

Fault reason: If the manipulator does not at the origin position, press the “Start” button in the Auto, MDI or DNC mode, the alarm will occur.

Troubleshooting: Performing the manipulator returns to the origin.

Alarm information: 1228 Do not to perform the cycle start because the tool case on the vertical position (A003.4)

Fault reason: If the tool case is on the vertical position, press the "Start" button in the Auto, MDI or DNC mode, the alarm will occur.

Troubleshooting: Performing the tool case returns to the horizontal position.

Alarm information: 1229 Firstly perform the mechanical zero return before executing the M06 code (A003.5)

Fault reason: Perform the M06 or M50 code before the zero return does not execute.

Troubleshooting: Perform the mechanical zero return at the first time.

Alarm information: 1230 Failure to tool-change in the spindle tool-releasing state (A003.6)

Fault reason: Perform the M06 or M50 code when the spindle tool is at the releasing state (Y0.2=1).

Troubleshooting: Performing the spindle tool is at the clamping state (Y0.2=0).

Alarm information: 1231 Failure to tool-change because the tool case does not at the horizontal position (A003.7)

Fault reason: Perform the M06 or M50 code when the tool case does not at the horizontal position.

Troubleshooting: Performing the tool case returns to the horizontal position.

Alarm information: 1232 Tool magazine rotation in-position detection abnormality (A004.0)

Fault reason: User self-defined

Troubleshooting:

Alarm information: 1233 Tool rotation motor overload (A004.1)

Fault reason: The machinery in the operation processing is chucked or excessive big for the current when the tool magazine rotates the motor, the motor overload may cause.

Troubleshooting: Check whether the machinery of the tool magazine motor rotation is normal. Close the overload protective switch of the machinery tool magazine motor rotation again on the electric cabinet after the abnormality is removed.

Alarm information:1234 Mechanical arm motor overload (A004.2)

Fault reason: The machinery is chucked or the current is excessive big during the mechanical arm is performed, it may cause the overload of the motor.

Troubleshooting: Check whether the manipulator of the machine is normal. Close the overload protective switch of the machinery arm motor again on the electric cabinet after

the abnormality is eliminated.

Alarm information: 1235 Tool magazine movement in-position detection abnormality (A004.3)

Fault reason: User self-defined

Troubleshooting:

Alarm information: 1236 Tool magazine zero return detection abnormality (A004.4)

Fault reason: User self-defined

Troubleshooting:

Alarm information: 1237 Zero return gain because the tool magazine zero position is absent (A004.5)

Fault reason: The zero return abnormality stops so that the alarm occurs when the tool magazine performs the zero return.

Troubleshooting: Tool magazine returns to the zero again.

(Refer to the details operation: Section Three The Usage and Maintenance of the GSK218MC Series with Disk Tool-magazine)

Alarm information: 1238 Tool case horizontal/vertical detection abnormality (A004.6)

Fault reason: The tool case neither at the horizontal position nor at the vertical one.

Troubleshooting: Check whether the detection signal of X51 and X5.2 are normal.

Alarm information: 1239 Fail to rotate the spindle because the tool case does not at the horizontal position (A004.7)

Fault reason: Perform the spindle rotation when the tool case does not at the horizontal position.

Troubleshooting: Return the tool case to the horizontal position (Detecting the tool case returns to the horizontal position by inspecting the state of the X5.2), and then perform the spindle rotation.

Alarm information: 1240 Zero return again because the tool magazine abnormality (A005.0)

Fault reason: 1. The tool magazine counting switch (X5.3) abnormality is detected so that the pulse signal occurs after the tool magazine stops the setting time of rotating the T102.

2. When the tool magazine rotates, the tool magazine counting switch 0 or 1 is detected, which exceeds the setting time of the T103.

Troubleshooting: 1. The output section (Y3.0 and Y3.1) of the tool magazine's positive or negative are abnormal

2. Tool magazine counting switch abnormality.
3. Reset the values of the T102 and T103.

(Refer to the details operation: Section Three The Usage and Maintenance of the GSK218MC Series with Disk Tool-magazine)

Alarm information: 1241 Tool case vertical direction detection abnormality (A005.1)

Fault reason: The tool case vertical direction detection switch (X5.1) does not operate within the setting time of the T101 when performing the tool case vertical direction operation (that is: Y3.2=1).

Troubleshooting: 1. Check whether the vertical direction detection switch of the tool case is normal.
2. Check whether the Y3.2 is output.
3. Readjust the time of the T104.

Alarm information: 1242 Tool case horizontal detection abnormality (A005.2)

Fault reason: The tool case horizontal direction detection switch (X5.2) does not operate within the setting time of the T105 when performing the tool case horizontal direction operation (that is: Y3.3=1).

Troubleshooting: 1. Check whether the horizontal detection switch of the tool case is normal.
2. Check whether the Y3.3 is output.
3. Readjust the time of the T105.

Alarm information: 1243 Enabled setting of the tool magazine zero position (A005.3)

Fault reason: This alarm occurs when K010.6=1 in the case of the tool magazine is without the zero return switch (that is: K010.1=0); the tool magazine zero prompts the enabled setting.

Troubleshooting: Set the K010.6 to 0.

(Refer to the details operation: Section Three The Usage and Maintenance of the GSK218MC Series with Disk Tool-magazine)

Alarm information: 1244 Confirm the tool magazine is normal when tool-change stops abnormally (A005.4)

Fault reason: When the tool magazine is performed automatic tool-change, the abnormality occurs so that the tool-change stops or check the manipulator does not at the origin when starting the system, the alarm then occurs; this alarm is only shown that the operator tool magazine and the tool number on the spindle may be disorder already. The tool magazine may not normal after eliminating this alarm; it is better to set the tool magazine and the tool number on the spindle.

(Refer to the details operation: Section Three The Usage and Maintenance of the GSK218MC Series with Disk Tool-magazine)

Troubleshooting: Readjust the tool magazine and confirm the tool number on the spindle is consistent, which includes that whether the manipulator is on the origin position; whether the tool case returns to the horizontal position; whether the spindle is on the tool-clamping state; whether the current tool number is coincident with the current value of the CTR100 and whether the tool number on the spindle is different with the value of the D245.

Alarm information: 1245 There is no code tool number or the code tool number is repeated in the tool table (A005.5)

Fault reason: There is no the specified tool number by T code in the tool table (D000-D099) or the specified tool number by T code in the tool table is repeated.

Troubleshooting: Modify the tool number value in the tool table.

Alarm information: 1246 Spindle tool releasing/clamping detection abnormality (A005.6)

Fault reason: The spindle tool is neither at the releasing position nor at the clamping one.

Troubleshooting: Check whether the X2.5 and X2.6 are normal.

Alarm information: 1247 Spindle orientation time-sequence detection abnormality (A005.7)

Fault reason: The spindle orientation is firstly performed before the spindle does not orientate.

Troubleshooting: Check whether the signal of the X7.1 is normal.

Alarm information: 1248 Inadequate condition of the T code tool number (A006.0)

Fault reason: Fail to complete the 1st T code tool number, but the 2nd one is performed.

Troubleshooting: Perform the 2nd T code tool number after the 1st one is absolutely completed.

Alarm information: 1249 Fail to infeed because the spindle is with the cutter (A006.1)

Fault reason: Z axis is on the origin position and the spindle is with cutter (D245 is not treated as 0), the tool magazine infeed is then performed.

Troubleshooting: Disassemble the cutter on the spindle, and then set the D245 to 0.

Alarm information: 1250 Fail to infeed, because the current tool No. is different with the spindle (A006.2)

Fault reason: Z axis is at the tool-change position, the tool number on the spindle is inconsistent with the one of the tool magazine in the current tool case, and then perform the tool magazine infeed.

Troubleshooting: Rotate the tool magazine so that the tool number of the tool magazine on the current tool case is identical with the one on the spindle.

Alarm information: 1251 Turn off the power (A006.3)

Fault reason: The parameter should be enabled after restarting which is modified.

Troubleshooting: Restart the system.

Alarm information: 1252 Fail to move the Z axis at the tool clamping (A006.4)

Fault reason: When the manipulator is at the tool-hold position and the spindle tool is at the clamping state, the operation moved by Z axis is then executed.

Troubleshooting: 1. Put the manipulator on the origin.

2. Put the spindle tool on the releasing state.

Alarm information: 1253 Carefully operate the tool debugging mode (A006.5)

Fault reason: This alarm occurs when K010.7 sets to 1, which only prompts that the tool magazine enters the debugging mode; it is absolutely removed the relative tool magazine alarm and the interlocking signal, and therefore, carefully operate it; otherwise, the abnormality may occur, as well the machine will be damaged.

Troubleshooting: Clear this alarm by "Reset" button (Notice: It is not mean that the system is not on the tool magazine debugging mode after this alarm is eliminated; it is necessary to set the K010.7 as 0 when the tool magazine debugging mode should be retracted.

Alarm information: 1254 Do not perform the cycle start for the tool magazine debugging mode (A006.6)

Fault reason: When the value of the K010.7 is set to 1, press the "Start" button in the Auto, MDI or the DNC mode, the alarm generates accordingly.

Troubleshooting: Set the K010.7 to 0.

Alarm information: 1255 Fail to return to the origin of the tool clamping (A006.7)

Fault reason: When the tool magazine is at the infeed position and the spindle tool is in the clamping state, the origin position return along with the Z axis is then performed.

Troubleshooting: 1. Put the tool magazine at the tool-retraction position.

2. Put the spindle tool at the releasing state.

Alarm information: 1256 Fail to return the tool-change position of the tool clamping (A007.0)

Fault reason: When the tool magazine is at the infeed position and the spindle tool is in the clamping

state, the tool-change position return along with the Z axis is then performed.

Troubleshooting: 1. Put the tool magazine at the tool-retraction position.
2. Put the spindle tool at the releasing state.

Alarm information: 1257 Fail to return the tool-change position because the spindle positioning absence (A007.1)

Fault reason: When the tool magazine is in the infeed position and the spindle positioning does not perform, the tool-change position return along with the Z axis is executed.

Troubleshooting: 1. Put the tool magazine at the tool-retraction position.
2. Spindle positioning

Alarm information: 1258 Fail to return the tool-change position due to the tool magazine abnormality (A007.2)

Fault reason: User self-defined

Troubleshooting:

Alarm information: 1260 Do not perform the cycle start in the state of the tool-change position return by hand (A007.4)

Fault reason: When K011.1=1, press the "Start" button in the Auto, MDI or DNC mode, and the alarm may generate accordingly.

Troubleshooting: Set the K011.1 to 0.

Alarm information: 1261 Fail to retract due to out of the origin (A007.5)

Fault reason: When the tool magazine is at the infeed position and the Z axis does not at the origin, the tool magazine retraction is then performed.

Troubleshooting: Perform the tool-retraction after the Z axis returns to the origin.

Alarm information: 1262 Out of the safety position (A007.6)

Fault reason: Manipulator is at the tool-hold position, when Z axis moves, the Z axis exceeds the tool-change position.

Troubleshooting: Move the Z axis putting its coordinate between the tool-change and origin position.

Alarm information: 1263 Carefully operate the manipulator debugging mode (A007.7)

Fault reason: This alarm occurs when K012.7 set to 1, which only prompts that the manipulator enters the debugging mode, and the relative alarm with the tool magazine and the interlocking signal are absolute removed, carefully operate it; otherwise, the abnormality may occur, as well the machine will be damaged.

Troubleshooting: Set the K012.7 to 0 retreating from the manipulator debugging mode.

Alarm information: 1264 Spindle position mode conversion abnormality (A008.0)

Fault reason: When performing the M29 code, there is no completion signal of the spindle position mode within the setting time of the T24.

Troubleshooting: Regularize the setting time of the T24 or check whether the completion signal of the spindle position mode is output.

Alarm information: 1265 Spindle velocity mode conversion abnormality (A008.1)

Fault reason: When performing the M28 code, there is no completion signal of the spindle velocity mode within the setting time of the T28.

Troubleshooting: Regularize the setting time of the T28 or check whether the completion signal of the spindle velocity mode is output.

Alarm information: 1267 Fail to operate because the tool case does not vertical to the manipulator (A008.3)

Fault reason: The manipulator operation is performed when the tool case is not vertical.

Troubleshooting: Firstly perform the vertical operation of the tool case.

Alarm information: 1268 Fail to operate due to the manipulator does not at the origin (A008.4)

Fault reason: The manipulator operation is performed when it is not at the origin.

Troubleshooting: Set the K12.7 as 1, that is, the manipulator enters the debugging mode, return the manipulator to the origin by the button of the tool-change.

Alarm information: 1269 Manipulator operation abnormal interruption (A008.5)

Fault reason: The manipulator operation is abnormally interrupted by pressing the ESP, RESET button during the manipulator operation.

Troubleshooting: Set the K10.7 to 1, that is, tool magazine enters to the debugging mode, return the manipulator to the origin in the manual mode.

Alarm information: 1270 Manipulator tool-hold detection abnormality (A008.6)

Fault reason: The manipulator can not reach to the tool-hold position within the setting time of the T110 when it is performed the tool-hold operation; or the manipulator can not reach to the tool-hold position within the setting time of the T111 when it descends to rotate 180 degree.

Troubleshooting: Check whether the output of the Y2.5 is normal.

Check whether the input of the X3.3 is normal.

Alarm information: 1271 Fail to operate the manipulator due to the spindle does not orientate (A008.7)

Fault reason: Perform the manipulator operation when the spindle does not orientate.

Troubleshooting: Perform the spindle orientation at the first time.

Alarm information: 1272 Fail to operate the manipulator due to the spindle tool does not release

(A009.0)

Fault reason: The manipulator descends to rotate 180 degree when the spindle does not release the tool.

Troubleshooting: Check whether the output of the Y0.2 is normal.
Check whether the input of the X2.5 is normal.

Alarm information: 1273 Fail to operate the manipulator due to the spindle tool does not clamp (A009.1)

Fault reason: Perform the manipulator tool-hold operation or the manipulator return when the spindle does not clamp the tool.

Troubleshooting: Check whether the output of the Y0.2 is normal.
Check whether the input of the X2.6 is normal.

Alarm information: 1274 Failure to the tool-pivoting due to the manipulator does not at the origin (A009.2)

Fault reason: The tool position pivoting motion is performed when the manipulator does not at the origin.

Troubleshooting: Return the manipulator to the origin.

Alarm information: 1275 Fail to return the tool due to the manipulator is not at the origin (A009.3)

Fault reason: The tool position retraction is performed when the manipulator is not at the origin.

Troubleshooting: Return the manipulator to the origin.

Alarm information: 1276 Fail to rotate the cutter head due to the manipulator does not at the origin (A009.4)

Fault reason: The cutter head rotation is performed when the manipulator does not at the origin.

Troubleshooting: Return to the manipulator to the origin.

Alarm information: 1277 Fail to rotate the cutter head due to the tool case does not at the horizontal position (A009.5)

Fault reason: The cutter head rotation is performed when the tool case does not at the horizontal position.

Troubleshooting: Return the tool case to the horizontal position
Check whether the input of the X5.2 is normal.

Alarm information: 1278 Fail to operate the manipulator due to the Z axis does not return to the 2nd reference position (A009.6)

Fault reason: The manipulator motion is performed when the Z axis does not return to the 2nd reference position.

Troubleshooting: 1. The 2nd reference position return by performing the G30G91Z0.
2. When the manipulator is out of the origin, and in the case of the 2nd reference position can not be automatically returned by performing the G30G91Z0, and therefore, the 2nd reference position return only can be performed by hand (Return the Z axis to the mechanical zero in the zero return mode, then set the K11.1 to 1 (the manual tool-change position return allowed), the 2nd reference

point return manually can be performed pressing the "USER2" on the keyboard).

Alarm information: 1279 Manipulator origin detection abnormality (A009.7)

Fault reason: When the system is ON, the manipulator is not at the origin or the system command manipulator origin return does not gain the signal of the X3.4 within the setting time of the T110.

Troubleshooting: 1. Return the manipulator to the origin in the debugging mode.
2. Regularize the setting time of the T110

Alarm information: 1280 Enforce to stop the rotation due to the tool magazine rotation abnormality (A010.0)

Fault reason: 1. The pulse signal generated from the tool magazine counting switch (X5.3, X5.4) does not detect within the setting time of the T108 after the tool magazine sends out the rotation command.

2. When the tool magazine is rotated, the state of the counting switch 0 or 1 is detected, which exceeds the setting time of the T103

Troubleshooting: 1. The output section (Y3. 0 and Y3. 1) of the tool magazine positive or negative is abnormal.

2. The tool magazine counting abnormality.

Reset the value of the T108 and T103.

(Refer to the details operation: Section Three The Usage and Maintenance of the GSK218MC Series with Disk Tool-magazine)

Alarm information: 1288 Index worktable releasing/clamping detection overtime (A011.0)

Fault reason: Fail to receive the detection signal within the delay time.

Troubleshooting: Check the signal circuit, ensure the releasing/clamping signal input is normal.

Alarm information: 1289 Index worktable releasing/clamping detection abnormality (A011.1)

Fault reason: Input the releasing/clamping signal at the same time.

Troubleshooting: Check the signal circuit, ensure the releasing/clamping signal input is normal.

Alarm information: 1290 Index worktable clamping equipment does not use (A011.2)

Fault reason: When the index worktable clamping equipment does not use (that is: K12.4=0), the index worktable releasing or clamping motion command is performed.

Troubleshooting: After the K12.4 is set to 1, and then perform the index worktable releasing or clamping motion command.

Alarm information: 1291 Do not rotate the index worktable because it is clamped (A011.3)

Fault reason: When the index worktable is at the releasing state, the index worktable rotation is then performed.

Troubleshooting: Firstly, perform the index worktable clamping operation, then perform the index worktable rotation; or adjust the index worktable to the debugging mode (that is: K12.6 is set to 1), then perform the index worktable rotation.

Alarm information: 1292 Do not move the index worktable because it is released. (A011.4)

Fault reason: When the index worktable is at the releasing state, the feed axis performs the movement operation.

Troubleshooting: Firstly, perform the index worktable clamping operation, then perform the feed axis that it executes the movement operation; or adjust the index worktable to the debugging mode (that is: K12.6 is set to 1), then perform the feed axis that it executes the movement operation.

Alarm information: 1293 Do not perform the cycle start because the safety door is open (A011.5)

Fault reason: When the safety door detection equipment is used (that is, K8.3=1), the cycle start button is controlled when the safety door does not close (that is: X4.5=0)

Troubleshooting: Perform the cycle start before closing the safety door.

Alarm information: 1294 Do not perform the shift in rigid tapping, it is better to cancel the rigid tapping firstly, and then shift it. (A001.6)

Fault reason: Use the spindle shift equipment; Do not perform the M29 tapping command when shift is not in-position.

Troubleshooting: Perform the shift before cancelling the rigid tapping

Alarm information: 1360 Low lubrication pressure or grease level (A020.0)

Fault reason:

Troubleshooting: Detect the state of X001.7

Precaution: The alarm of the “User self-defined” in the fault cause, but this alarm does not design in the ladder diagram, so it is better to add by altering the ladder diagram.

Table 5 The definition of the TMR parameter

Add.	Note	Initial value (ms)	User setting value (ms)
T001	Spindle positive completion delayer	500	
T002	Spindle negative completion delayer	500	
T003	Spindle shift completion delayer	500	
T004	Spindle positioning completion delayer	0	
T005	Miscellaneous function completion delayer	0	
T006	Spindle shift delayer	500	
T007	Spindle tool releasing completion delayer	0	
T008	Spindle tool clamping completion delayer	0	
T009	Spindle tool releasing detection time	8000	
T010	Spindle tool clamping detection time	8000	
T011	M code miscellaneous function delay completion	50	
T012	T code miscellaneous function delay completion	50	

Add.	Note	Initial value (ms)	User setting value (ms)
T013	Spindle positioning detection time	8000	
T014	Spindle positive detection time	500	
T015	Spindle negative detection time	500	
T016	Lubrication OFF time setting (Unit: minute)	30	
T017	Lubrication ON time setting (Unit: second)	10	
T018	Spindle positioning delay detection time setting	2000	
T019	Spindle JOG delayer	2000	
T020	Program restart delayer	10	
T021	Spindle gear I delay detection time	10000	
T022	Spindle gear II delay detection time	10000	
T023	Spindle gear III delay detection time	10000	
T024	Spindle velocity position conversion detection time	10000	
T025	M29 execution completion time (It is enabled when there is no detection signal)	4000	
T026	The positioning completion time in the spindle position mode (It is enabled when there is no detection signal)	1500	
T027	M28 execution completion time (It is enabled when there is no detection signal)	2000	
T028	Spindle position velocity mode conversion detection time	10000	
T029	Spindle brake time	5000	
T030	The shift delay time when there is no detection switch in the spindle gear I	2000	
T031	The shift delay time when there is no detection switch in the spindle gear II	2000	
T032	The shift delay time when there is no detection switch in the spindle gear III	2000	
T033	The shift cancels the delay completion time when the spindle gear control is without detection switch	2000	
T034	M5 completion delay time	500	
T036	Index worktable releasing completion delay	500	
T037	Index worktable clamping completion delay	500	
T038	Index worktable releasing delay detection	5000	
T039	Index worktable clamping delay detection	5000	
T100	Tool magazine manual rotation delay time 1	2000	
T101	Tool magazine manual rotation delay time 2	2000	
T102	Tool magazine stops the delay detection time setting	2000	
T103	Tool magazine delay detection time setting 1	3000	
T104	Tool case vertical delay detection time setting	5000	
T105	Tool case horizontal delay detection time setting	5000	
T106	Tool case vertical completion delayer	0	
T107	Tool case horizontal completion delayer	0	

Add.	Note	Initial value (ms)	User setting value (ms)
T108	Tool magazine delay detection time setting 1	3000	
T109	Enforce to stop the time setting because the tool magazine rotation abnormal	5000	
T110	Manipulator tool-hold and original position return detection	2000	
T111	Manipulator falling tool-change delay detection	4000	

Table 6 The definition of the DATA parameter

(Tool magazine capacity is 24 cutters)

Add.	Description	Presetting value
D000	Spindle tool number display	
D001	No.1 tool case number	1 (The installed tool number inside the tool case)
D002	No.2 tool case number	2 (The installed tool number inside the tool case)
D003	No.3 tool case number	3 (The installed tool number inside the tool case)
D004	No.4 tool case number	4 (The installed tool number inside the tool case)
D005	No.15 tool case number	5 (The installed tool number inside the tool case)
D006	No.6 tool case number	6 (The installed tool number inside the tool case)
D007	No.7 tool case number	7 (The installed tool number inside the tool case)
D008	No.8 tool case number	8 (The installed tool number inside the tool case)
D009	No.9 tool case number	9 (The installed tool number inside the tool case)
D010	No.10 tool case number	10 (The installed tool number inside the tool case)
D011	No.11 tool case number	11 (The installed tool number inside the tool case)
D012	No.12 tool case number	12 (The installed tool number inside the tool case)
D013	No.13 tool case number	13 (The installed tool number inside the tool case)
D014	No.14 tool case number	14 (The installed tool number inside the tool case)

Add.	Description	Presetting value
D015	No.15 tool case number	15 (The installed tool number inside the tool case)
D016	No.16 tool case number	16 (The installed tool number inside the tool case)
D017	No.17 tool case number	17 (The installed tool number inside the tool case)
D018	No.18 tool case number	18 (The installed tool number inside the tool case)
D019	No.19 tool case number	19 (The installed tool number inside the tool case)
D020	No.20 tool case number	20 (The installed tool number inside the tool case)
D021	No.21 tool case number	21 (The installed tool number inside the tool case)
D022	No.22 tool case number	22 (The installed tool number inside the tool case)
D023	No.23 tool case number	23 (The installed tool number inside the tool case)
D024	No.24 tool case number	24 (The installed tool number inside the tool case)
D100	Tool magazine capacity	24
D241	T code tool number	Fail to set
D243	Current tool magazine tool case number	Fail to set
D245	Spindle tool number	

Precautions:

1. The setting value of the D100 should be less than 100, and it is identical with the setting value of the CTR100; otherwise, the abnormality may occur.

For example: When D100=16, the data table D001-D016 are enabled.

When D100=24, the data table D001-D024 are enabled.

2. D000 is only displayed the tool number of the spindle, instead of altering the tool number at the D000; it is better to modify at the 245 when spindle tool number modification is required.
3. Do not modify the value of the D241.
4. D240~D247 are used by system, and user can not self-defined.
5. Refer to the Section III for details.

Table 7 The definition of the CTR parameter

Add.	Presetting value	Current value	Function explanation
------	------------------	---------------	----------------------

C50	3	Current steps of the manipulator	Manipulator operation counting
C100	24	Current tool case number	Tool magazine counter (24TOOL)

Precaution:

1. The setting of CTR100 should be less than 100, and it should be identical with the D100; otherwise, the abnormality may occur.

For example: When CTR100=16, the tool case number of the tool magazine is 16.

When CTR100=24, the tool case number of the tool magazine is 24.

Table 8 The definition of the M code

M code	F signal	Function	Remark
M00	F031.7	Program dwell	
M01	F030.4	Selection stop	
M02	F030.5	Program end	
M03	F030.0	Spindle positive	
M04	F030.1	Spindle negative	
M05	F030.2	Spindle stop	
M06	F030.3	Automatic tool-change	
M08	F031.0	Coolant ON	
M09	F031.1	Coolant OFF	
M10	F031.2	A axis clamping	
M11	F031.3	A axis releasing	
M16	F026.0	Spindle tool-releasing code	
M17	F026.1	Spindle tool-clamping code	
M18	F028.3	Cancel the spindle exact stop	
M19	F026.2	Spindle exact stop code	
M20	F032.5	Spindle neutral position code (It is enabled when the gear control is without the detection switch)	
M22	F026.4	Manipulator operation start	
M23	F026.5	Tool case vertical command	Reserved
M24	F026.6	Tool case horizontal command	Reserved
M26	F027.5	Start the chip-removal watering valve	
M27	F027.6	Close the chip-removal watering valve	
M28	F032.3	Cancel the rigid tapping code	
M29	F032.2	Rigid tapping code	
M30	F028.0	Program end	
M35	F028.1	Start the spiral chip-removal transmitter	
M36	F028.2	Close the spiral chip-removal transmitter	
M44	F026.7	Spindle blowing start	
M45	F027.0	Spindle blowing stop	

M code	F signal	Function	Remark
M50	F027.1	Automatic tool-change start	
M51	F027.2	Automatic tool-change end	
M53	F027.3	Judge whether the tool is correct after tool-change.	Reserved
M55	F027.4	Judge whether the spindle is with the tool	Reserved
M56	F029.0	Manipulator to the tool-hold position	Reserved
M57	F029.1	Manipulator decreases then rotates to the 180 degree upgrade	Reserved
M58	F029.2	Manipulator returns to the origin	Reserved

Precautions:

1. The M codes marked with "F*** **" in the F signal column and with "Reserved" in the remark can be used.
2. M22 M50 M51 is only enabled in the tool-change, which can not be used alone. It is only can be operated in MDI method in the tool magazine mode.

III. The Usage and Maintenance with Manipulator Tool Magazine

1. Tool magazine installation and the relative PLC parameter setting

Operation purpose: The ladder diagram is suitable for the configuration of the tool magazine.

A. The requirements from machine tool when the ladder diagram matches with the disk tool magazine.

1. The machine tool is with the tool automatic clamping/releasing equipment, and the NORM in-position detection switch is installed on these equipments.
2. There is positioning function of the spindle, and its positioning angle can be adjusted.
3. The tool magazine capacity is less than 100.
4. Tool magazine can be performed the positive and negative.
5. The tool magazine is with the counting switch, tool case vertical in-position detection switch and tool case horizontal in-position detection switch.
6. Tool magazine is with the zero return switch (Optional)

B. The circuit connection related with the tool magazine.

1) Input section

Pin position	Signal interface	Add.	Pin function explanation	Remark
17	XS41	X002.4	External tool clamping/releasing control	Optional
5	XS41	X002.5	Tool releasing detection	NORM contactor
18	XS41	X002.6	Tool clamping detection	NORM contactor
9	XS41	X003.2	Manipulator brake signal	NORM or NC

22	XS41	X003.3	Manipulator tool-hold detection signal	NORM or NC
24	XS41	X003.4	Manipulator zero detection signal	NORM or NC
21	XS42	X005.1	Tool case vertical detection	NORM or NC
9	XS42	X005.2	Tool case horizontal detection	NORM or NC
22	XS42	X005.3	Tool magazine counting (Constant 0)	NORM contactor
12	XS42	X005.5	Tool magazine zero return in-position detection	Optional
21	XS23	X007.1	Spindle orientation in-position	NORM or NC

2) Output section

Pin position	Signal interface	Mark	Pin function explanation
2	XS43	Y000.2	Tool releasing/clamping
5	XS44	Y002.5	Manipulator operation
8	XS44	Y003.0	Tool magazine positive
21	XS44	Y003.1	Tool magazine negative
9	XS44	Y003.2	Tool case vertical
22	XS44	Y003.3	Tool case horizontal
11	XS23	Y006.3	Spindle orientation

C. The selection of the tool magazine switch type

Add.	Definition	Sate 0	State 1
K010.1	Whether the tool magazine is with the zero return switch	Without	With
K010.2	Whether the tool magazine zero return switch is selected the NC type	NORM	NC
K010.3	Whether the tool magazine infeed switch is selected the NC type	NORM	NC
K010.4	Whether the tool magazine retraction switch is selected the NC type	NORM	NC
K010.5	Whether the tool magazine counting switch is selected the NC type	NORM	NC

For example: There is no zero return switch on a disk tool magazine, and each detection switch is NORM, its parameter should be set as:

K010.1=0 K010.2=0 K010.3=0 K010.4=0 K010.5=0

D. The setting of the tool magazine capacity

Input the tool magazine capacity in the DATA100 and CTR100.

Precautions:

1. Tool magazine capacity is the tool case numbers in the tool magazine.

2. The setting value of the DATA100 and CTR100 should be less than 100.

For example: The DATA100 and CRT100 are set to 24 when tool magazine capacity is 24.

E. The setting of the tool number in the tool magazine:

D001--D099 in the data table are separately corresponding to the tool case No. 1 to 99 in the tool magazine. The setting values in the data table D001--D099 are separately corresponding to the tool number of the No. 1 to 99 tool case in the tool magazine. D245 is the tool number on the spindle.

Precautions:

1. Fail to set the same tool number (other than the 0) in the D001--D099; otherwise, the alarm occurs when tool-change.

2. The setting range of the tool number should be suitable for the setting requirement of the data parameter 0206; otherwise, the alarm may occur when performing the T code.

For example: If the tool magazine capacity is 24 and the D1-D24 will be set as 1—24 in turn; the No. 8 tool case will perform the tool change after rotating to the tool-change position when executing the T8M6. If it is set to 10, 20, 30... 240 in the D1—D24 in turn, the No. 8 tool case will perform the tool change after rotating to the tool-change position when executing the T80M6. If both the D1 and D2 are set to 8, the alarm may occur when performing the T8M6.

F. The setting of the time parameter (TMR) related with the tool magazine

Add.	Note	Setting range	Initial value (ms)
T004	Spindle positioning completion delayer	More than or equal to 0	0
T007	Spindle tool releasing completion delayer	More than or equal to 0	0
T008	Spindle tool clamping completion delayer	More than or equal to 0	0
T009	Spindle tool releasing detection time setting	More than the tool releasing time	8000
T010	Spindle tool clamping detection time setting	More than the tool clamping time	8000
T013	Spindle positioning detection time setting	More than the positioning time	8000
T018	Spindle positioning delay detection time setting	It is related with the positioning width	2000
T036	Index worktable releasing completion delay	More than or equal to 0	500
T037	Index worktable clamping completion delay	More than or equal to 0	500
T038	Index worktable releasing delay detection	More than or equal to 0	5000
T039	Index worktable clamping delay detection	More than or equal to 0	5000
T040	Index worktable releasing delay completion	More than or equal to 0	4000
T041	Index worktable clamping delay completion	More than or equal to 0	4000

Add.	Note	Setting range	Initial value (ms)
T100	Too magazine manual rotation delay time 1	More than a tool position rotation time	2000
T101	Too magazine manual rotation delay time 2	More than a tool position rotation time	2000
T102	Tool magazine stop delay detection time	More than a tool position rotation time	2000
T103	Tool magazine rotation delay detection time 1	More than a tool position rotation time	3000
T104	Tool case vertical delay inspection time setting	More than tool case vertical time	5000
T105	Tool case horizontal delay inspection time setting	More than tool case horizontal time	5000
T106	Tool case vertical completion delayer	More than or equal to 0	0
T107	Tool case horizontal completion delayer	More than or equal to 0	0
T108	Tool magazine rotation delay detection time 2	More than a tool position rotation time	3000
T109	Enforce the stop time because the tool magazine rotation abnormal	More than a tool position rotation time	5000
T110	Manipulator tool-hold and original position return delay detection	More than the manipulator's time from the origin to the tool-hold	2000
T111	Manipulator falling tool-change tool delay detection	More than the time from the manipulator's falling to the rotation 180 degree upgrading.	4000

Appendix

Precautions:

1. The above-mentioned parameters (TMR) are related with the type and the rotation velocity of the tool magazine, it is better to reasonably set it based upon the performance index of the tool magazine.

2. If the above-mentioned parameters (TMR) are set incorrectly, it may cause the alarm so that it can not be normally performed the tool-change.

The ladder diagram is suitable for the configuration of the tool magazine based upon the basis operations from A to F, however, the tool magazine does not normally operate yet. The tool magazine can be performed the positive, negative, pivoting and retraction in the manual operation mode by the setting and operation at the 2nd section, so that check whether each motion of the tool magazine is normal.

2. The manual and zero return operation of the tool magazine

Operation purpose: Check whether each motion of the tool magazine is normal.

Refer to the detailed operation steps:

A. Tool magazine usage enabled

1. Use the Ladder01.grp ladder diagram in the system default state, that is, cone tool magazine ladder diagram. It is necessary to use the Ladder00.grp ladder diagram when using the disk tool magazine, that is, bit parameter NO: 53 #0=0, NO: 53 #1=0, NO: 53 #2=0 and NO: 53 #3=0. The system should be restarted after the power is turned off till the parameters are altered.

2. The KPAR parameter K001.0 of the PMC is set as 1.

B. Tool magazine enters the adjustment mode

1. The KPAR parameter K012.7 of PMC set as 1.

In order to convenient the debugging between tool magazine tool-clamping position and spindle concentricity and the Z axis tool-capture position, set the tool magazine debugging PMC parameter. When K012.7 set to 1, the condition limit of the manipulator motion can be cancelled, and then enter the tool debugging state. It is better to set the K012.7 as 0 after debugging. In this case, the data does not change each other)

2. Normally, the steps of the manual operation manipulator

Z axis returns to the tool-change point. (In the MDI mode, input G30G91Z0 to return to the manipulator tool-change point). Set the K10.7 as 1.

Spindle orientation. (In the manual mode, press  to complete the orientation)

Tool case vertical. (In the manual mode, press  to perform the tool case vertical in-position)

Manual manipulator motion tool-clamping. (In the manual mode, press the “Tool-change manipulator” button to complete the manipulator motion 1)

Tool-releasing. (In the manual mode, press the  to release the tool, and then perform to the in-position)

Manual manipulator motion tool-change. (Press the  again to complete the manipulator motion 2)

Tool-clamping. (Press the  again to clamp the tool, and then perform to the in-position)

Manual manipulator motion returns to the manipulator origin. (Press the  thrice to complete the manipulator motion 3)

The completion of the manual manipulator motion

Generally, the manual operation manipulator conditions:

The completion of the spindle orientation, tool case vertical in-position, Z axis returns to the tool-change point

C. The affirmation of the tool magazine rotation direction



In the manual mode, press , tool magazine rotates by increasing the tool numbers;



press , tool magazine rotates by decreasing the tool numbers; otherwise, the tool magazine counting may disorder, so that the tool-change is incorrect. This troubleshooting can be solved by adjusting the motor's phase-sequence of the tool rotation.

D. The zero return operations of the tool magazine



The zero return operation of the tool magazine is divided into: with the zero return switch and without the zero return switch.



1. When the tool magazine is with the zero return switch: press  in the "Mechanical zero return" mode; the zero return completion (That the indicator flashes means the tool magazine is performing the zero return) when "tool magazine zero return indicator" is ON.

2. When the tool magazine is without the zero return switch, set the tool magazine zero based upon the following steps:



a. Press the  or  in the manual mode, so that the No.1 tool case of the tool magazine rotates to the place of the tool change.

b. Set the O10.6 to 1 in the MDI mode.



c. In the mechanical zero return mode, press  till "Tool magazine zero return indicator" ON.

d. Set K010.6 to 0.

3. The adjustment between the spindle positioning angle and tool-change coordinate position

A. The adjustment of the spindle positioning angle (Refer to the relative User Manual of the spindle drive unit)

The adjustment method of the DAP03 positioning angle:

- 1) Turn on the controllable equipment, LED displays by default: ;
- 2) Enter the monitoring method by , display: ;
- 3) There are 25 display states of the monitoring method, select the desired state by , .
Find out the (Here, find out the when the motor's encoder is treated as the positioning encoder, and the spindle encoder is also regarded as positioning encoder), then press , the is then displayed.
- 4) In this case, the motor is on the free state, directly rotate the motor's rotor or connect it on the spindle, and then rotate the motor's rotor one circle at least; at this moment, the drive unit may automatically search the correct position of the motor encoder; the monitoring display then becomes after searching the correct position.
- 5) Rotate the motor more than one circle based upon the above-mentioned methods, and then slightly adjust so that the positioning place of the motor (spindle) rotor is at the positioning point. Stop the operation to observe the absolute position of the rotor. In this case, the monitoring is . Save this numerical value in the parameter PA58, that is, it is the positioning place.

Note: If the monitoring displays , the symbol 'E' means that the motor rotor is at the incorrect positioning place, and its value can not be regarded as the positioning place reference value. Rotate the motor's rotor one circle at least, the drive unit will automatically search the correct position of the motor encoder; after found it, the monitoring display becomes .

B. The tool magazine tool-change position coordinate I set in the system parameter 0052, which should be set this parameter correctly; otherwise, the unexpected hazard may occur to cause the machine damage.

The correct tool-change operation can be performed based upon the above-mentioned three steps. The operation description of the T and M codes are shown below:

```

Program 1: TXXM6;      Program 2: TXX;
                          G54 G90;
                          X100, Y100;
                          .....
                          .....
                          M6;
                          } Machining program
    
```

The tool-change is same when performing the above-mentioned two programs.

The following program formats are incorrect:

T1;

T2;

M6;

4. The manual adjustment after the tool magazine is abnormally stopped.



The manipulator zero return should be adjusted again when the manipulator is power off during the operation or the ESP, Reset button is controlled. Firstly, set the K010.7=1, so that the tool magazine enters the adjustment state, and then adjust the manipulator zero return based upon the manual manipulator steps; if it can not be eliminated, set K012.7=1, so that the manipulator enters the adjustment state, in this case, the overall limit conditions of the manipulator operations are released; it is necessary to operate it carefully. Set K010.7=0, K012.7=0 after the manipulator performs the zero return, and therefore the manipulator can be normally operated.

The KPAR parameter setting explanations of PMC:

1. Input the system debugging password. Press the , then the [Password] software entering the "Setting (password)" interface. Input the system debugging password in the MDI mode,

and then press . The "Password correct" prompts at the left corner of the screen.

2. Press the  key on the MDI keyboard, then press the [KPAR] soft key in the [PLCPAR] interface, and then enter the view and setting interface of the non-volatile relay. Press the 4 direction buttons on the keyboard to position the cursor to the K010.7, then press the digit "1" then the

, and then press the , the data column prompts: "KPAR download successful!" means the storage is performed, and the tool magazine adjustment mode is then enabled. Retreat from the tool magazine adjustment mode by setting the K010.7 to 0.

IV. Macro Note with Disk Tool Magazine

- O91000; (Program name)
- G65 H81 P10 Q#1000 R1; (Miscellaneous lock Machine lock, Rotate the N10 instead of performing the program end of the tool-change operation when Spindle tool number =T code tool number)
- G69 G50 G15 G80G40;
- M50; (Tool-change begins, simultaneously, check whether the

tool-change condition is suitable, if does not, the alarm may occur)

M19 G00 G91 G49 G30 Z0; (Spindle positioning, return to the tool change coordinate point)

M22; (Manipulator operation begins)

N10 M51; (Tool-change end)

M99; (Program end)

%

APPENDIX III FILE FORMAT OF LADDER DIAGRAM CONFIGURATION

The signal in the ladder diagram configuration file **LadChixx.txt** (“xx” is corresponding to the ladder diagram file number set by system) stores the following information in terms of the fixed sequence.

I. F Signal and Meaning of the M Code M00---M99

Format: Mxx + Space + Fyyy + Space + Chinese note + Enter character (Enter)

For example: “M00 F0317 Program dwell”

Wherein: “xx” is 00, 01, 02... 99 in turn, total 100 numbers and its sequence can not be altered. Normally, the “Space” is one space and can not add other characters.

“yyy” means the M code corresponding the value of the F signal, for example: F0317 means F31.7”, it can be set from 026 to 0337 (that is, the F signal is from 26.0 to 33.7). If it is set to “-001”, it will not be registered, and the system will not identify the M code. “Up to 32 Chinese characters, it also can be set as 16 Chinese characters or the equivalent Chinese characters + Characters. The following descriptions are identical.

“Enter character” means the end of this line, and the following characters will not be identified. It is same as the following descriptions.

II. That the “%” Takes One Single Line Means that the M code Information Storage is End

III. The Code and Meaning of the X Signal X0.0---X6.7

Format: Xxxxx + Space + Chinese note + Enter character (Enter)

For example: “X0000 + stroke limit signal along with X axis”

Wherein: “xxx” means the value of the X signal, for example: “0000 means 0.0”, “0067 means 6.7”, it is from 0000 to 0067 in turn (that is, the X signal is from 0.0 to 6.7) and its sequence can not be altered.

Normally, the “Space” is 5 spaces, and can not add other characters, the following descriptions

are identical.

IV. The Code and Meaning of the Y Signal Y0.0---Y5.7

Format: Yxxxx + Space + Chinese note + Enter character (Enter)

For example: “Y0000 Z axis brake”

Wherein: “xxxx” means the value of the Y signal, for example: “0000 means 0.0”, “0057 means 5.7”, it is from 0000 to 0057 in turn (that is, the Y signal is from 0.0 to 5.7) and its sequence can not be altered.

V. The Code and Meaning of the K Signal K6.0---K63.7

Format: Kxxxx + Space + Chinese note + Enter character (Enter)

For example: “K0060 Whether uses one X axis limit switch”

Wherein: “xxxx” means the value of the K signal, for example: “0060 means 6.0”, “0637 means 63.7”, it is from 0060 to 0637 in turn (that is, K signal is from 6.0 to 63.7) and its sequence can not be altered.

Normally, the “Space” is 5 spaces and can not add other characters.

VI. The Code and Meaning of the A Signal A0.0---A31.7

Format: Axxxx + Space + Chinese note + Enter character (Enter)

For example: “A0000 Air pressure detection abnormality”

Wherein: “xxxx” means the value of A signal, for example “0000 means 0.0” “0317 means 31.7”, it is from 0000 to 0317 in turn (that is, A signal is from 0.0 to 31.7) and its sequence can not be altered.

Normally, the “Space” is 5 spaces and can not add other characters.

VII. end//End Mark

Note: The above-mentioned information should be written at the top of the line; refer to the in-built file LadChixx.txt for details. The unique difference in the corresponding English file LadEng01.txt is that the Chinese notes are changed into 32 English letters or characters.

CNCmakers Limited

Address: No.168, Xiadu Road, Haizhu District, Guangzhou, China 510300

Email: info@CNCmakers.com Website: www.CNCmakers.com Tel: +86-138-24444158 Fax: +86-20-84185336